



# MONKIE KID 悟空小侠

80046



 **WARNING: CHOKING HAZARD.**  
Toy contains small parts and a small ball.  
Not for children under 3 years.



### **Get excited about our new packaging!**

We're switching from plastic to paper-based packaging. That's why you might find a mix of paper and plastic in our boxes!

### **Nos nouveaux emballages vous emballeront !**

Nous passons des emballages en plastique aux emballages à base de papier. C'est pourquoi vous pourriez trouver un mélange de papier et de plastique dans nos boîtes !

### **¡Te presentamos nuestros nuevos empaques!**

Estamos sustituyendo las bolsas de plástico por bolsas con base de papel. ¡Por eso, puedes encontrar una mezcla de papel y de plástico en nuestras cajas!

**[LEGO.com/sustainable-packaging](https://www.lego.com/sustainable-packaging)**



# BUILDER



Apple and the Apple logo are trademarks of Apple Inc., registered in the U.S. and other countries and regions. App Store is a service mark of Apple Inc. Google Play and the Google Play logo are trademarks of Google LLC. Tencent and the Tencent logo are trademarks of Tencent, Inc.

LEGO.com/devicecheck

EN Ask parents' permission before going online | DE Eltern um Erlaubnis bitten, bevor du online gehst | FR Demande l'autorisation d'un parent avant d'aller en ligne | IT Chiedi il permesso ai tuoi genitori prima di andare online | ES Pídeles permiso a tus papas antes de conectarte a Internet | PT Pede autorização aos pais antes de acederes online | ZH 上网前应先征得父母的同意 | PL Poproś rodziców o zgodę, zanim wejdiesz do Internetu | CS Než půjdeš na internet, požádej rodiče o svolení | SK Skôr než pôjdeš na internet, vypýtaj si povolenie od rodičov | HU Kérj szülői engedélyt, mielőtt online csatlakoznál! | RO Cere permisiunea părinților înainte de a te conecta online | BG Поискайте разрешение от родител, преди да влезете онлайн | LV Pirms došanās tiešsaistē palūdz atļauju vecākiem | ET Enne Interneti kasutamist küsi vanemalt luba | LT Prieš prisijungdami prie interneto, atsklauskite tėvų

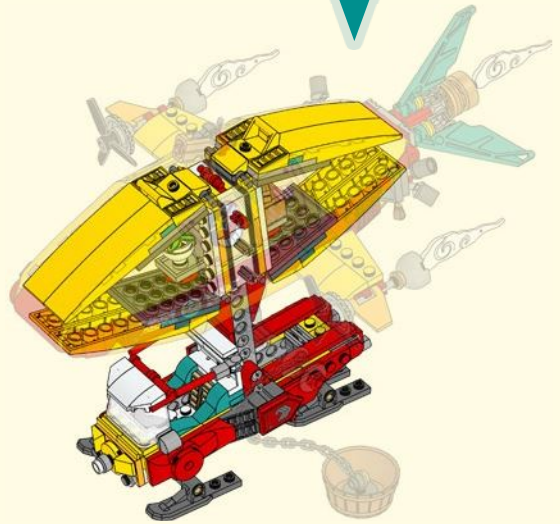
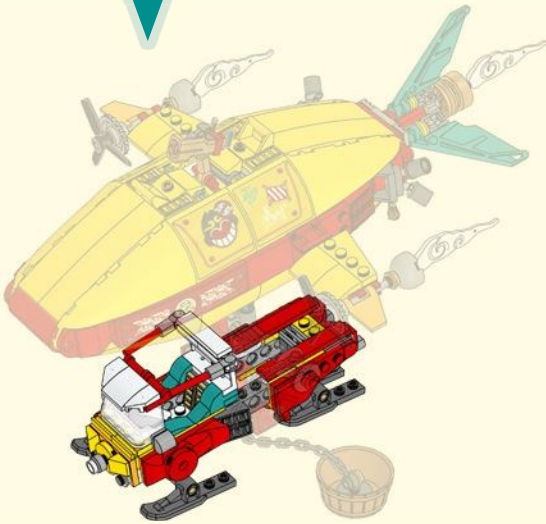



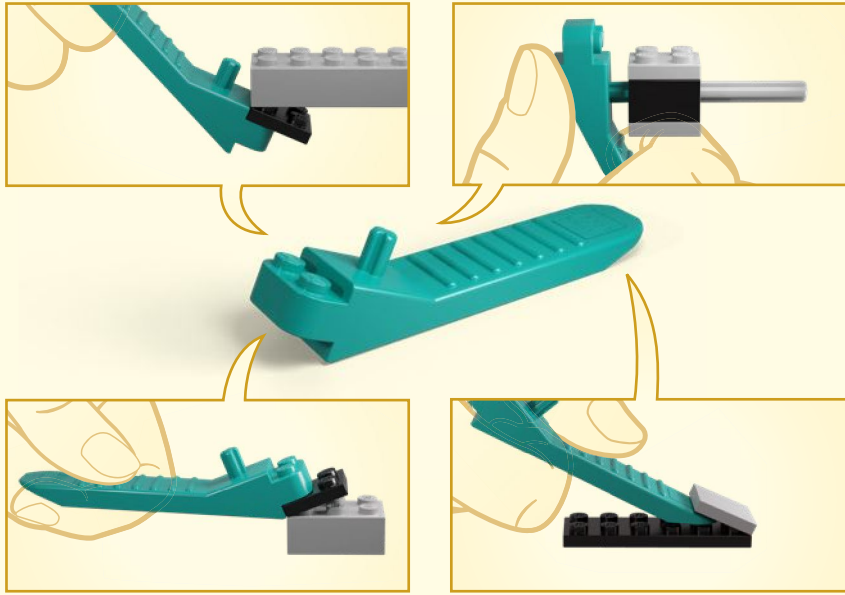

- ⚠️ **AVERTISSEMENT : RISQUE D'ÉTOUFFEMENT.**  
Le jouet contient des petites pièces ainsi qu'une petite boule.  
Il ne convient pas aux enfants de moins de 3 ans.
- ⚠️ **ADVERTENCIA: PELIGRO DE ASFIXIA.**  
Juguete que contiene partes pequeñas y una pelota pequeña.  
No recomendado para niños menores de 3 años.



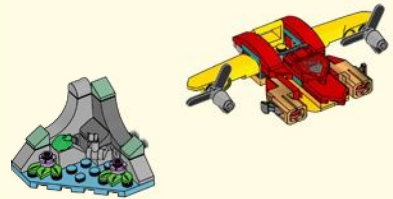
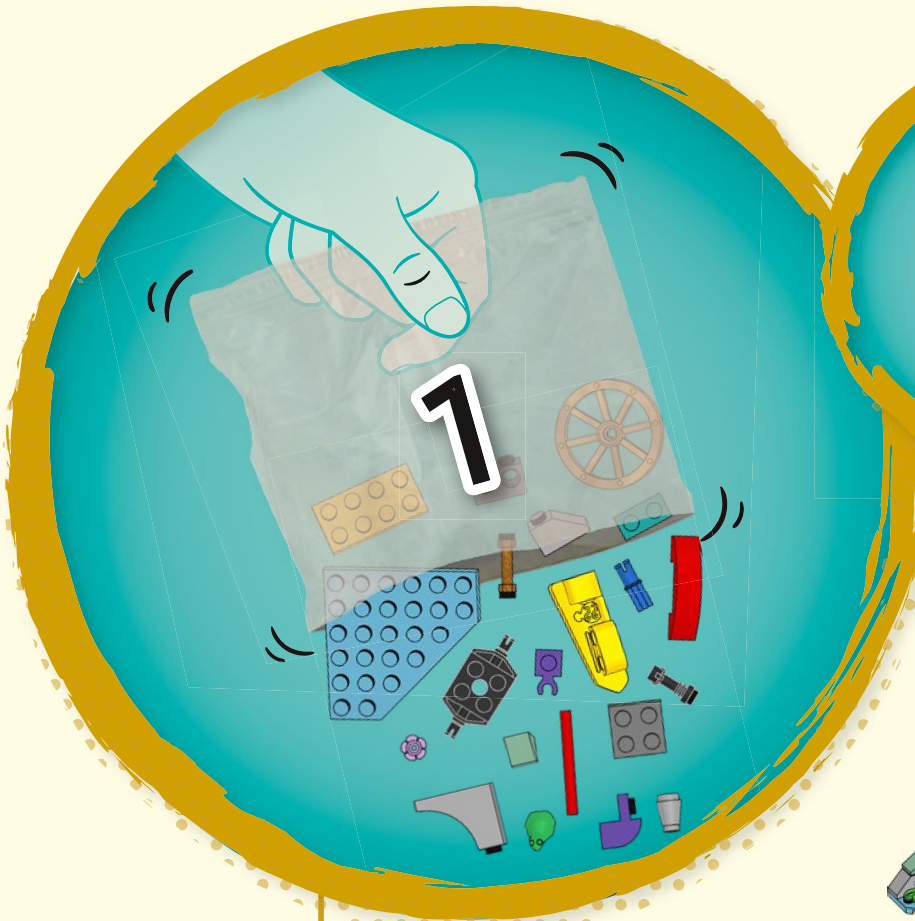
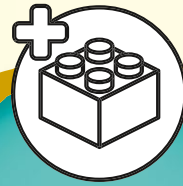



1



2





# MONKIE KID





1x



1x

1

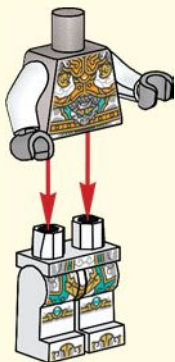

1x



1x



1x



1x

2

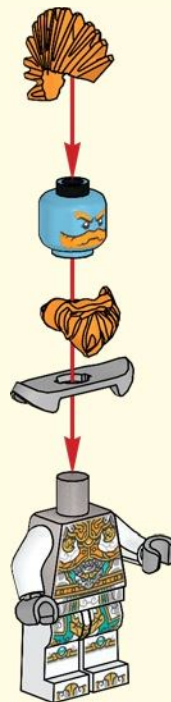

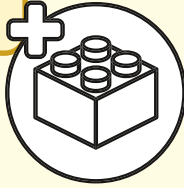

3

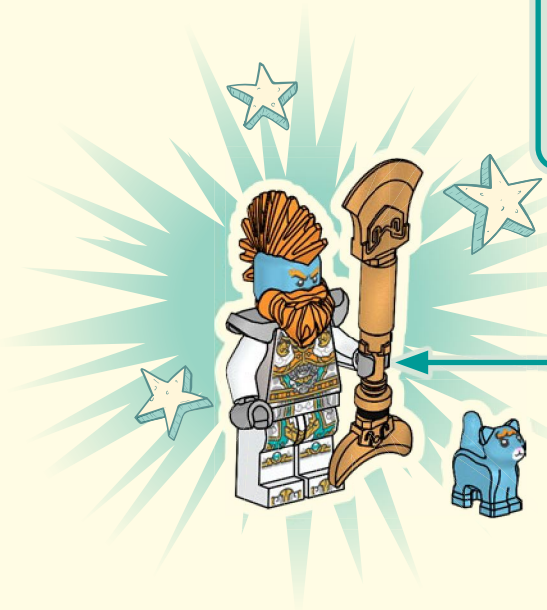
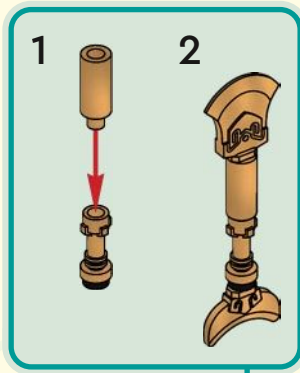



1x

1

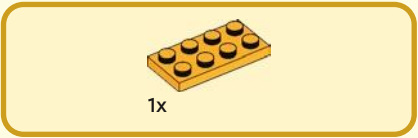

1x

2



1x

3

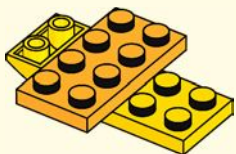



2x

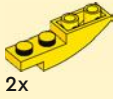

2x

4

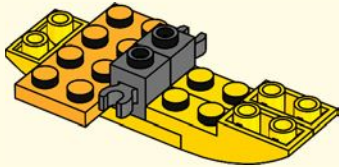

1x



1x

5

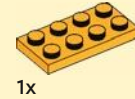
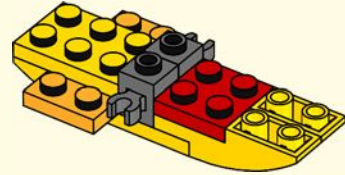

1x



2x

6

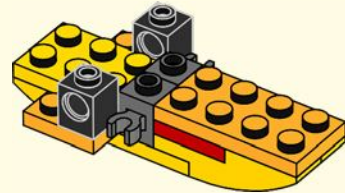



1x



2x

7

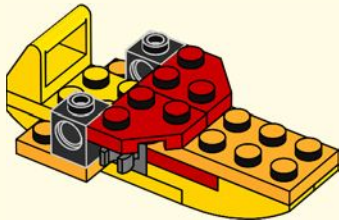

2x



2x

8

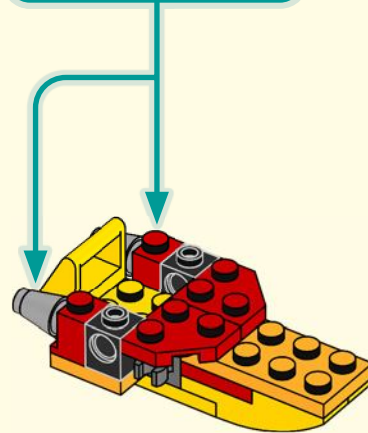
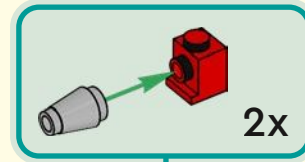

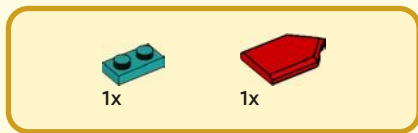

9

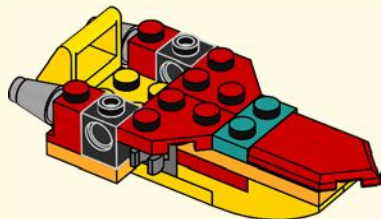

10

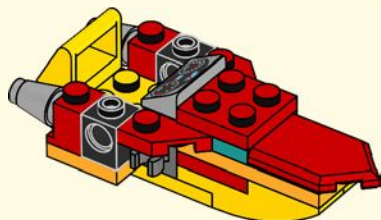

11

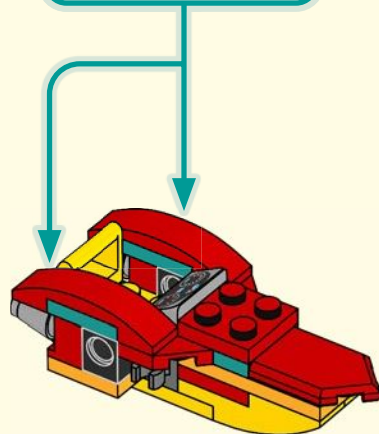
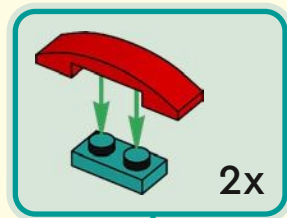

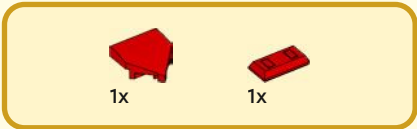

12

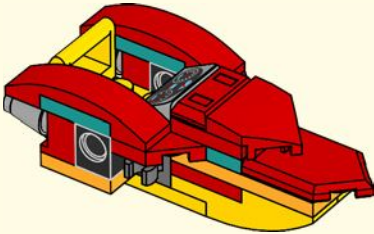

13

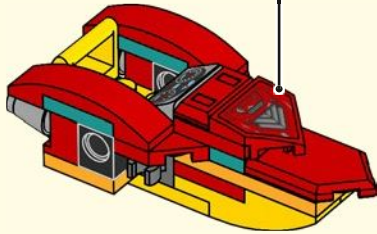



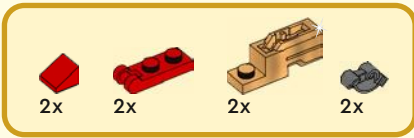

14

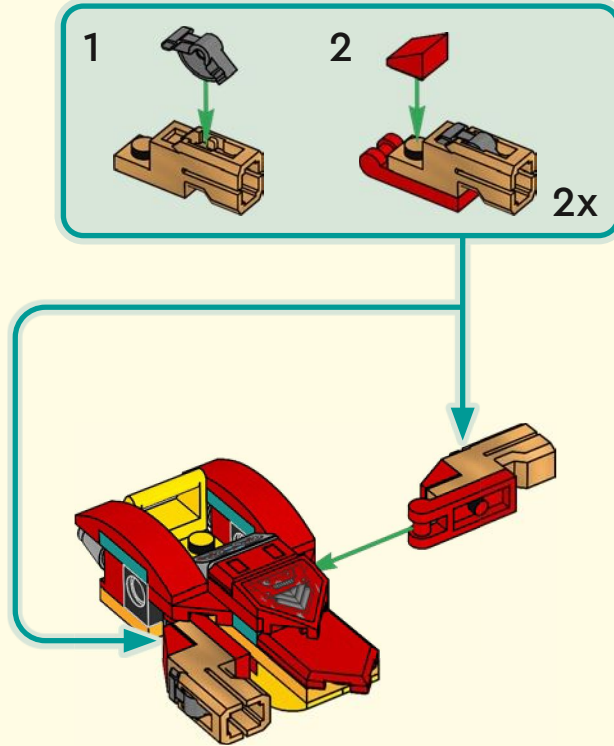

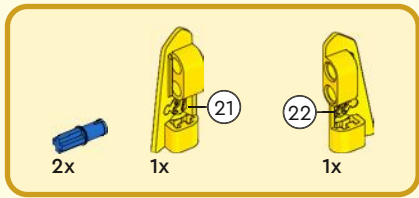

15

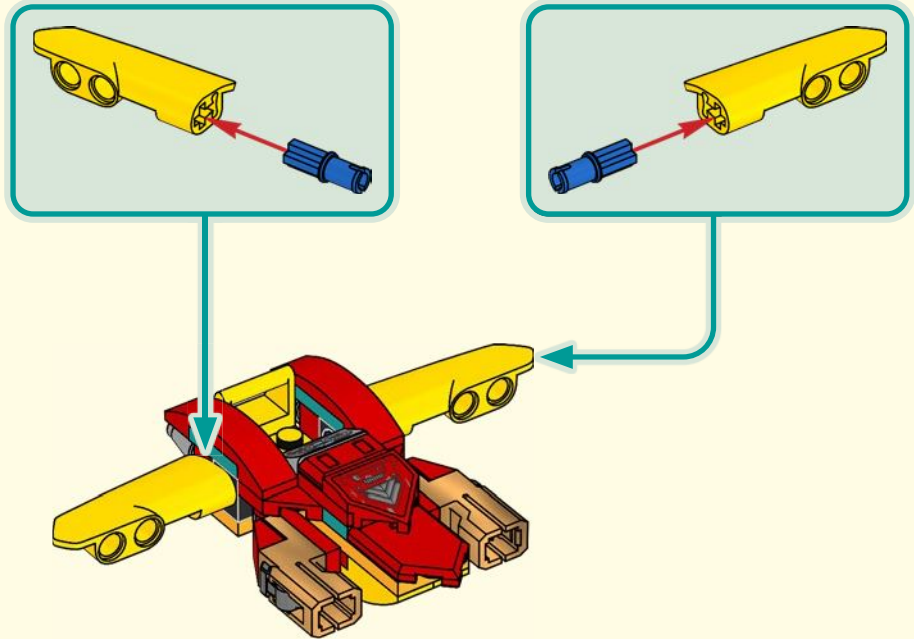

2x

16

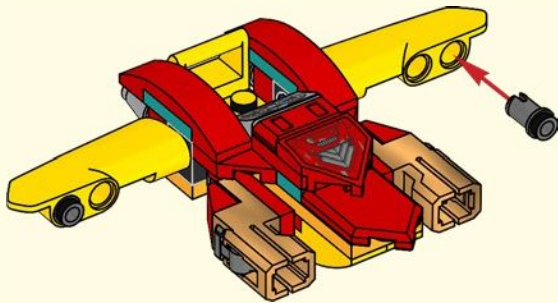

2x

17

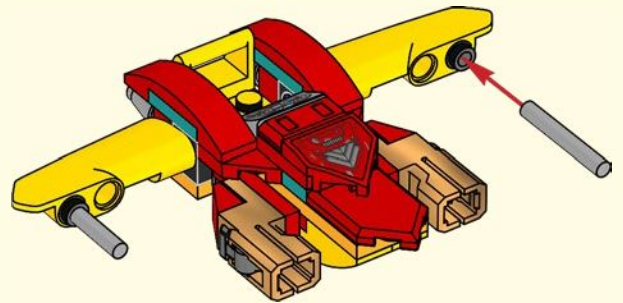



2x



2x

18

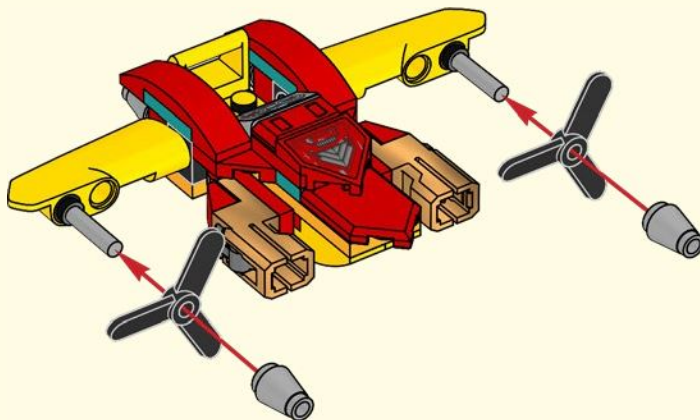



4x

19

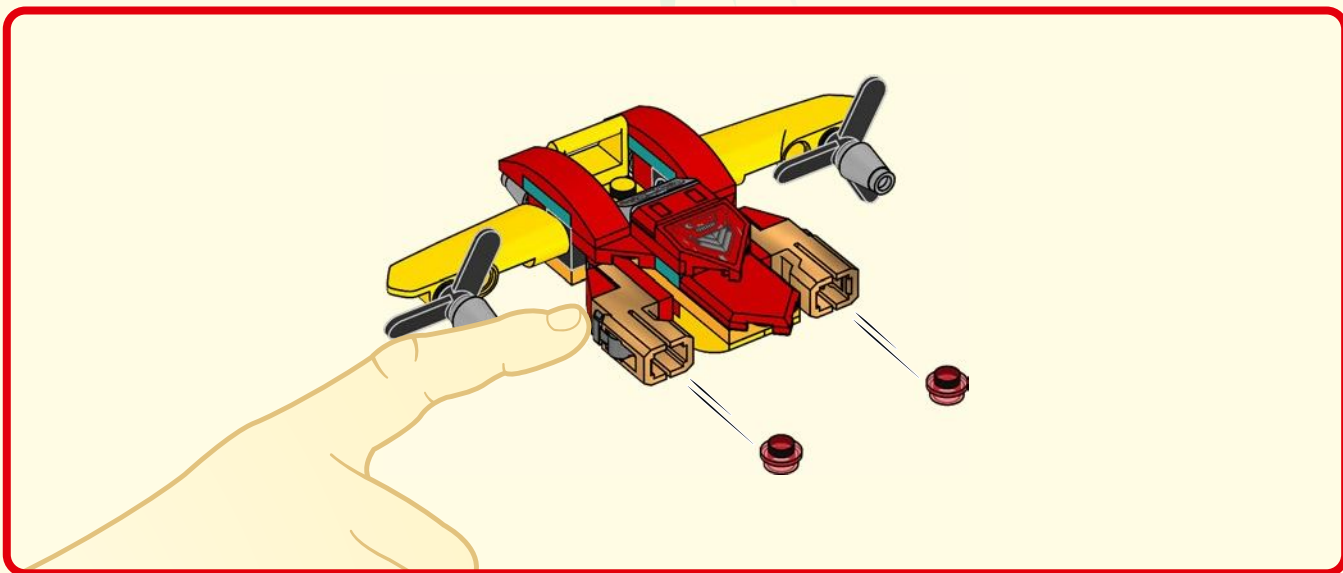
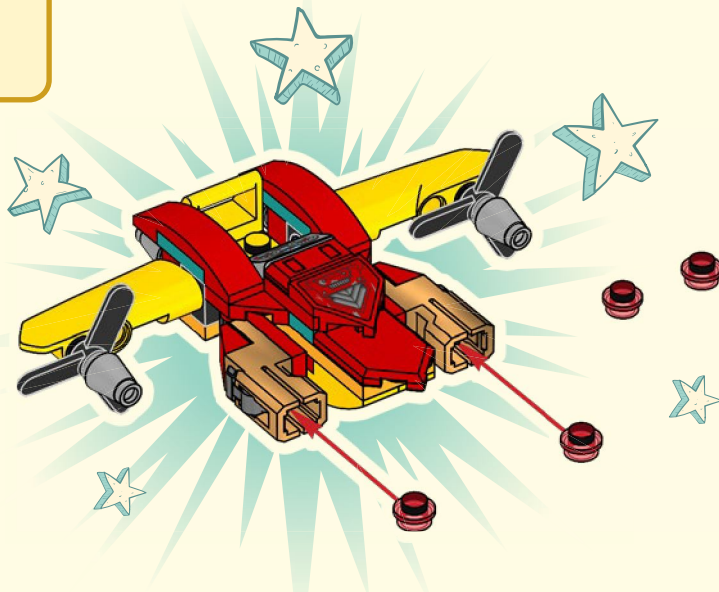



1

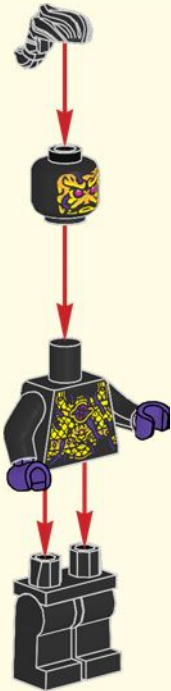

2





1



2



3





4

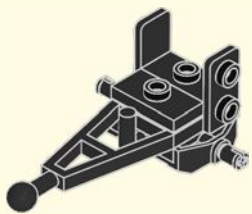

5

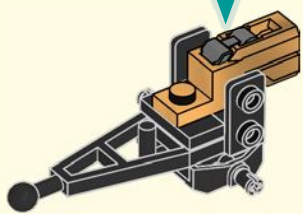
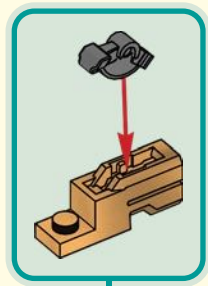





6

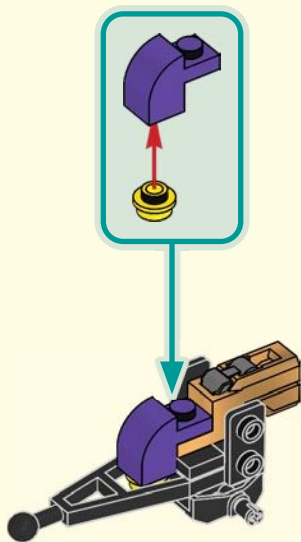

7

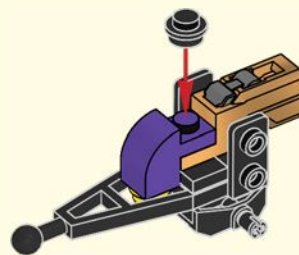

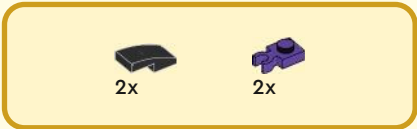

8

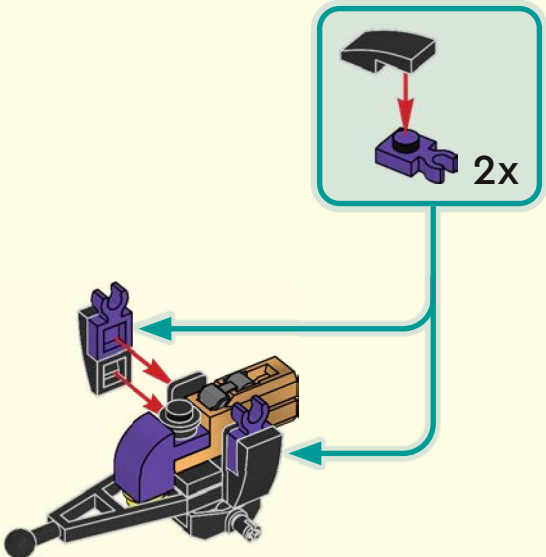

9

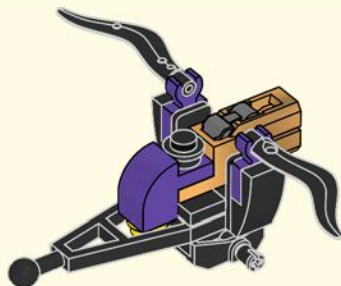



2x

10



2x

11

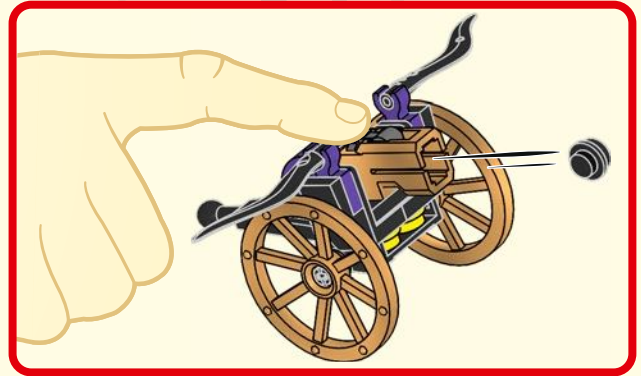

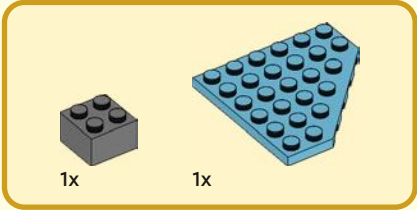

1

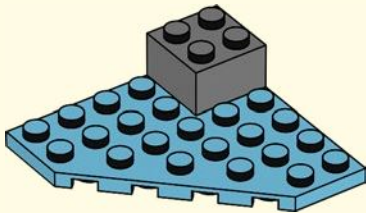

2

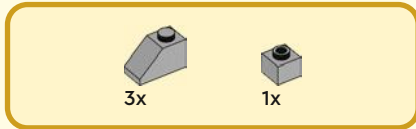
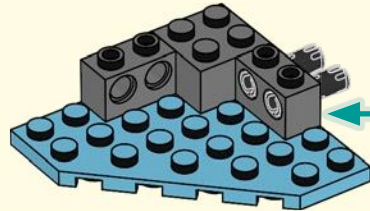
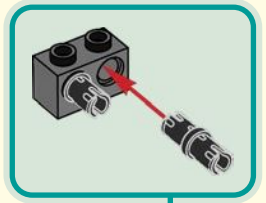

3

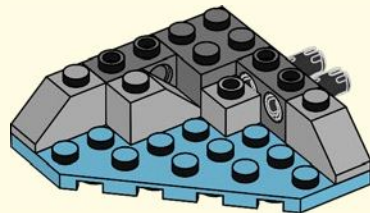



4

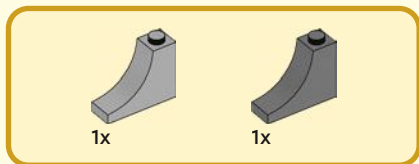
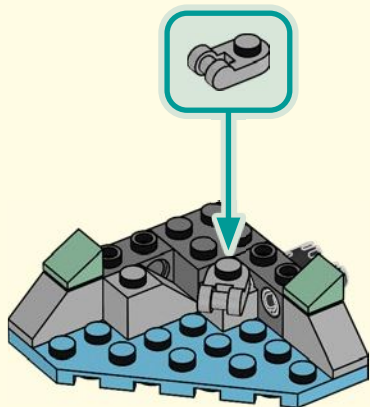

5

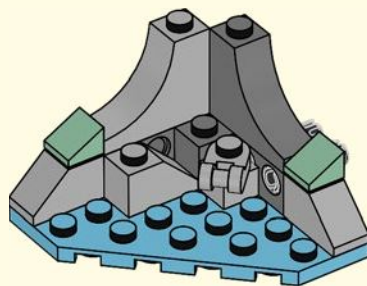

6

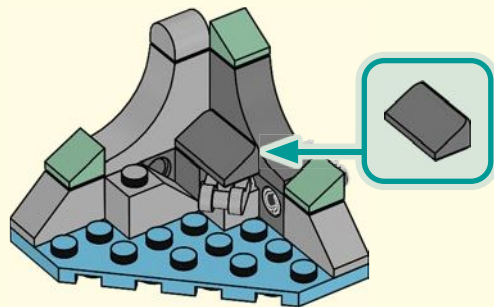



2x



2x

7

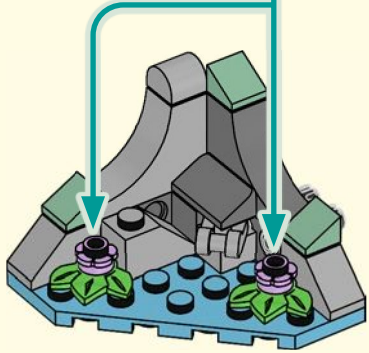

1x



1x

8





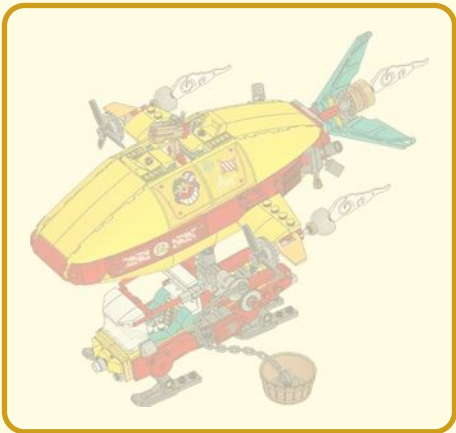

1x

1

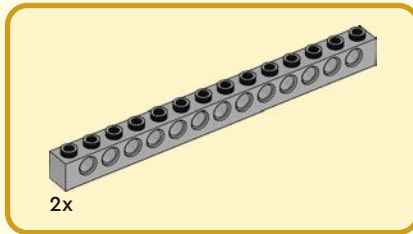

2x

2

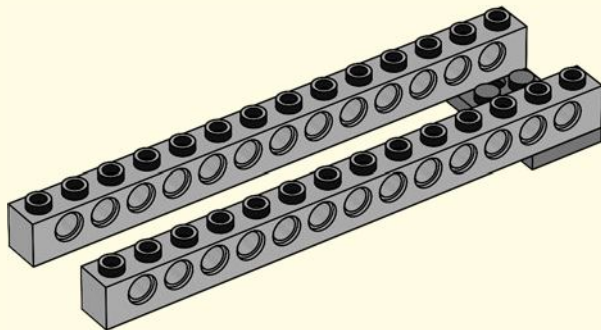





2x



1x

3

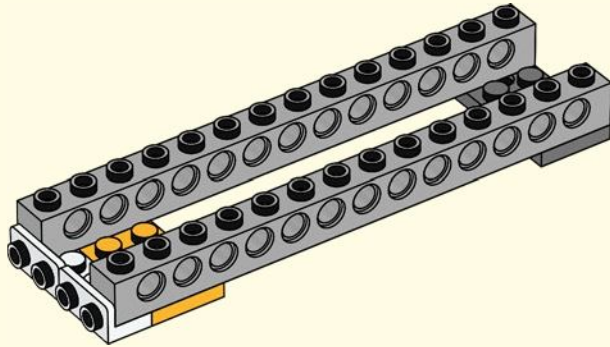

2x

4

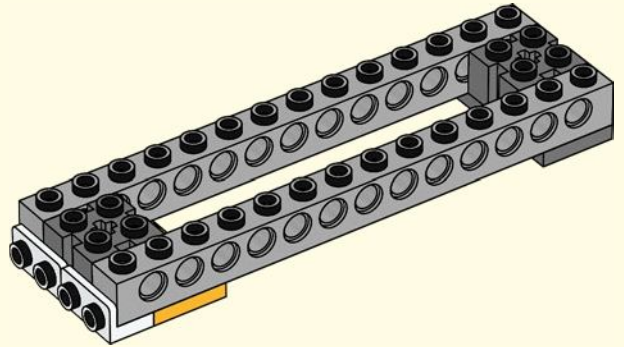



5

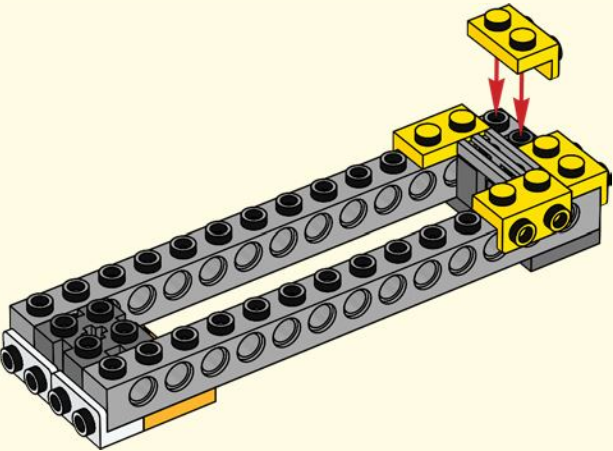

6

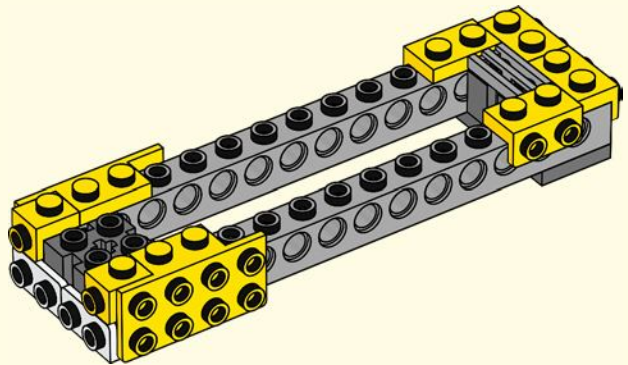



7

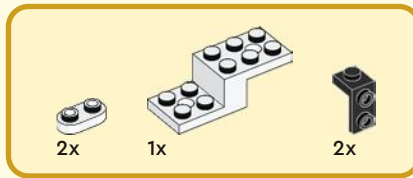
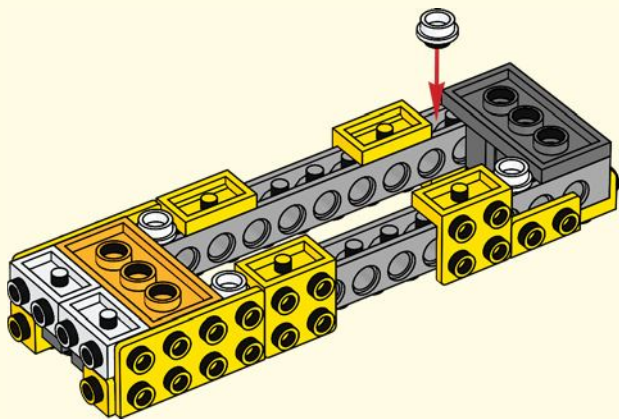

8

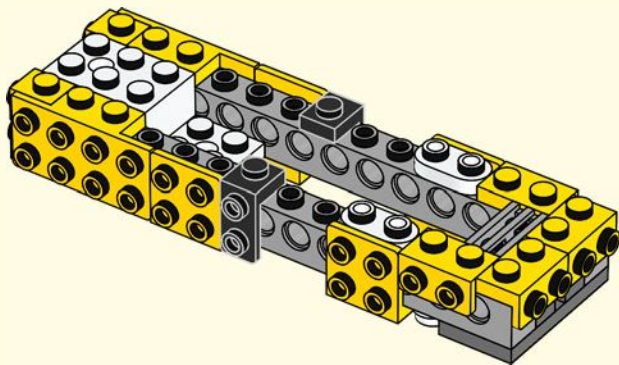



2x



2x

9

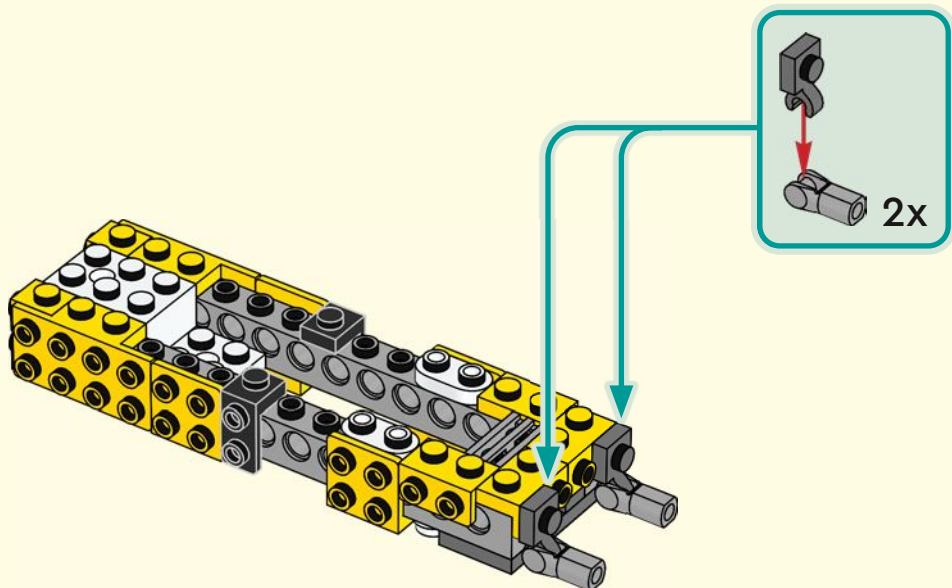



2x

10

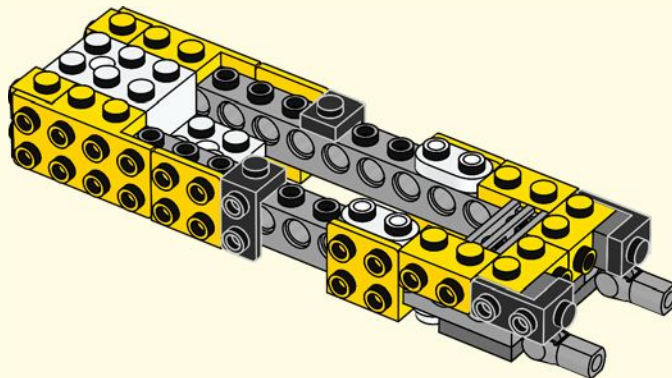

2x

11

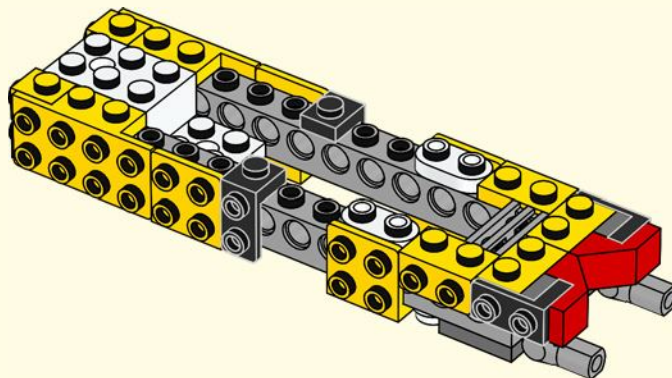

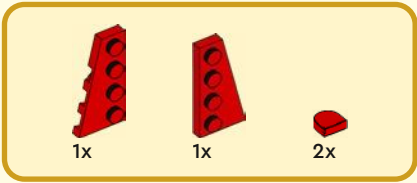

12

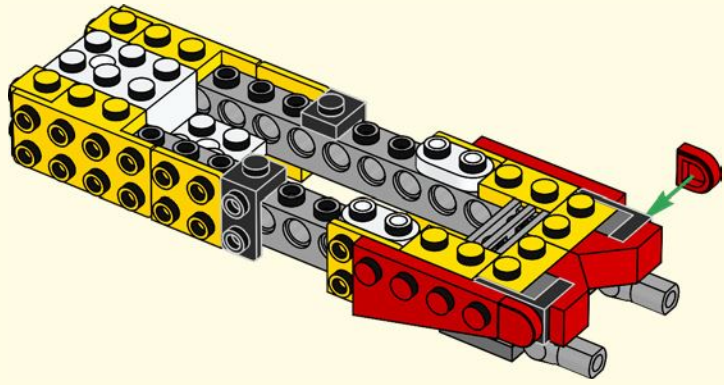



4x

13

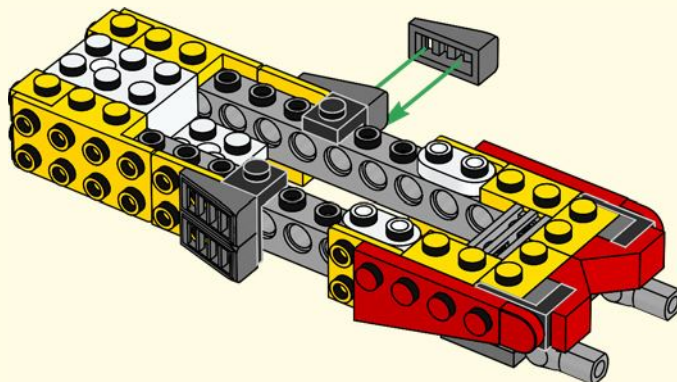



2x



2x

14

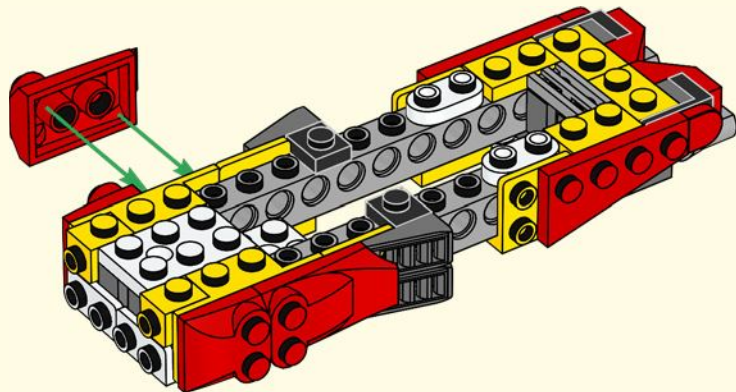





2x

15

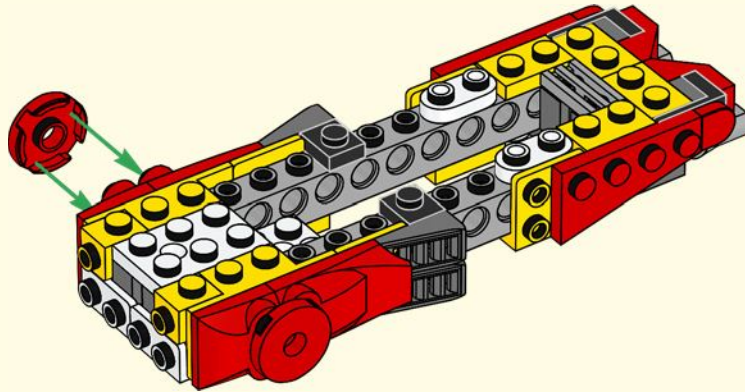

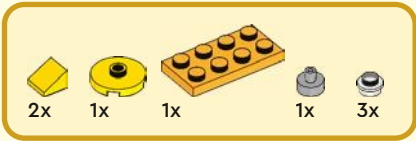

16

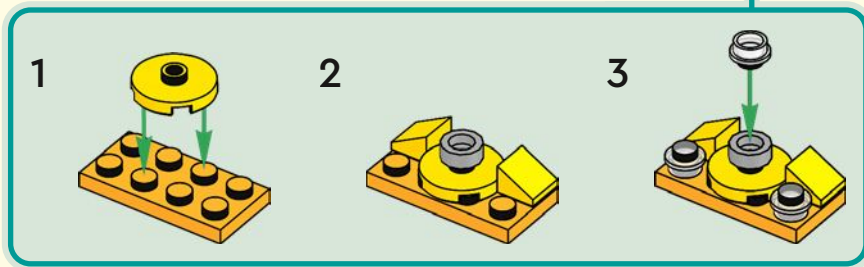
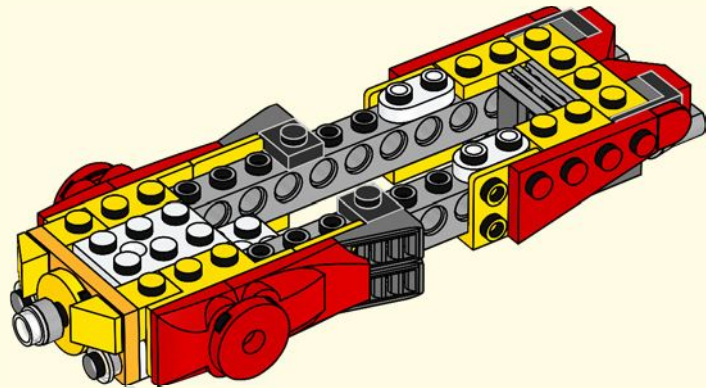



17

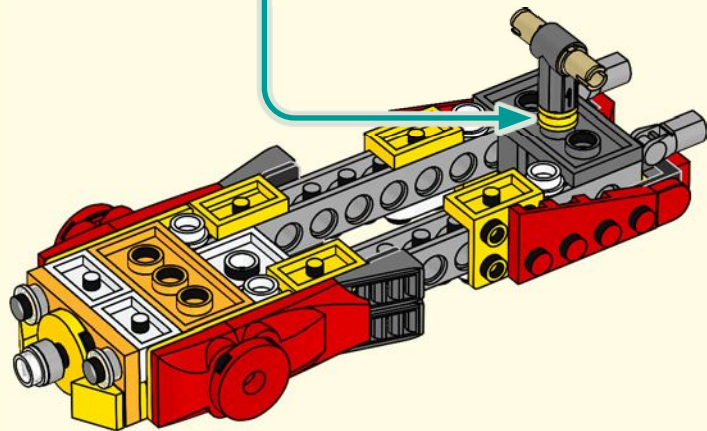
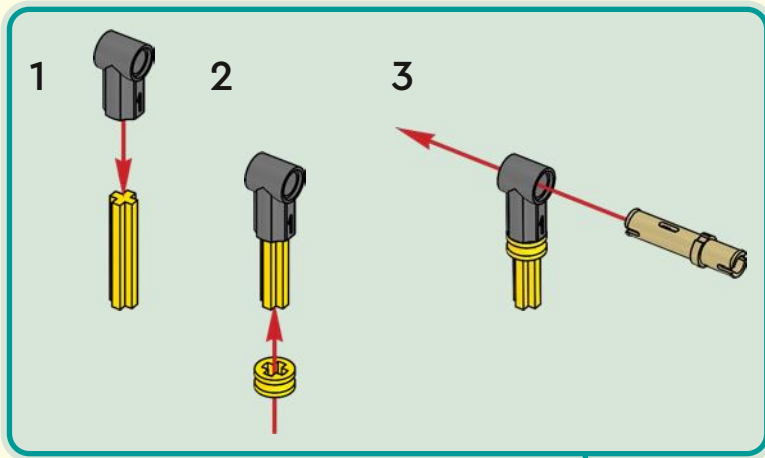
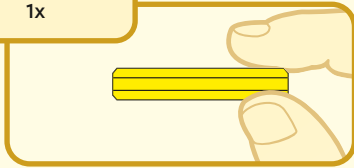

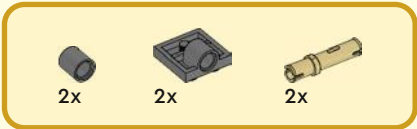

18

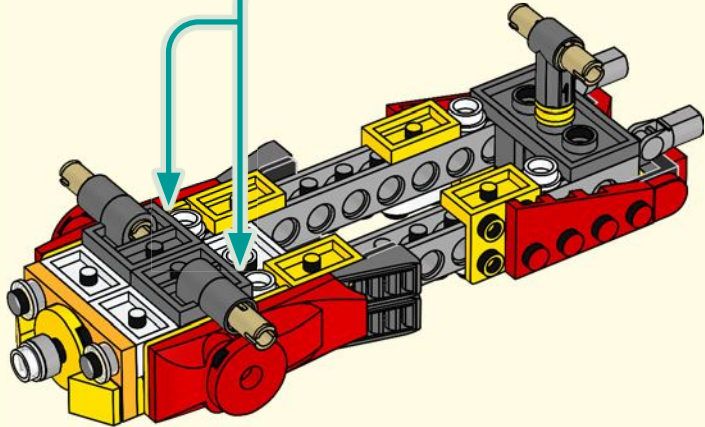
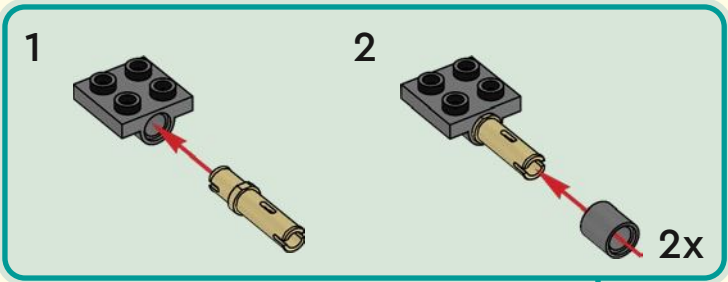

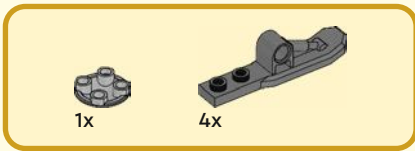

19

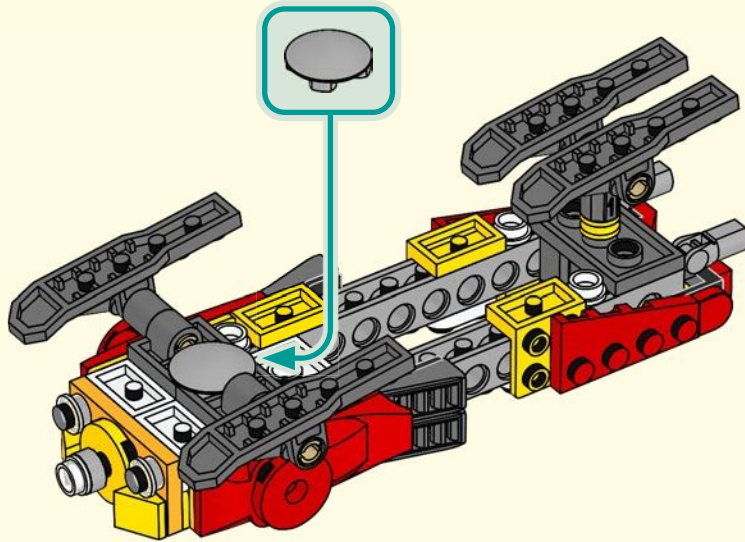



2x



2x

20

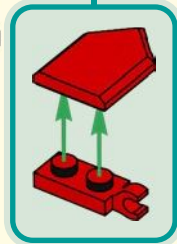
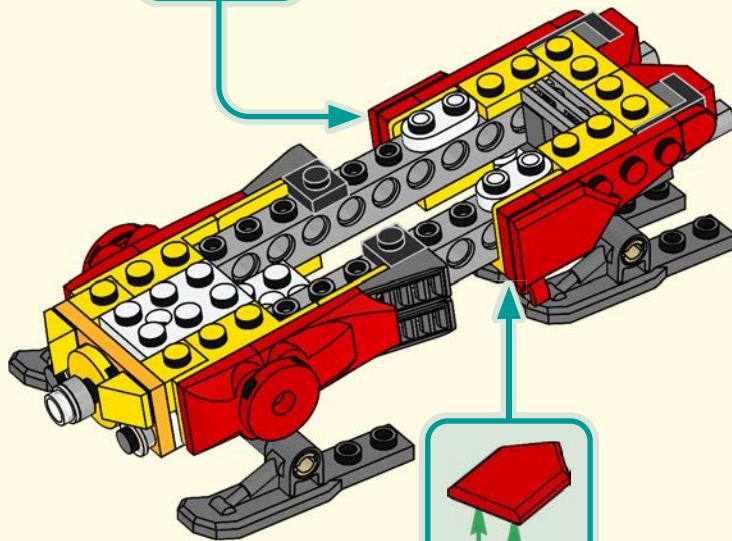
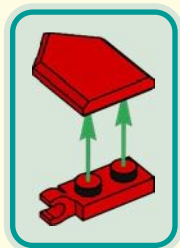

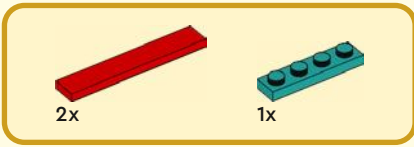

21

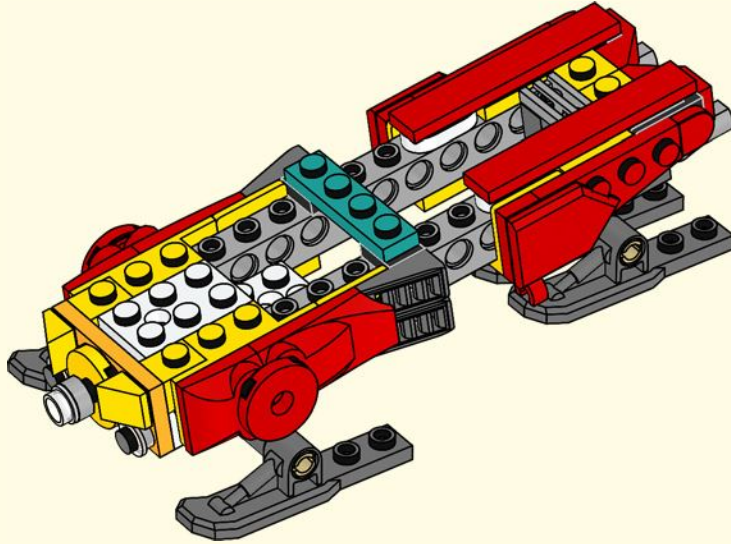



1x



2x

22

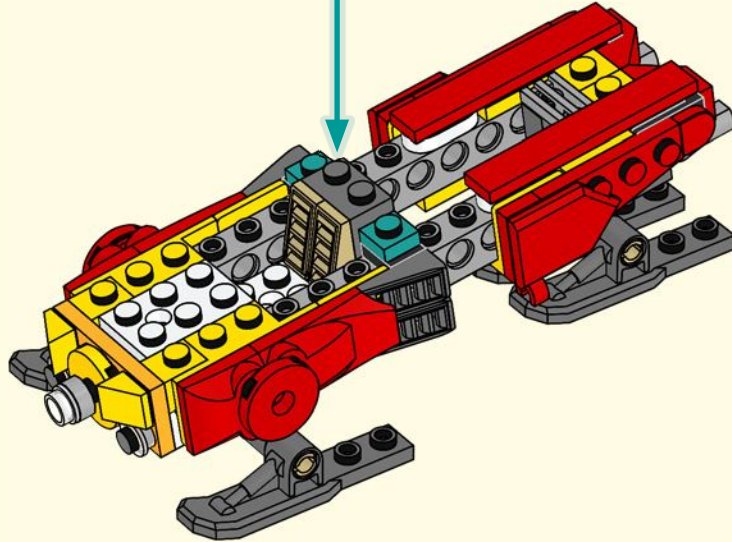
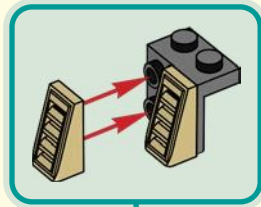





23

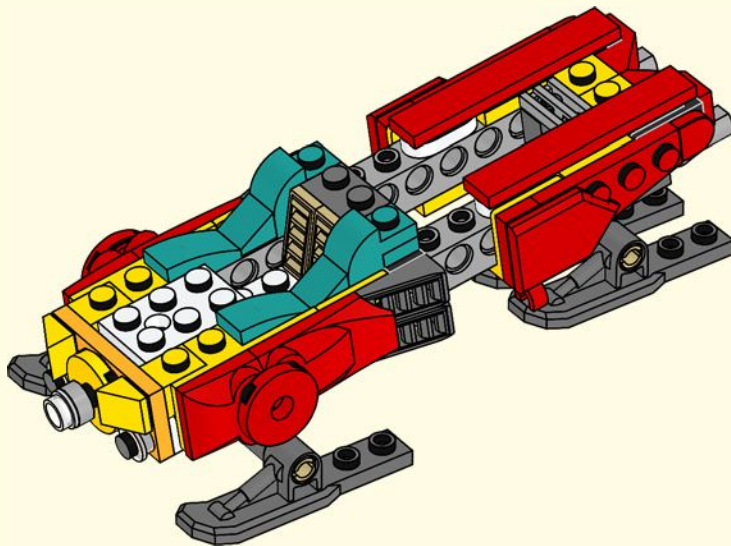

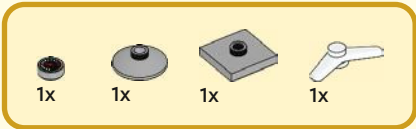

24

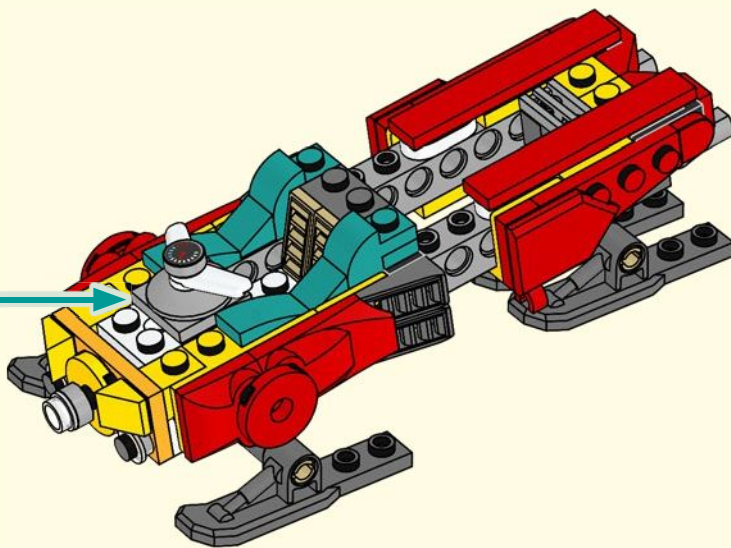
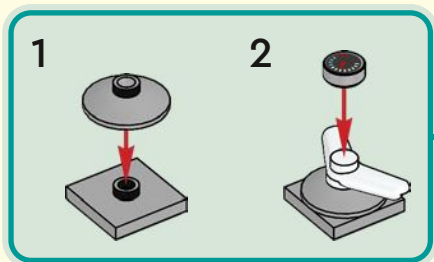



2x



2x

25

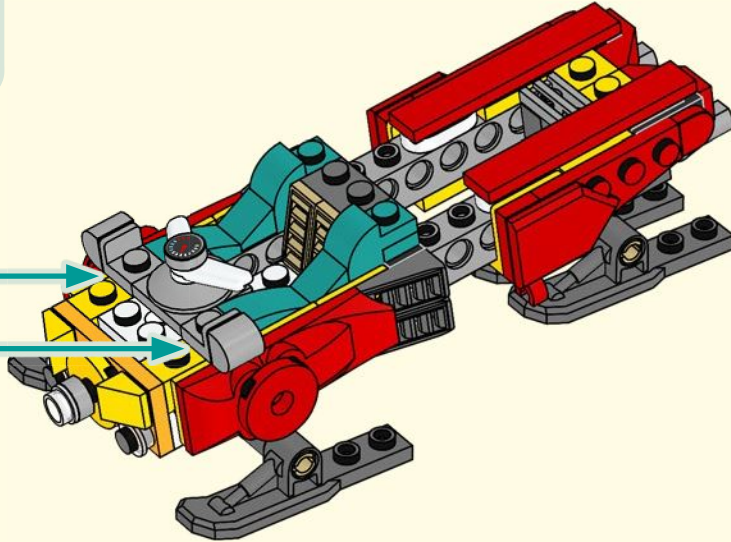
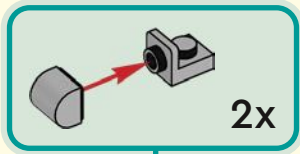



2x

26

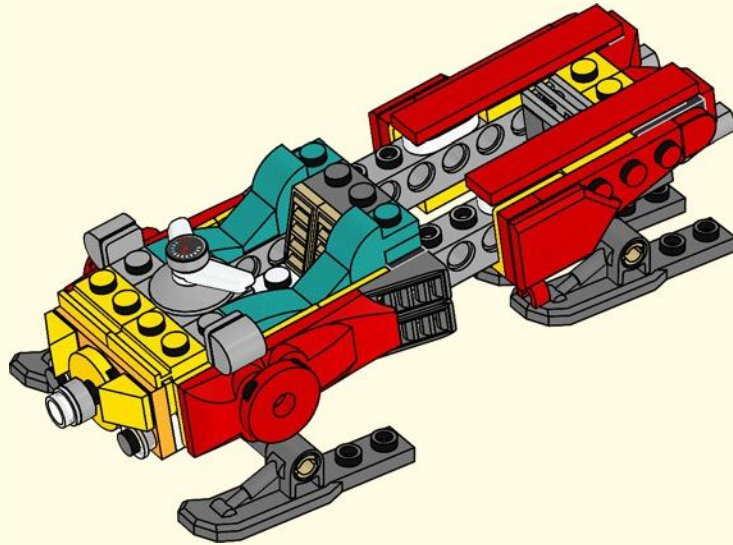

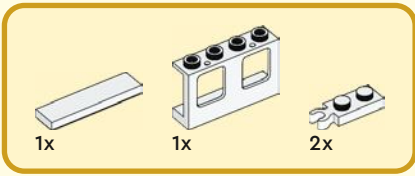

27

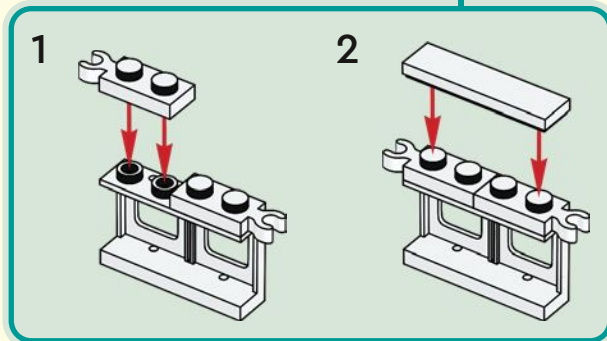
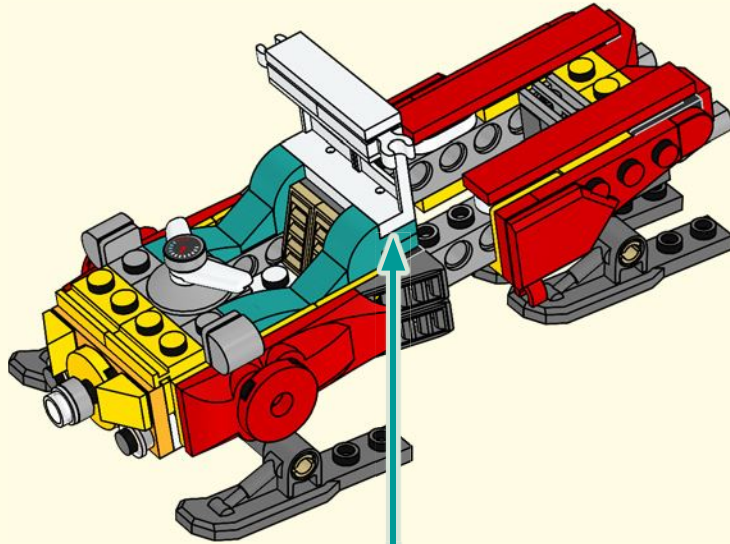

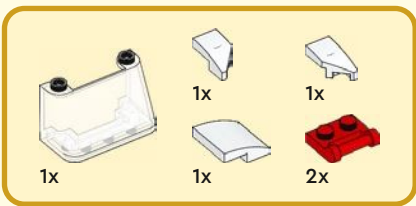

28

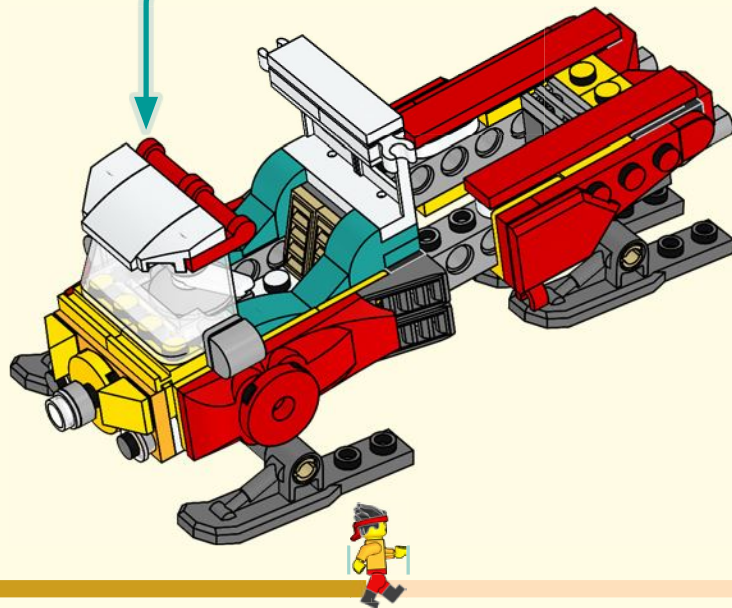
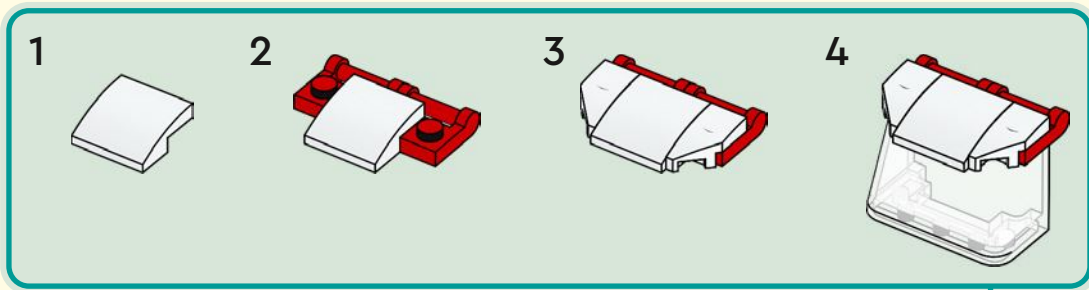



29

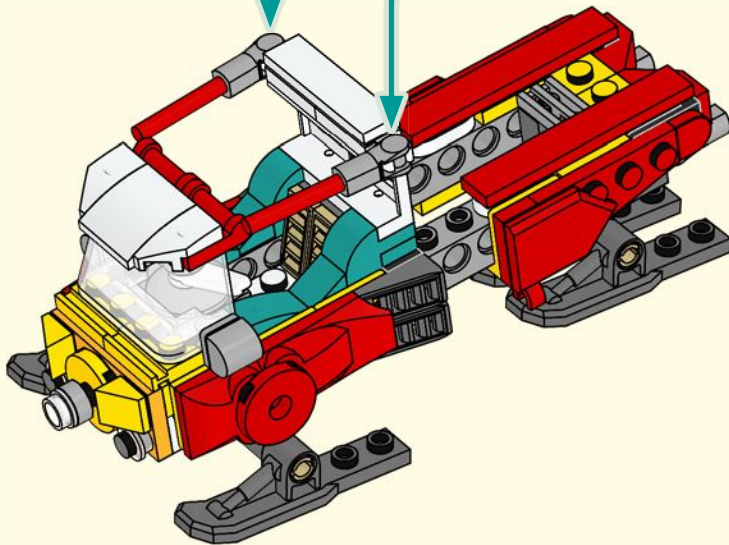
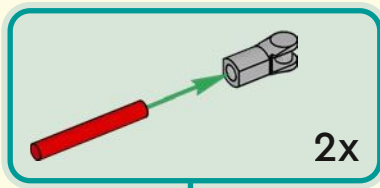

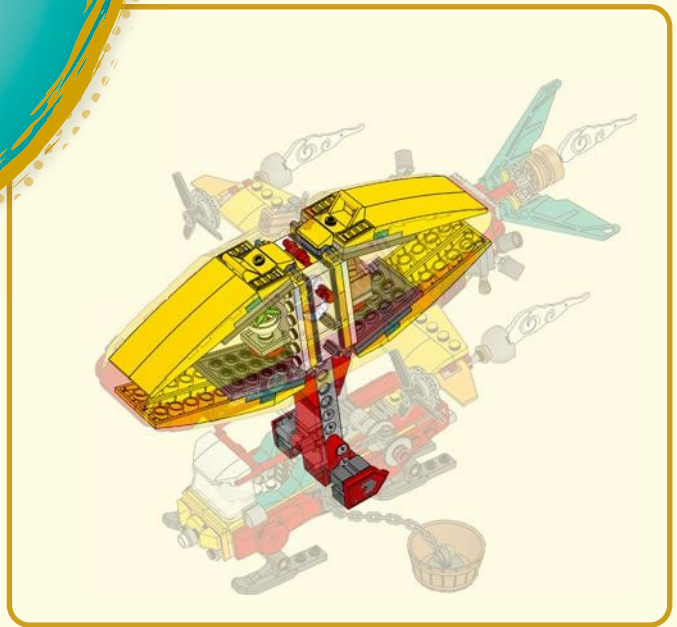



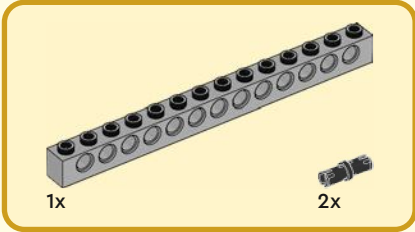
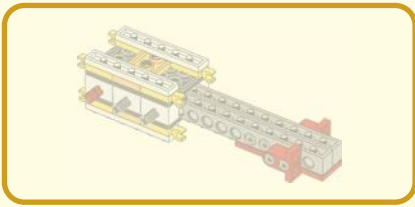

30

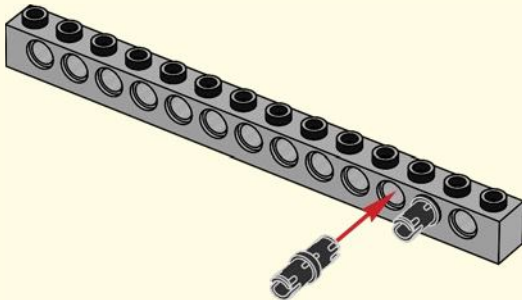

31

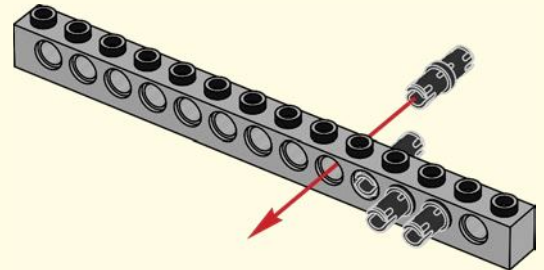

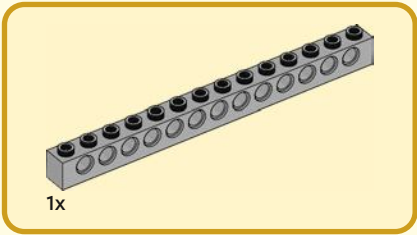

32

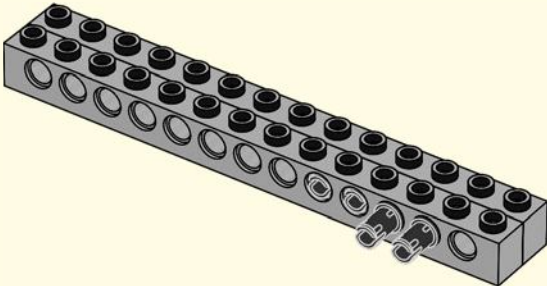

33

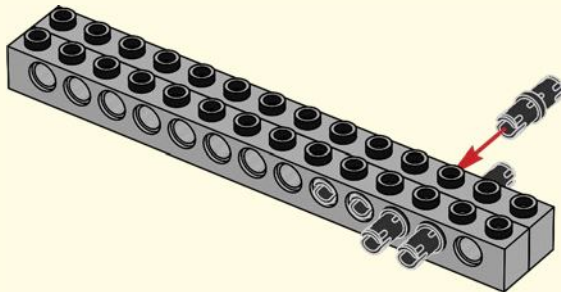

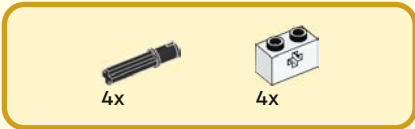

34

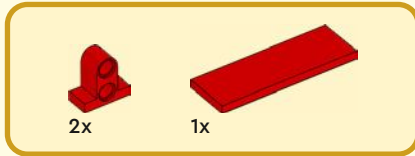
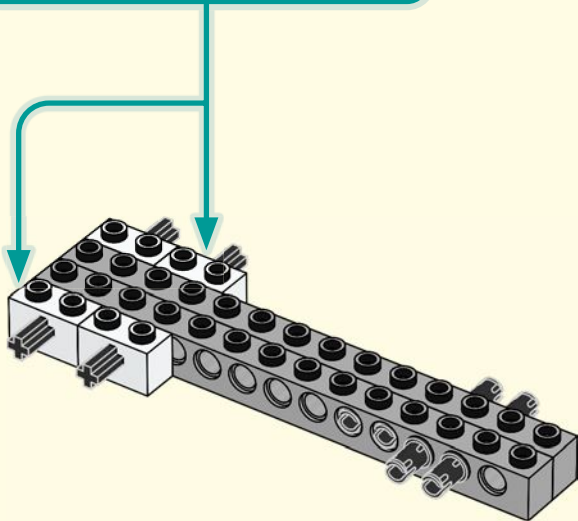
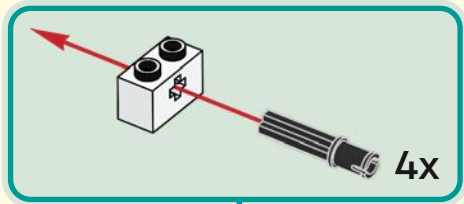

35

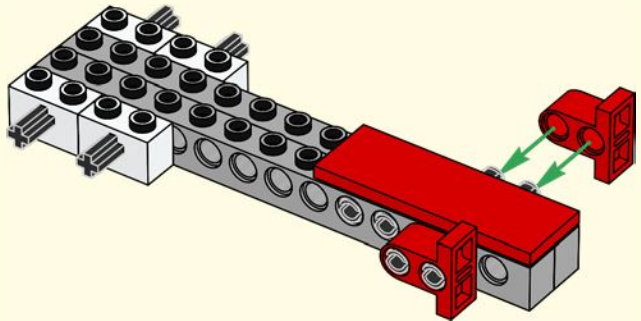

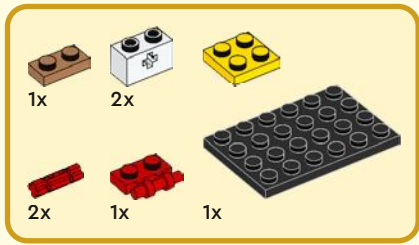

36

1



2

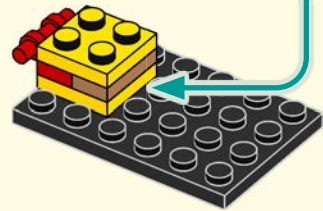

3

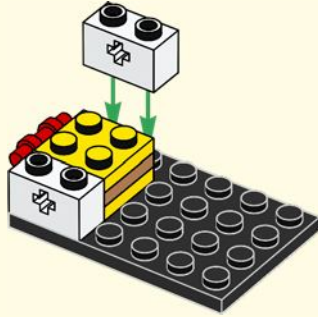

4

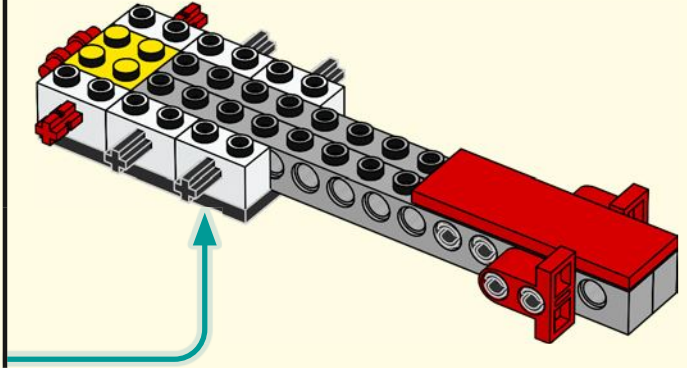
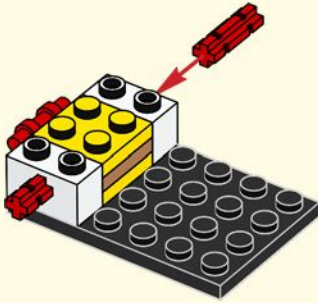



1x

37

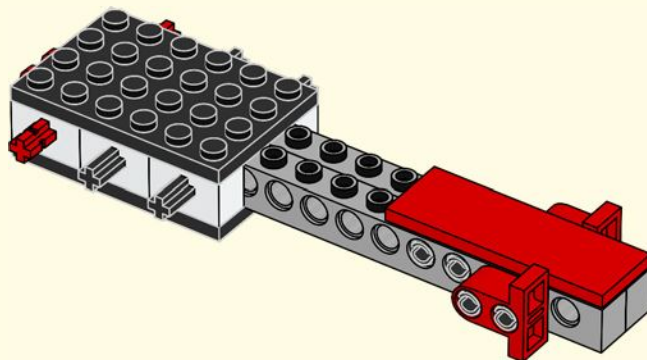



38

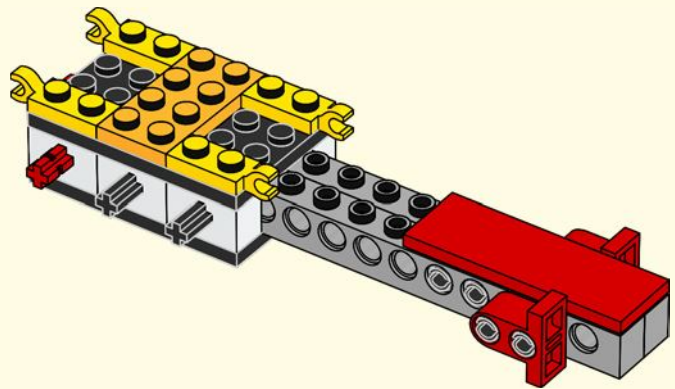



2x

39

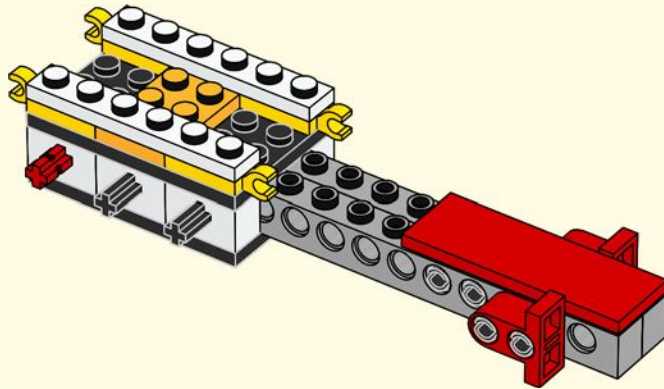





40

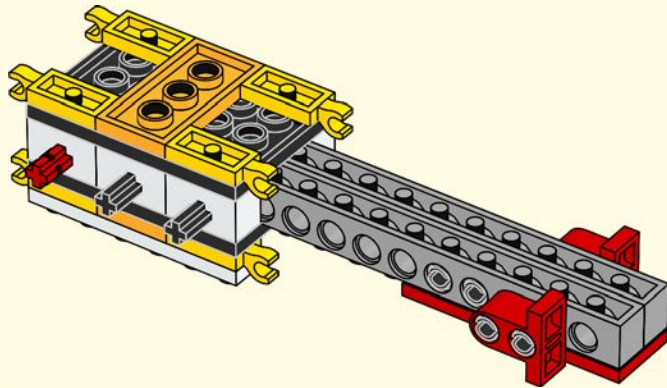



2x

41

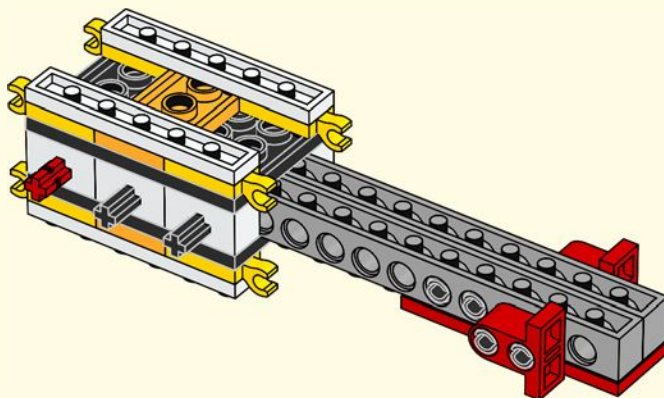

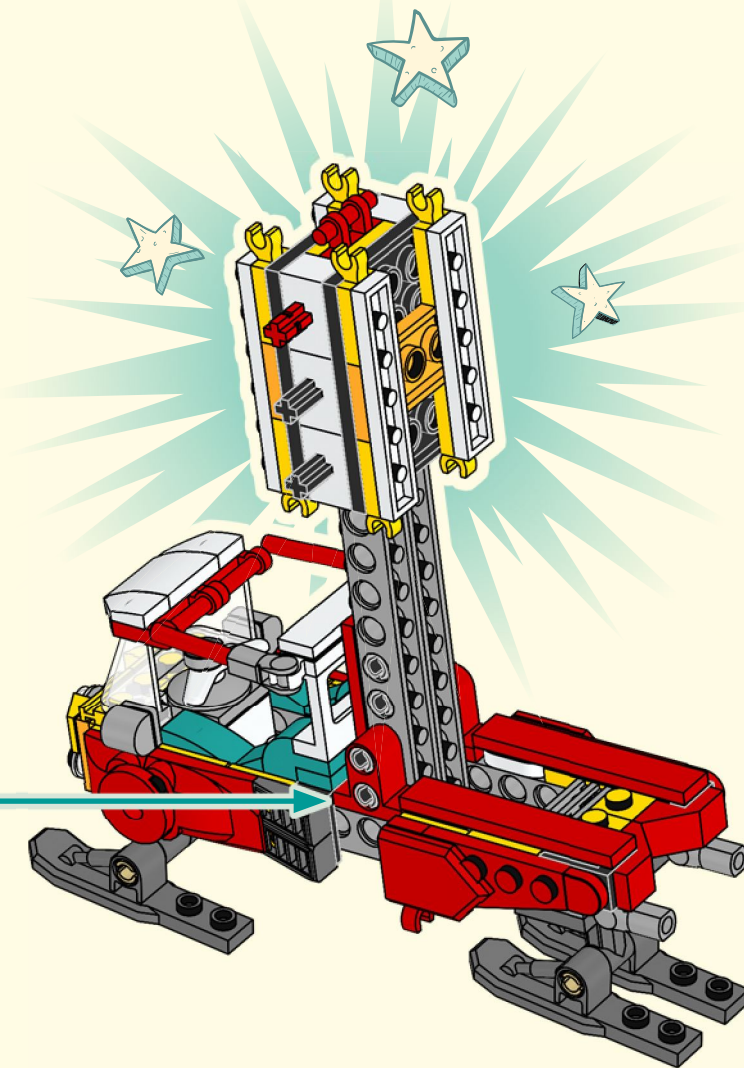

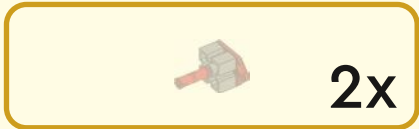

# 43

1

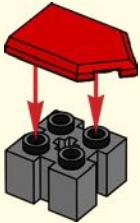

2



3

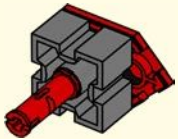

2x



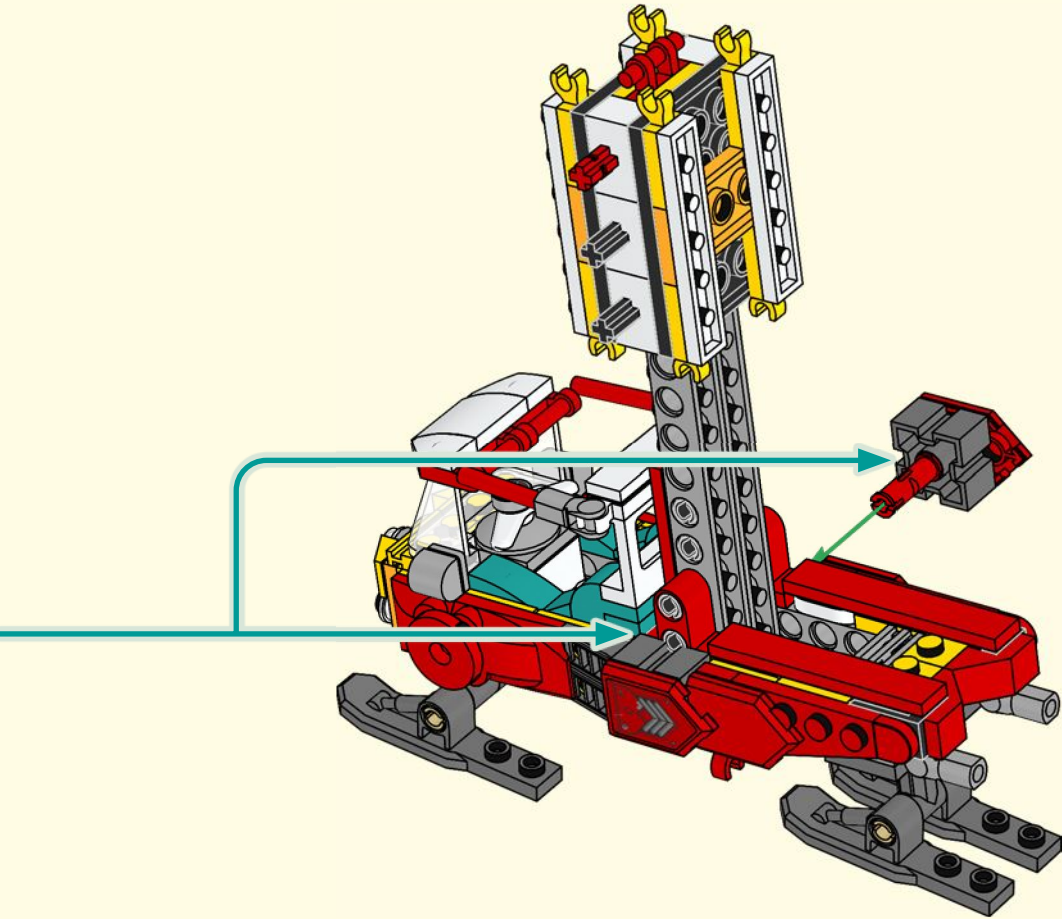



1x



1x

44

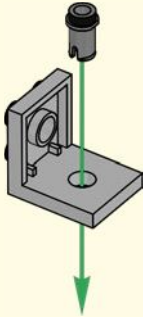

1x

45

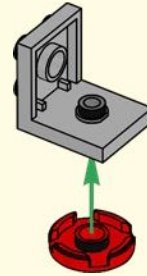



46

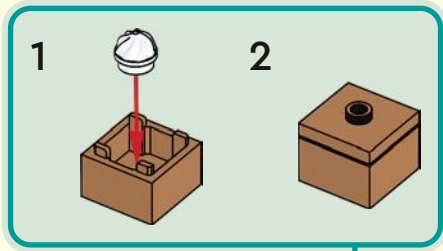

47

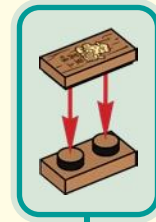

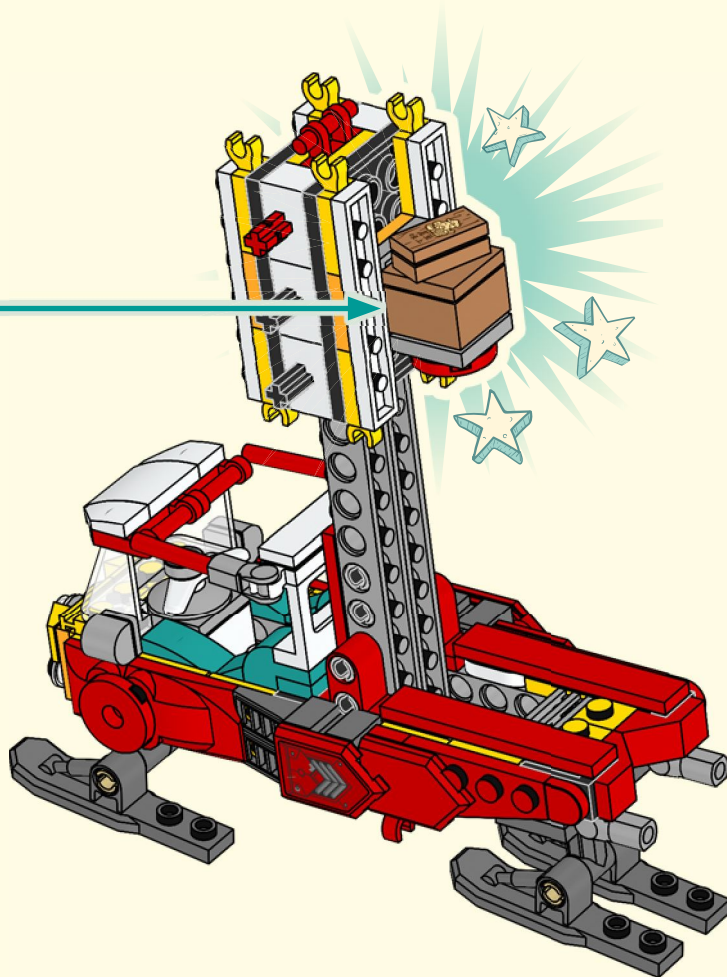



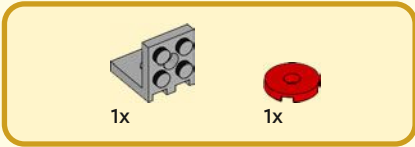

49

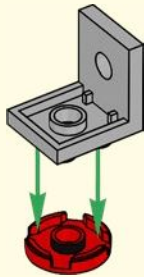

50

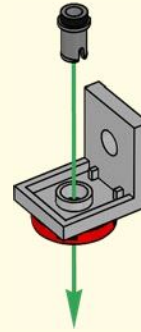

51

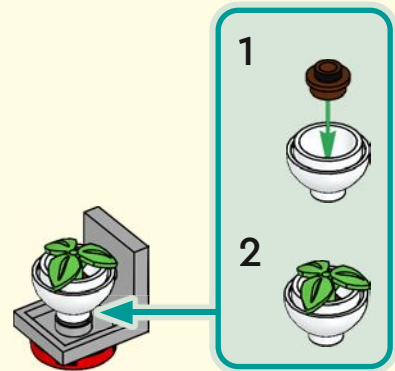

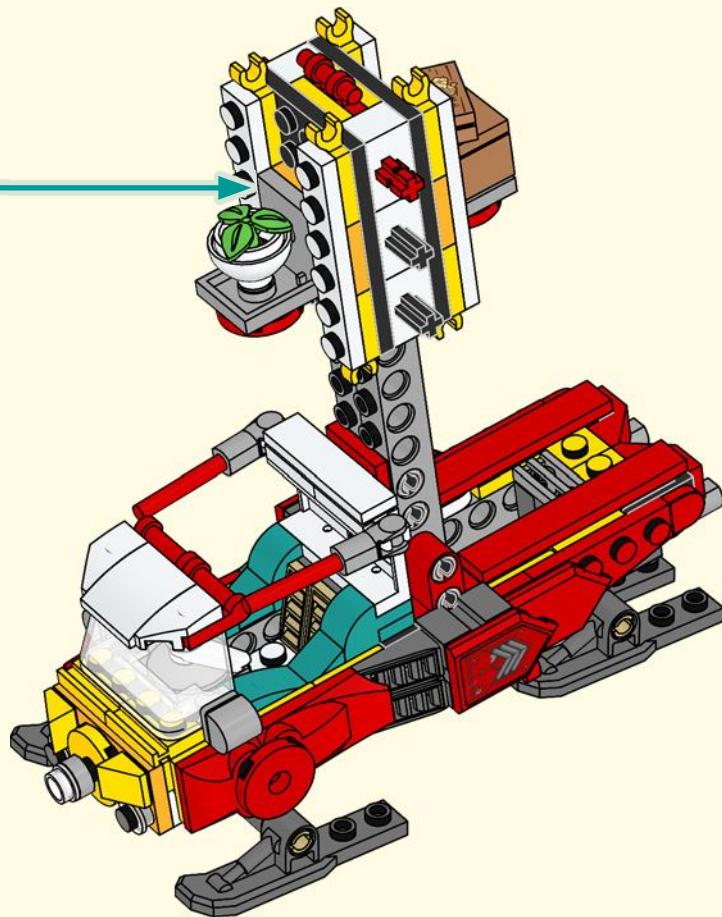

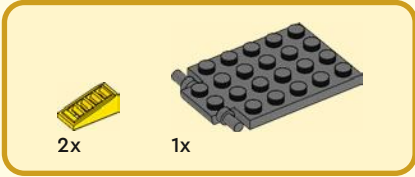
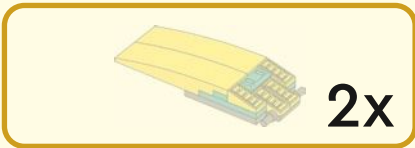

53

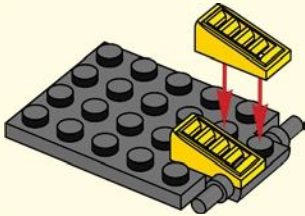

54

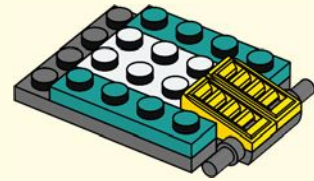

55

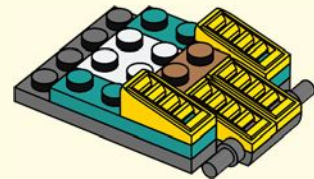

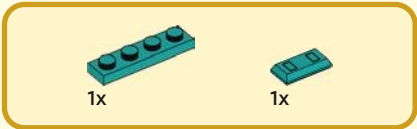

56

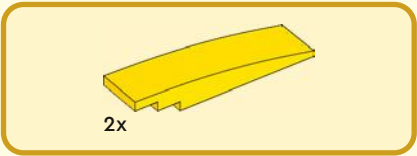
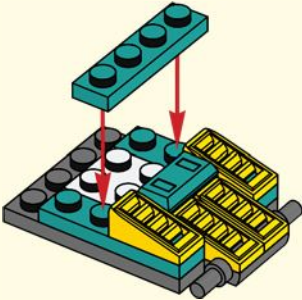

57

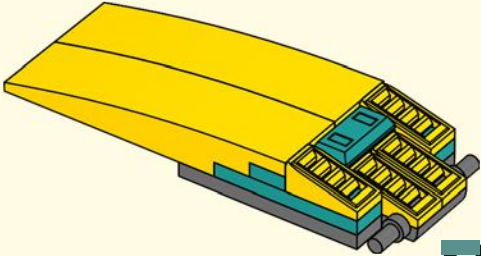

2x



58

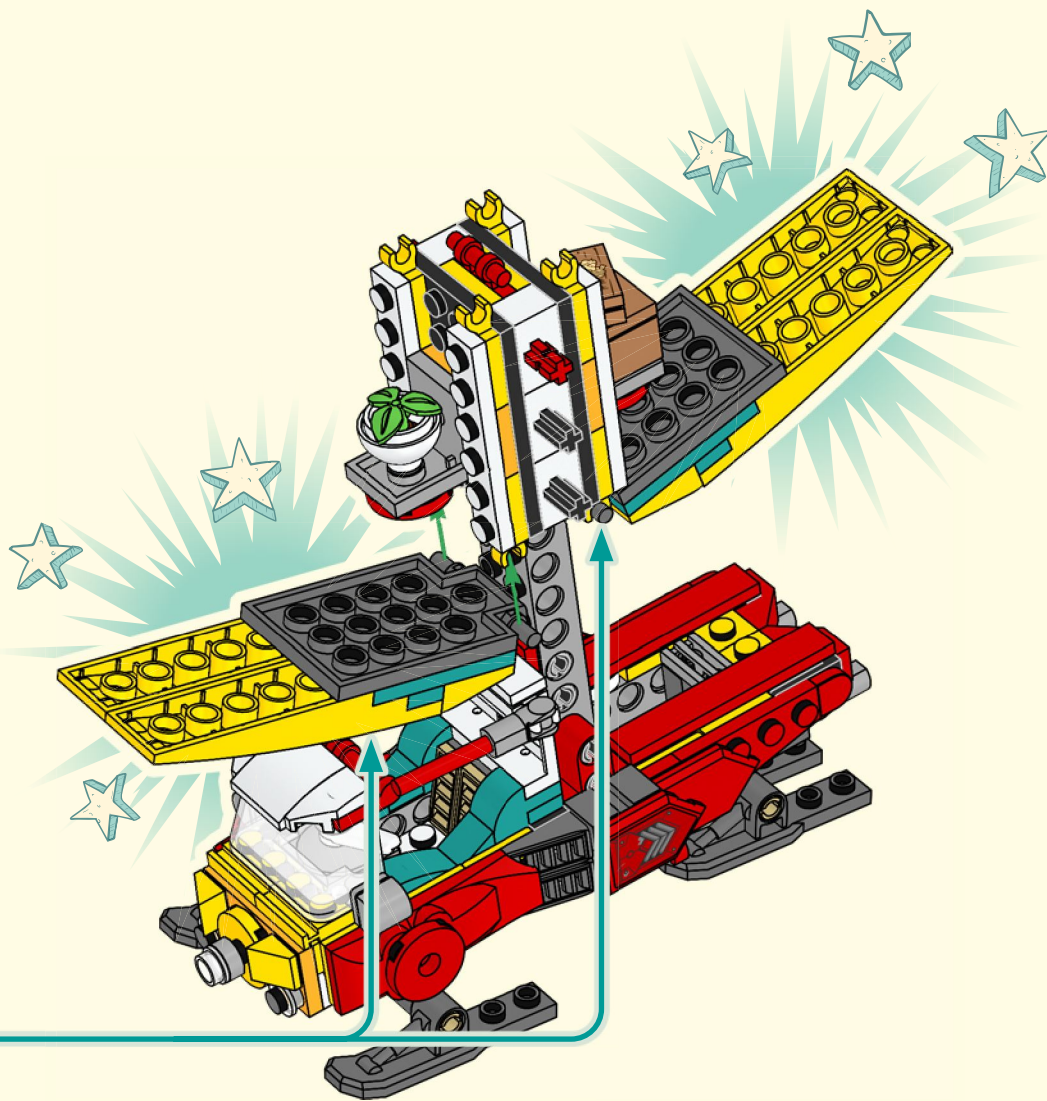

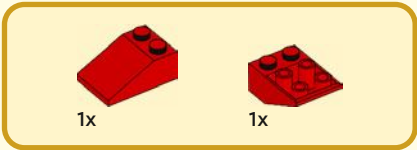

59

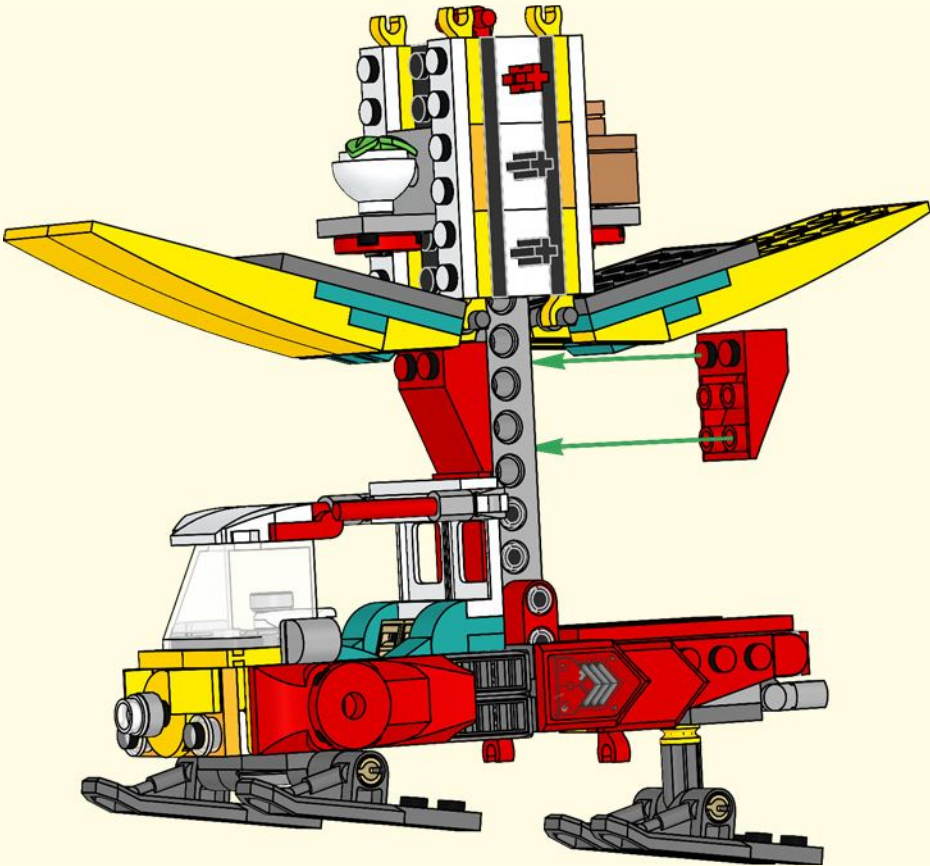

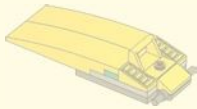

2x



1x

60

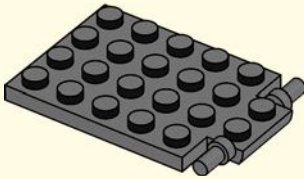

1x



1x

61



2x



1x

62

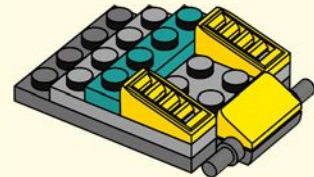

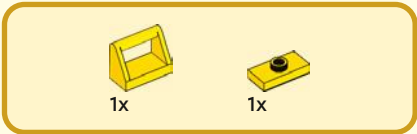

63

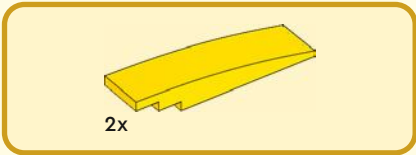
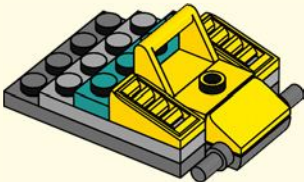

64

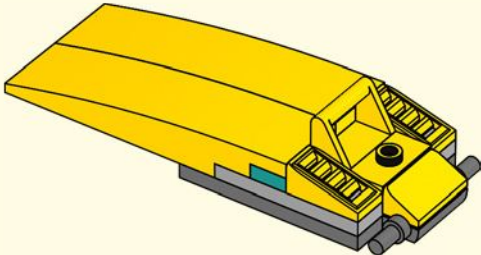

2x



65

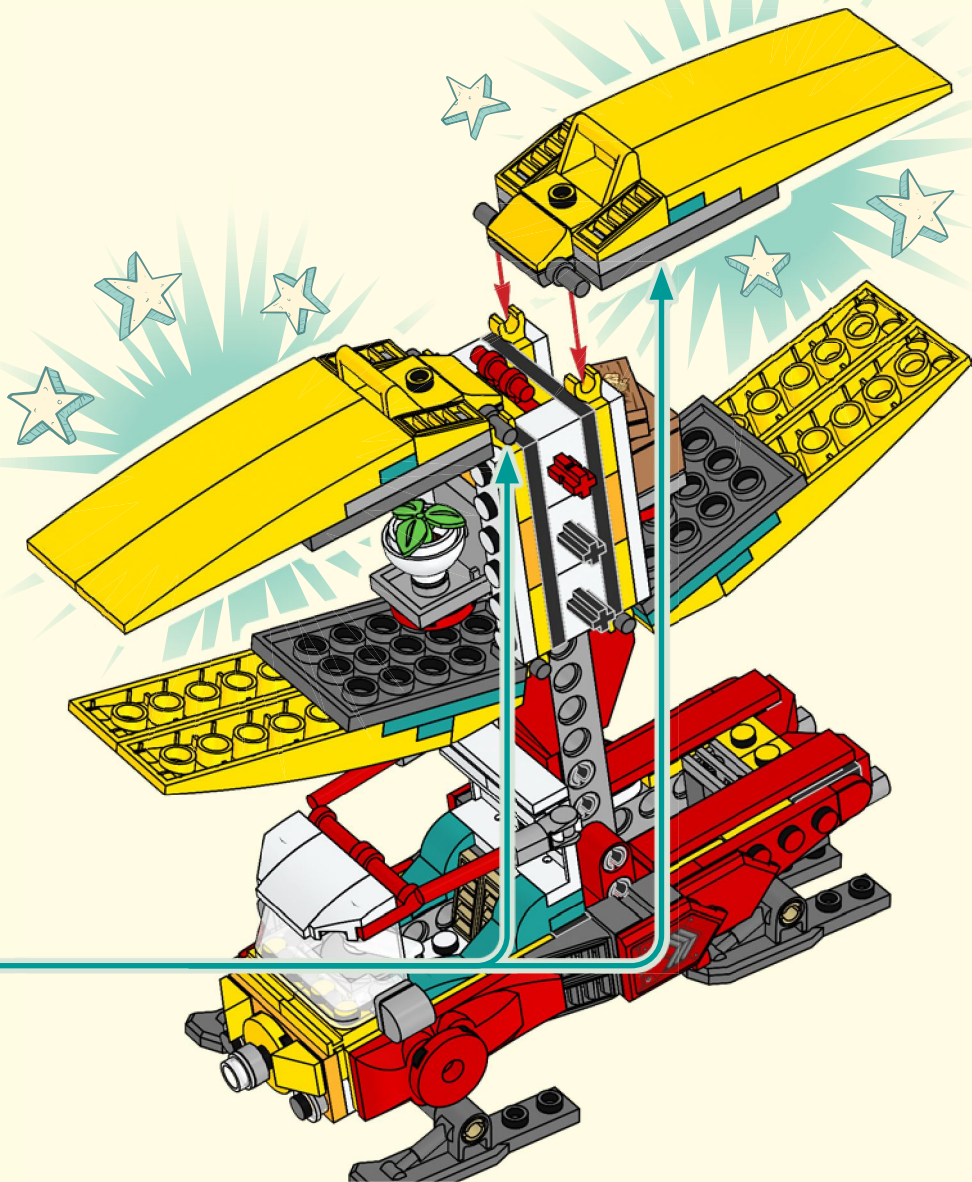

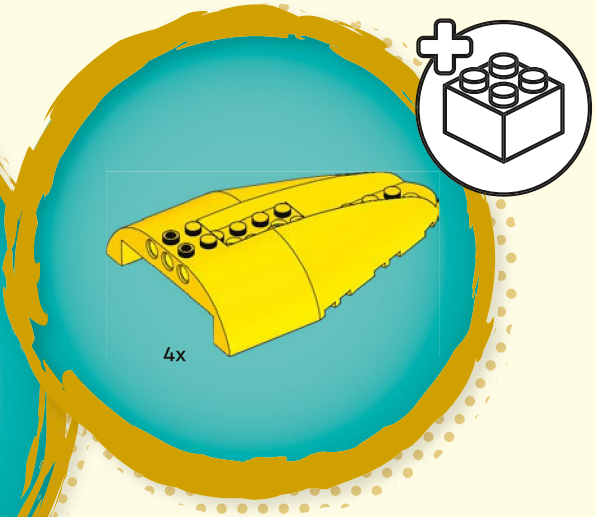

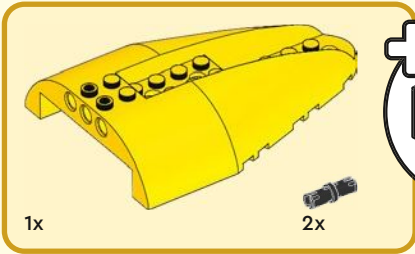

66

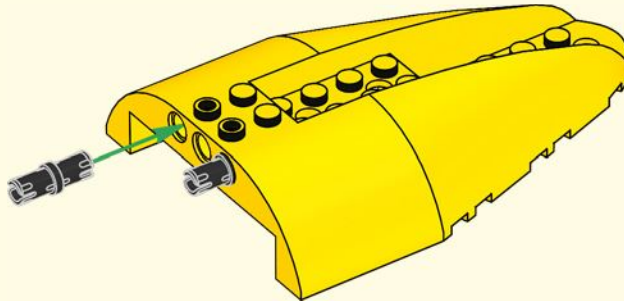

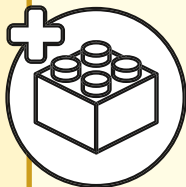
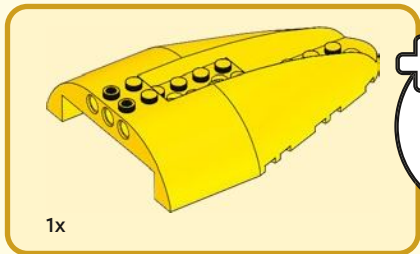

67

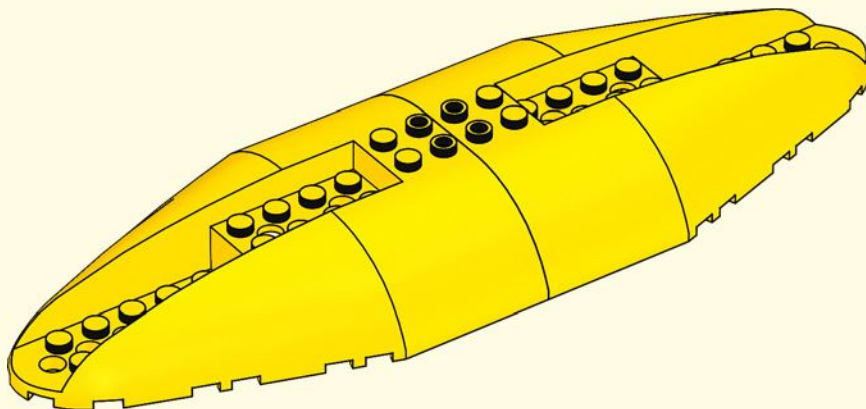



68

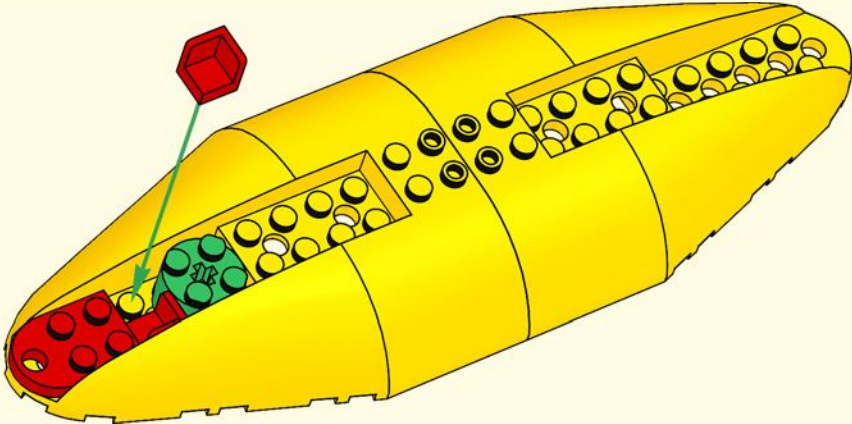

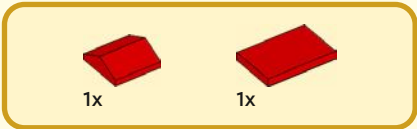

69

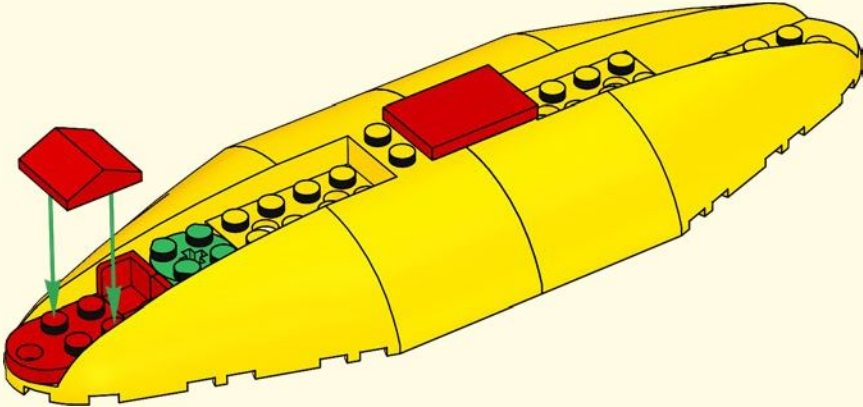

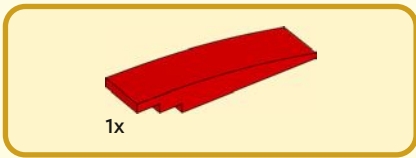

70

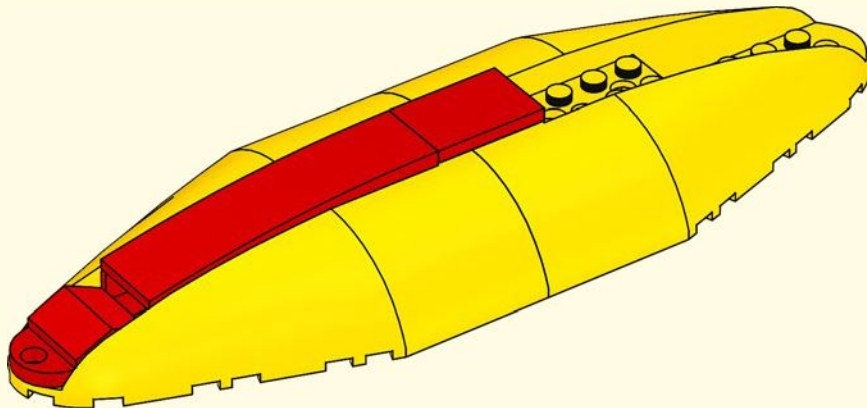



1x



2x

71

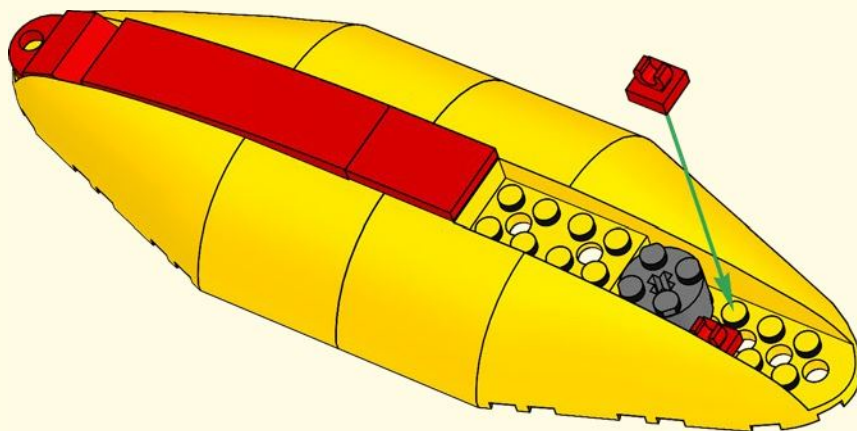



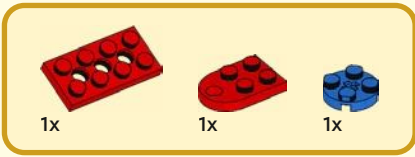

72

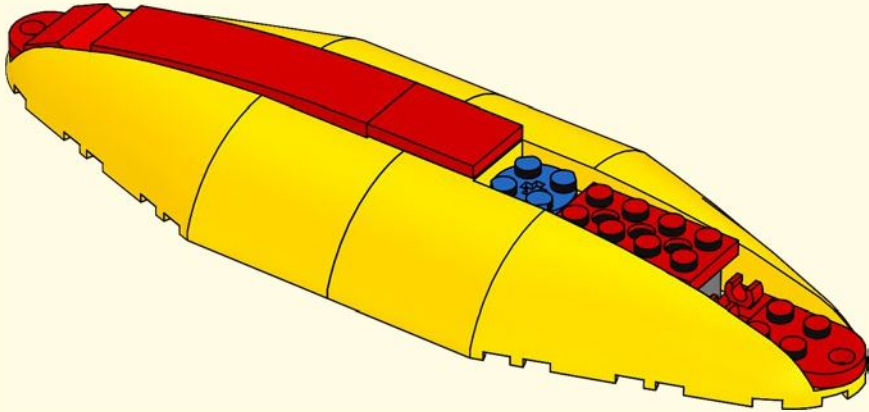

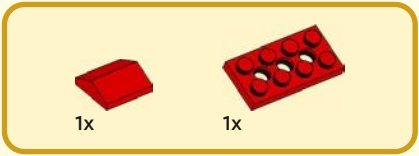

73

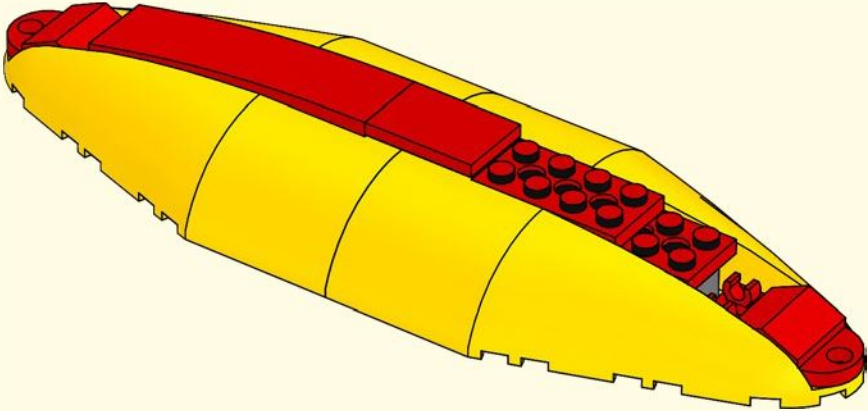



74

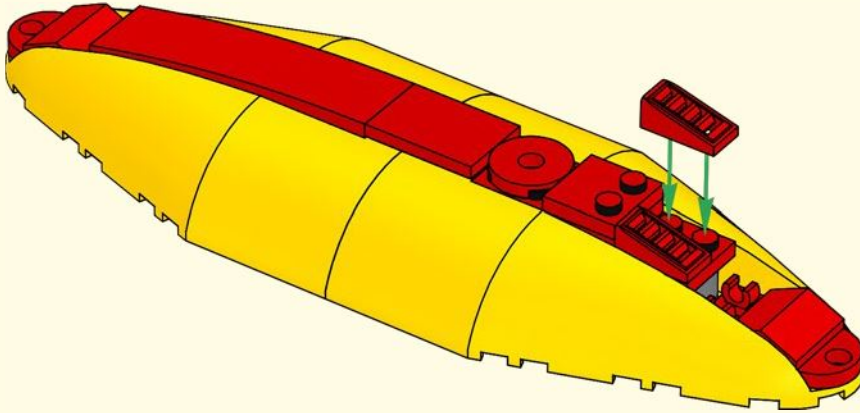

75





3x

76

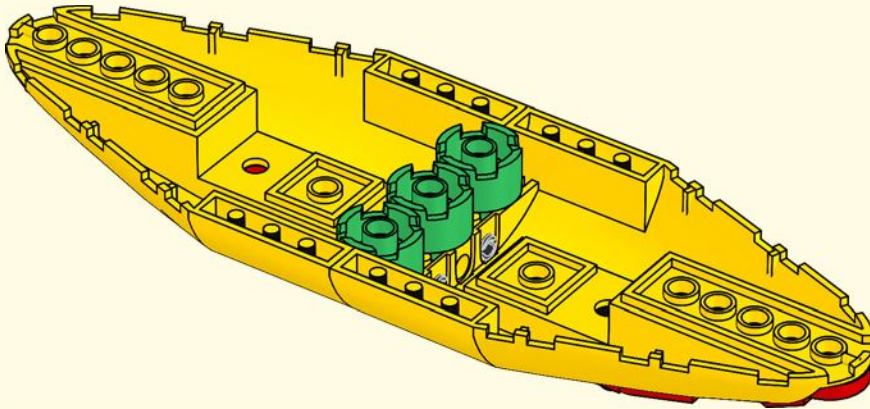



2x



2x

77

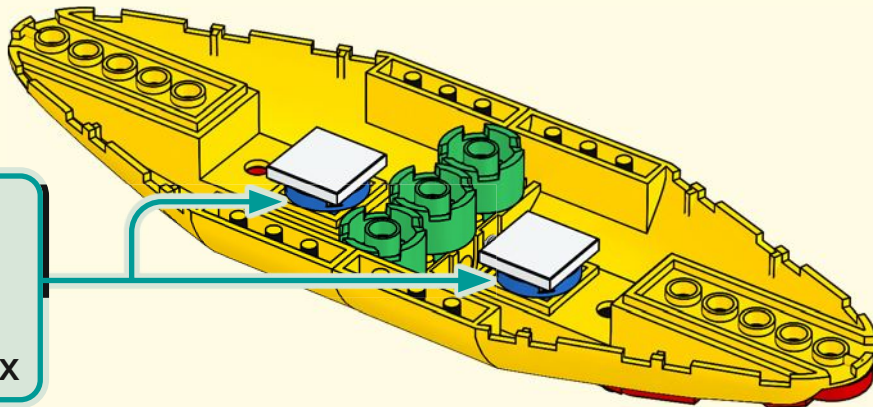
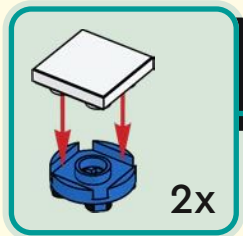

78

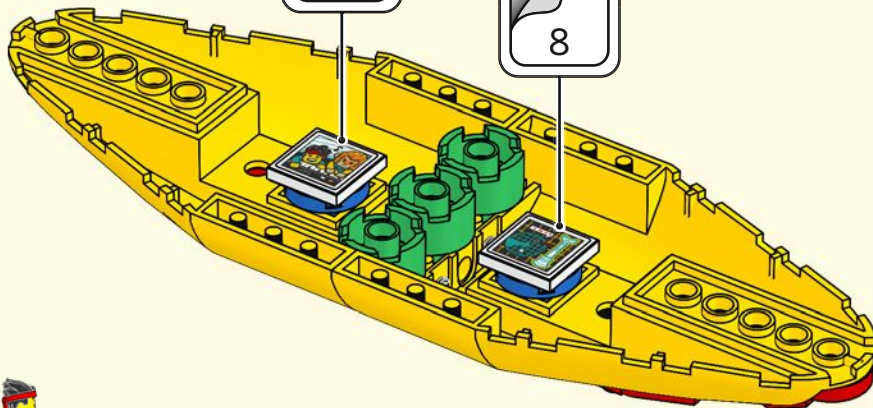

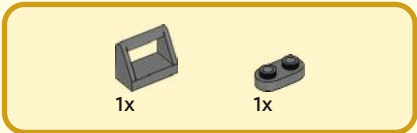

79

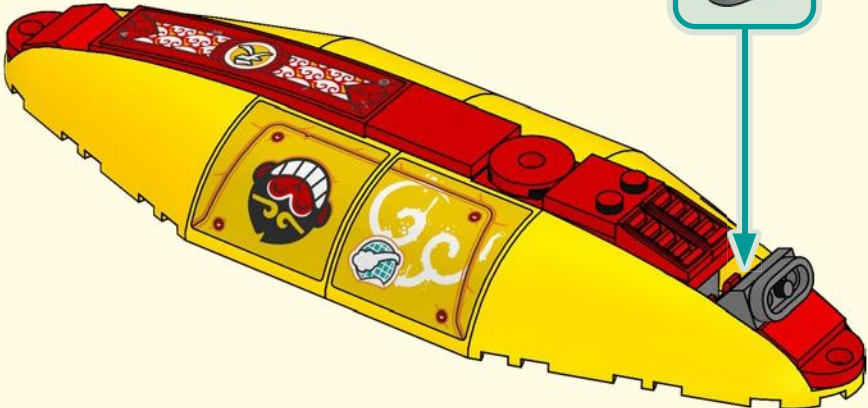
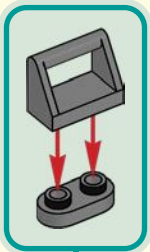



2x



2x

80

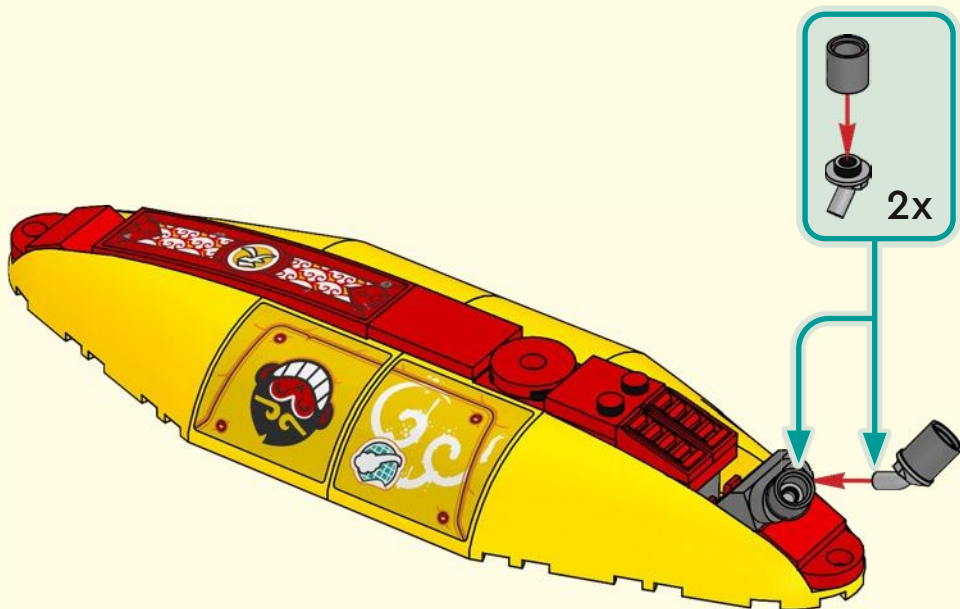

81

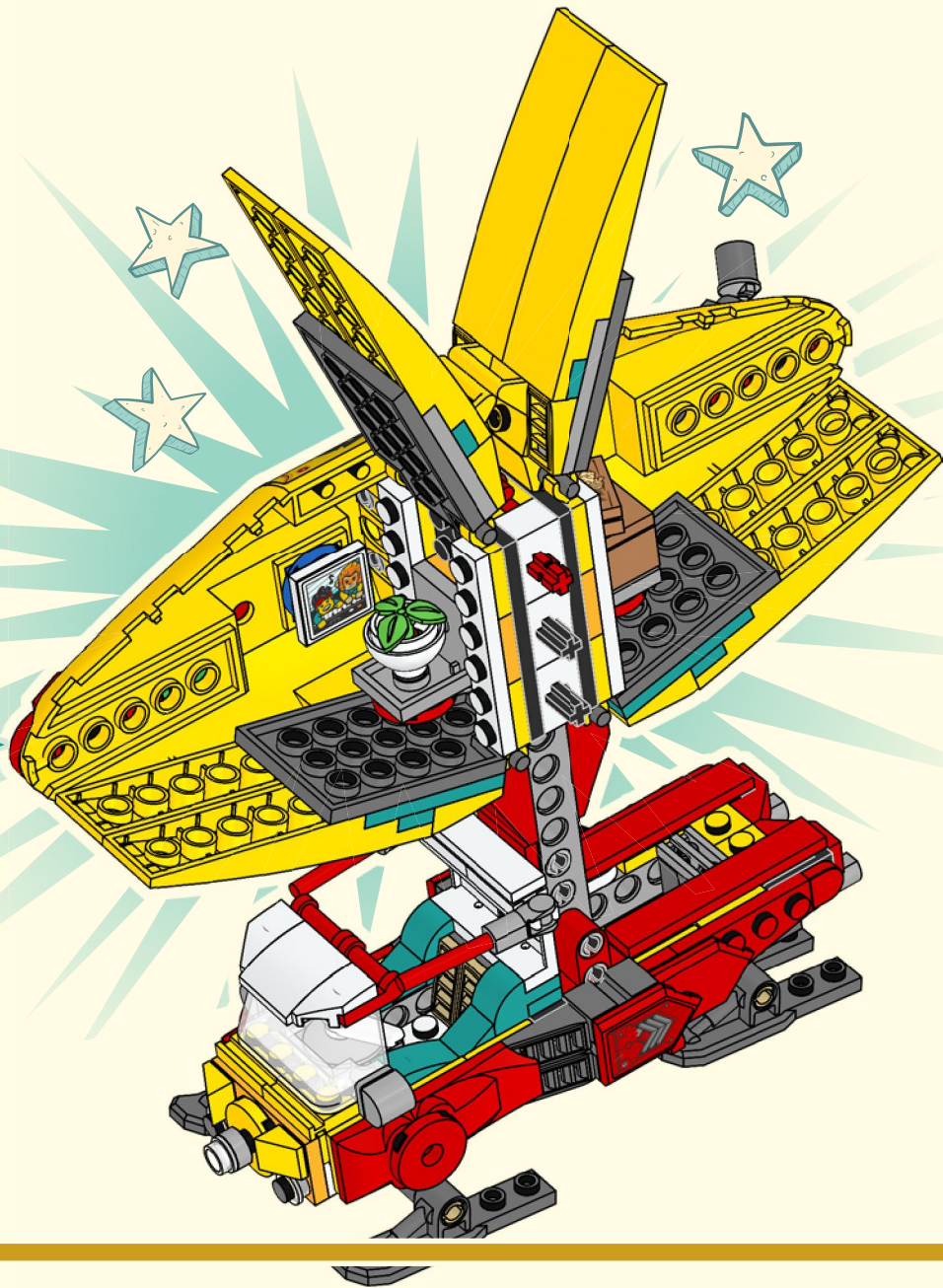



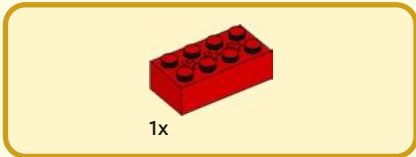

1x

82



2x

83

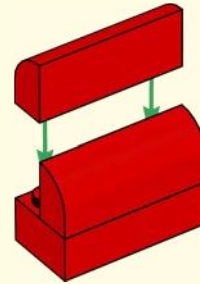

1x

84

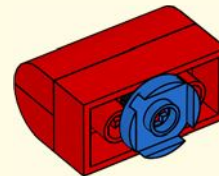



85

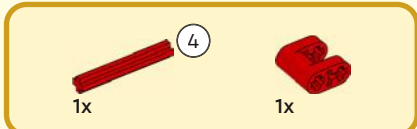
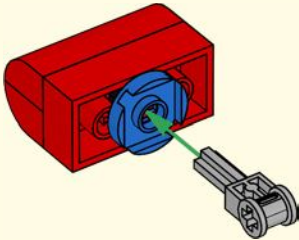

86

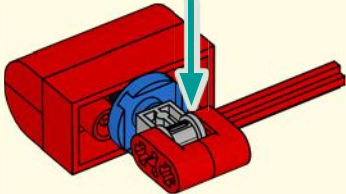
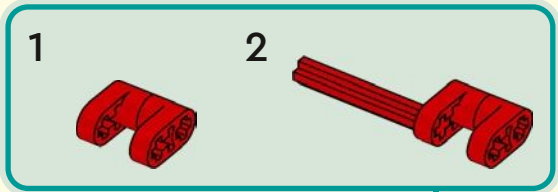

87

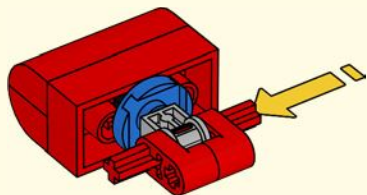

88

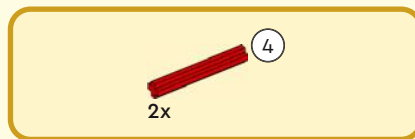
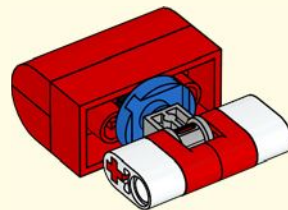
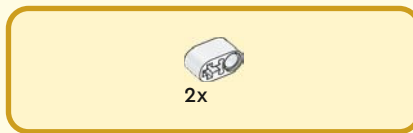

89

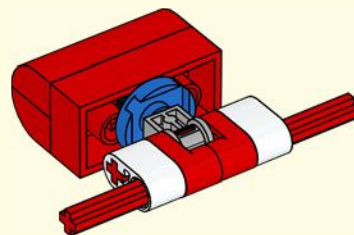
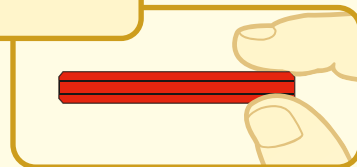

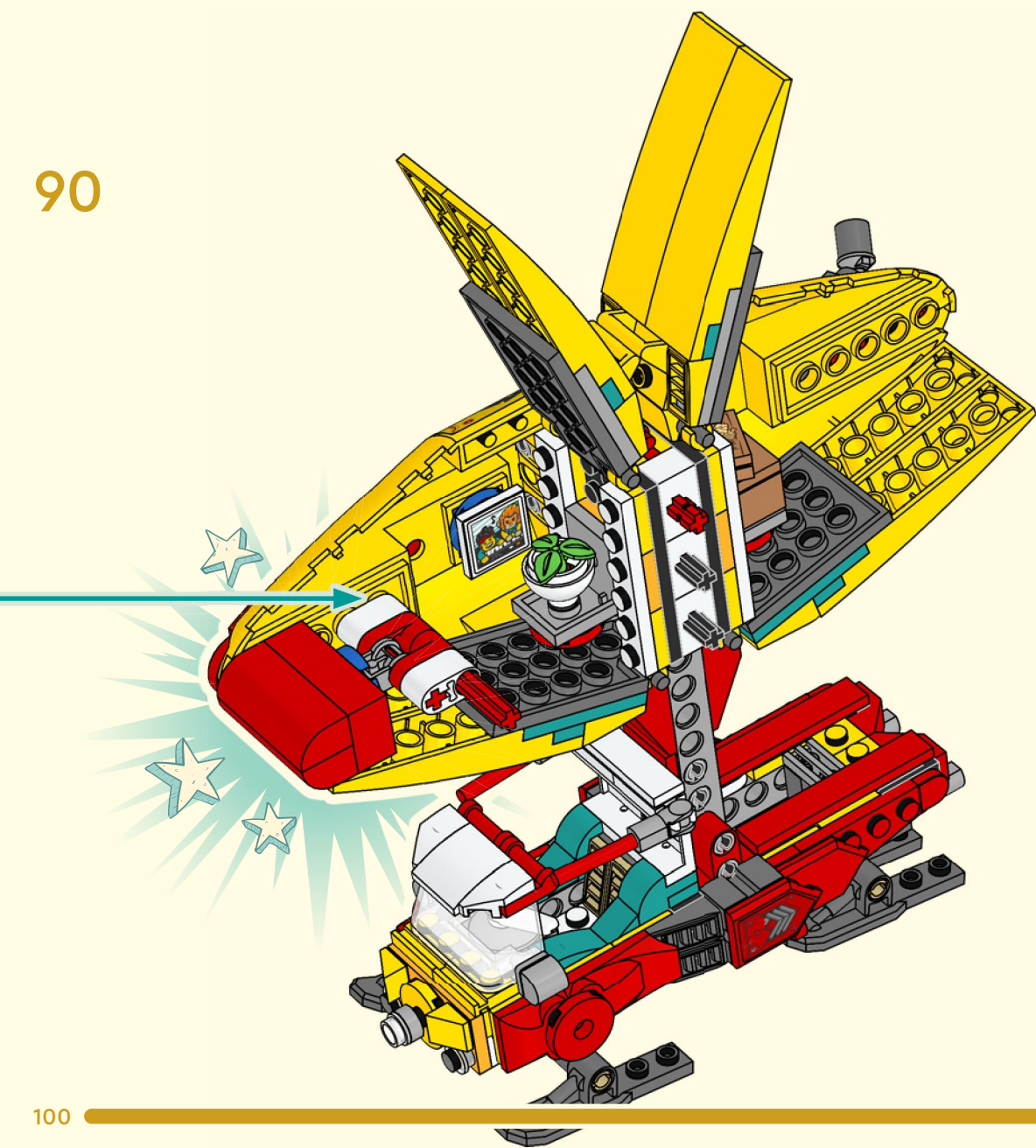

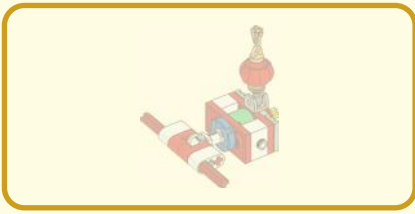

1x

1x

91

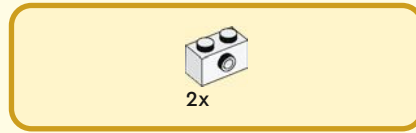

2x

92

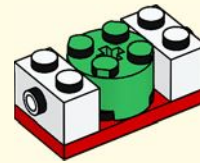



1x

93

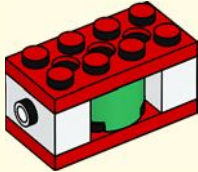

2x



1x

94

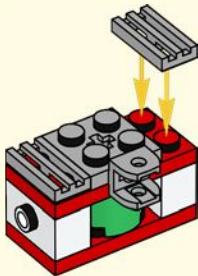

1x

95

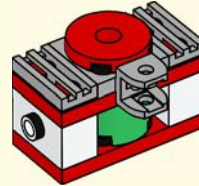

1x

96

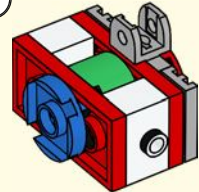

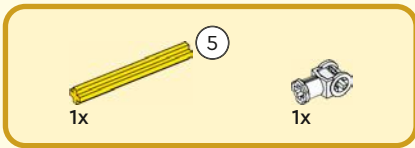

97

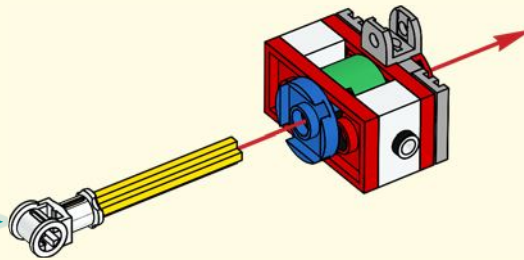
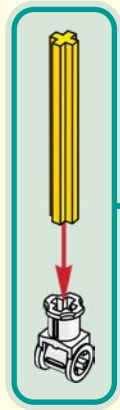
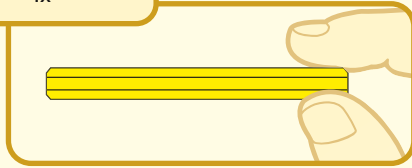

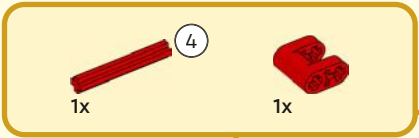

98

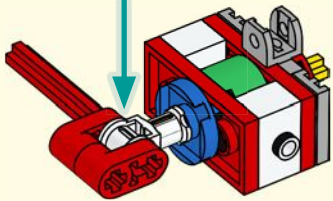
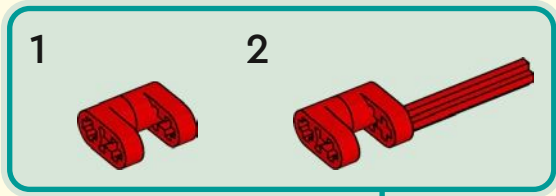
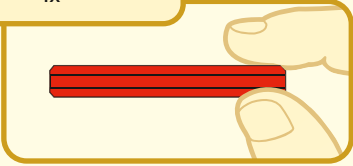

99

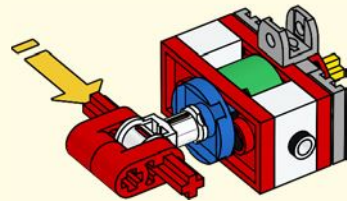





2x

100

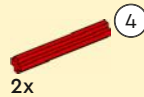
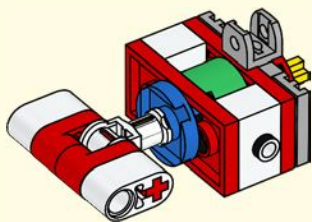

2x

101

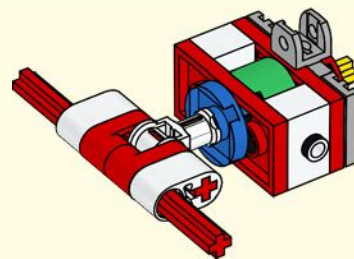
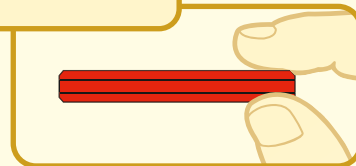

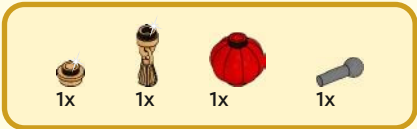

102

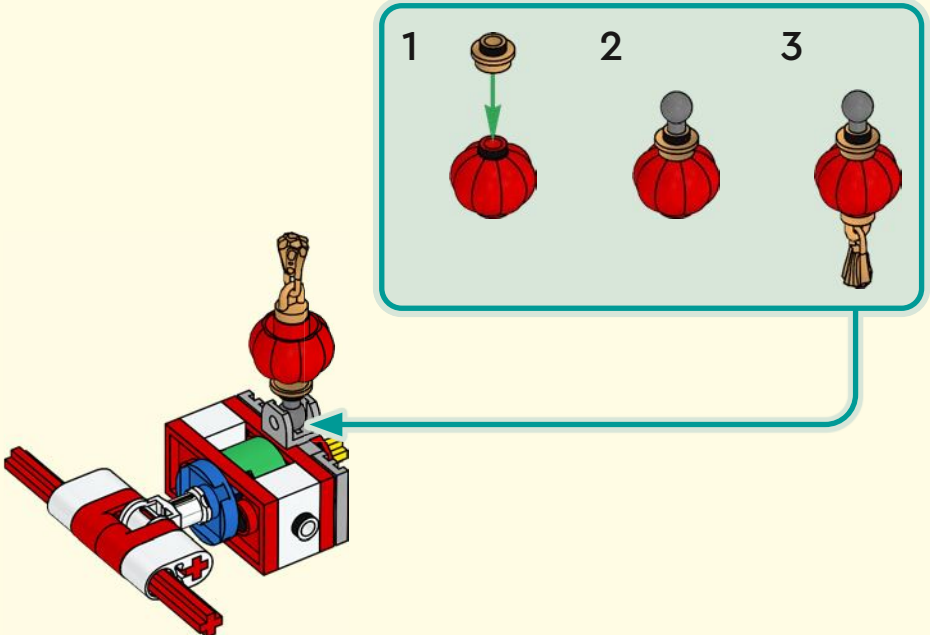

103

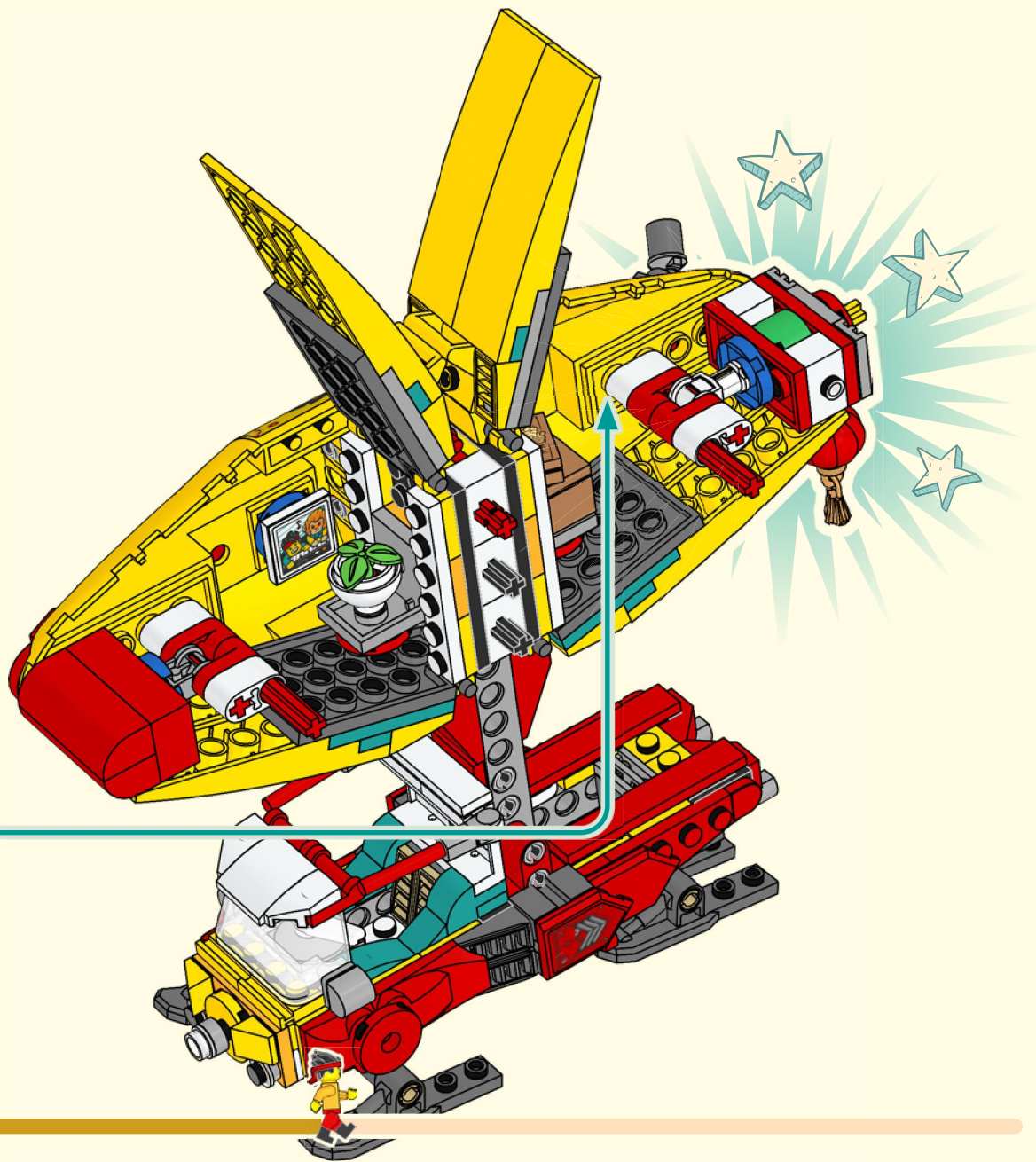

104

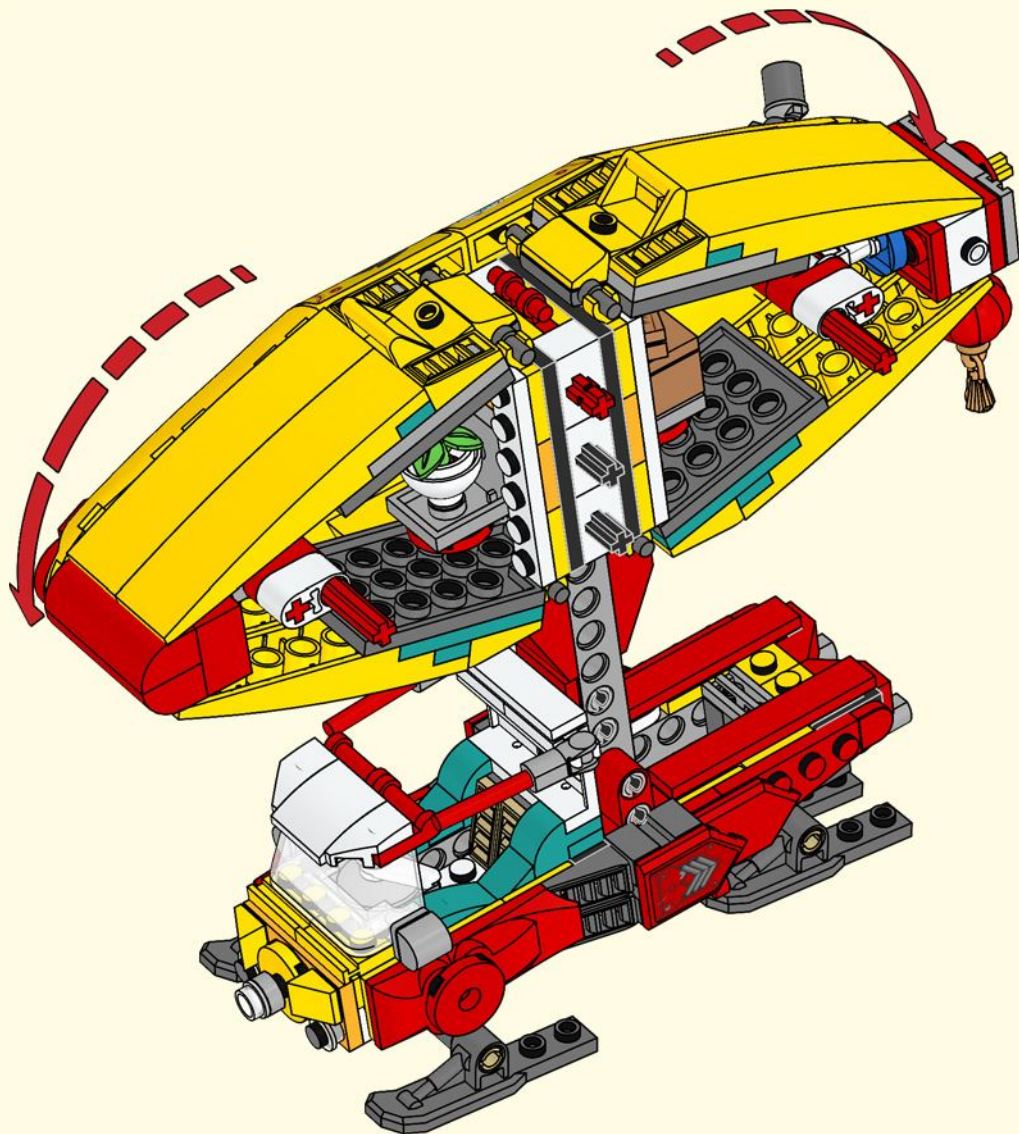

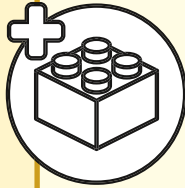
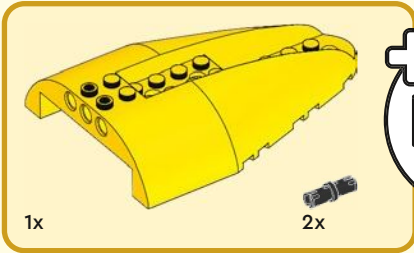

105

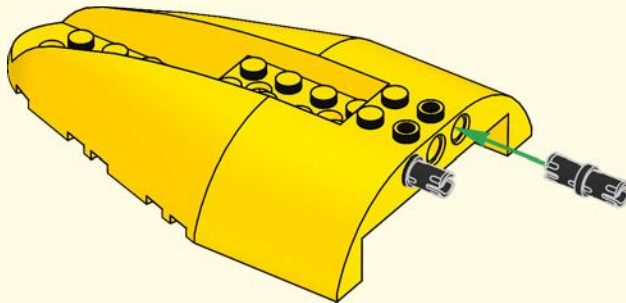

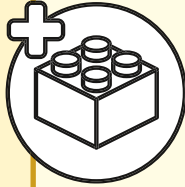
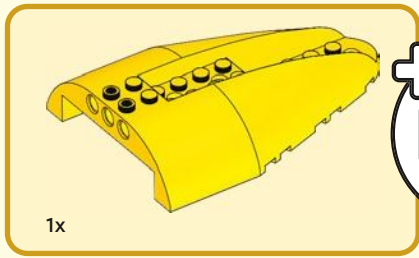

106

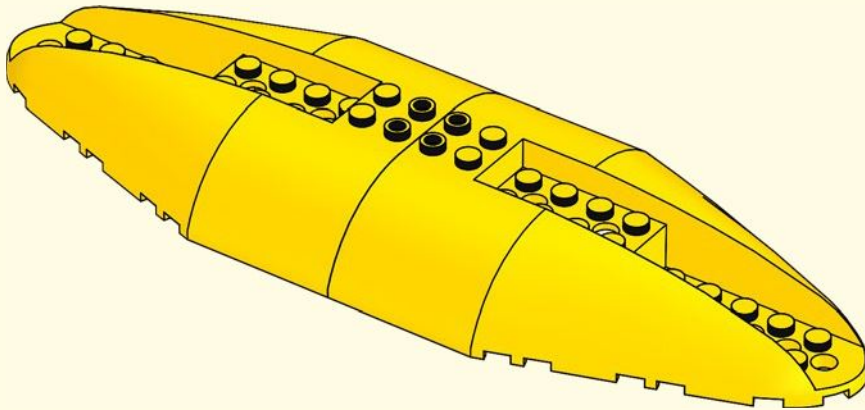



107

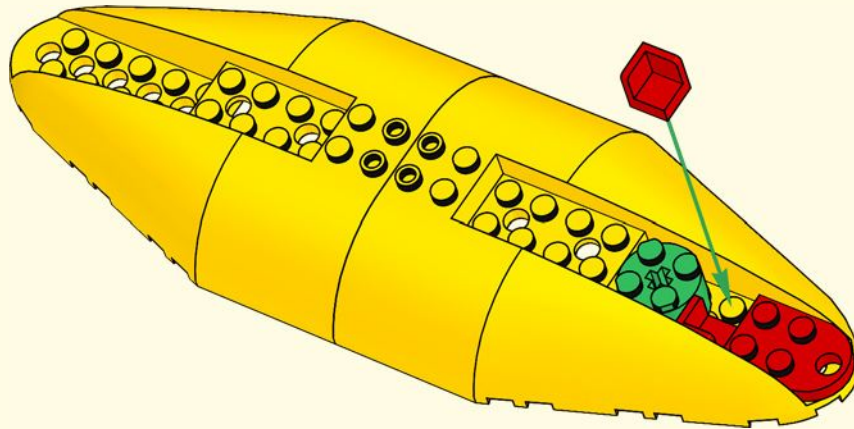

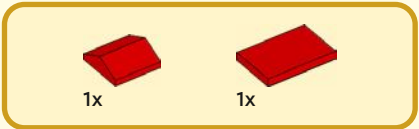

108

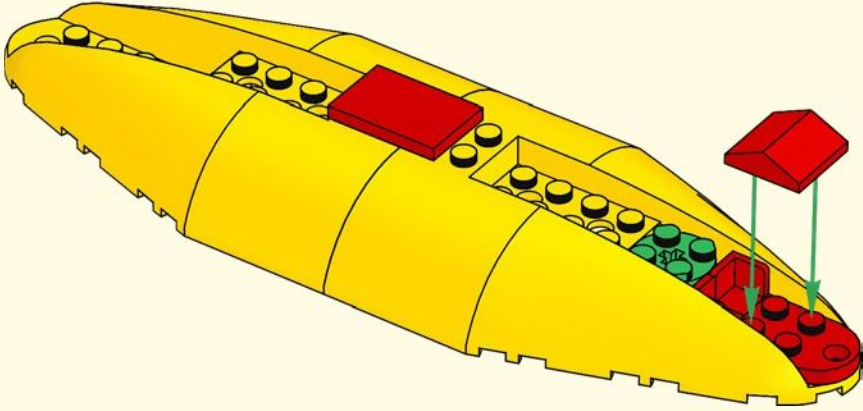



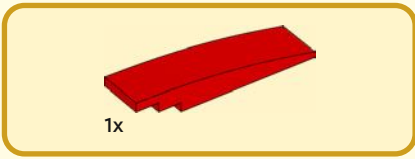

109

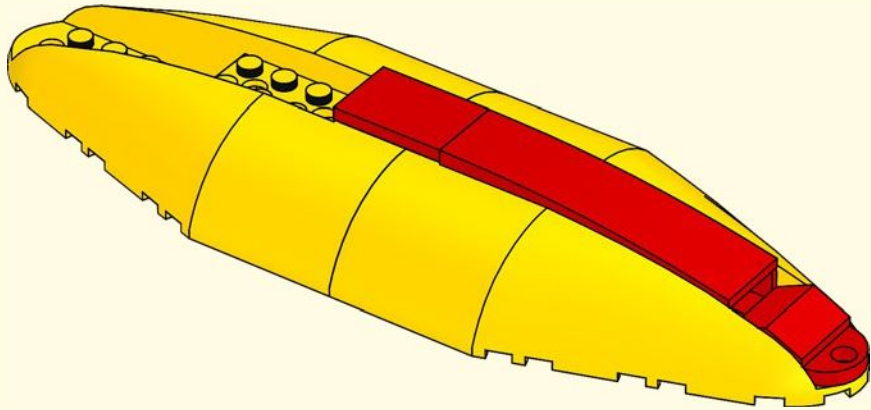



1x



2x

110

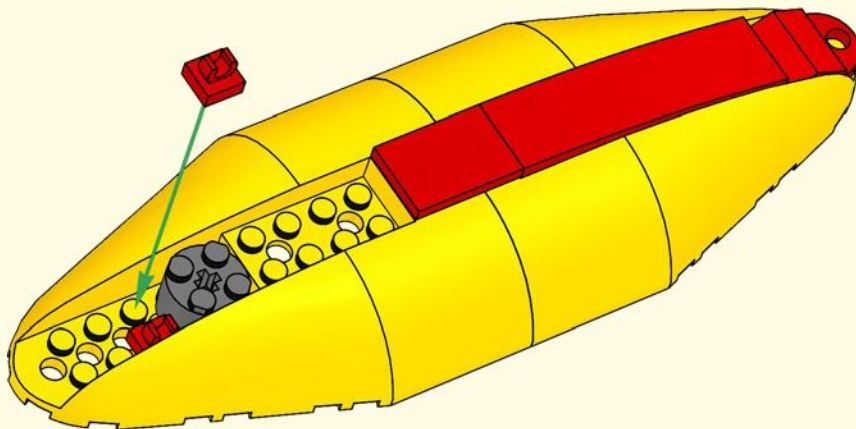

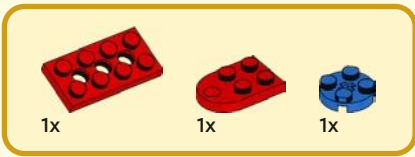

111

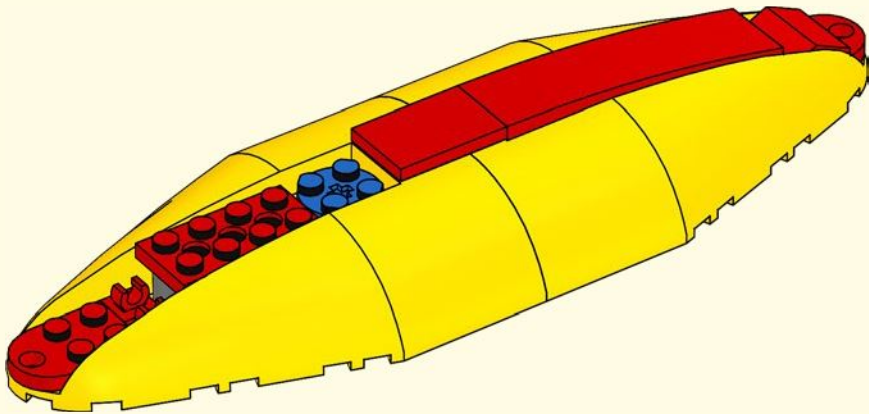

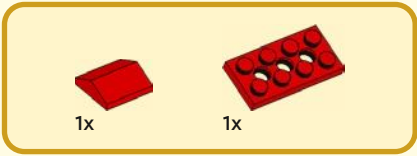

112

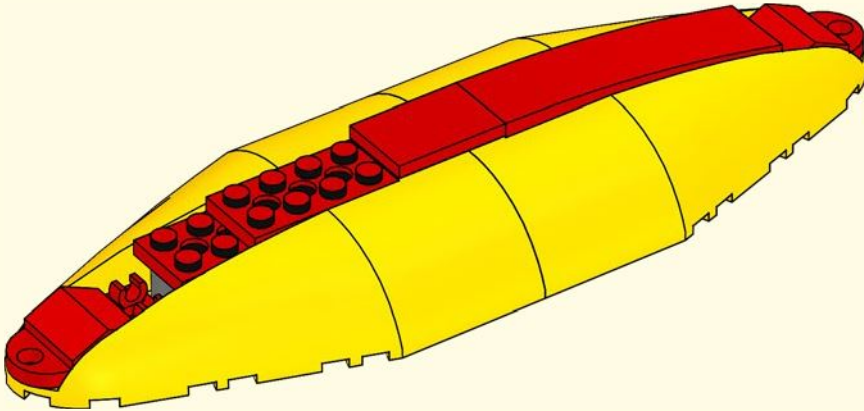



113

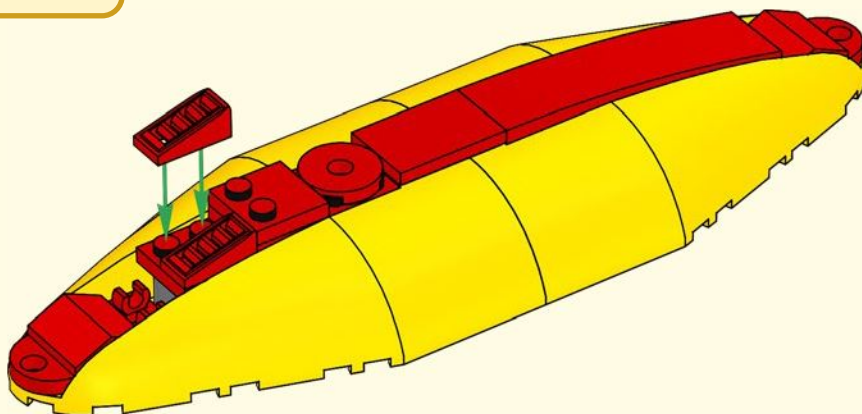

114

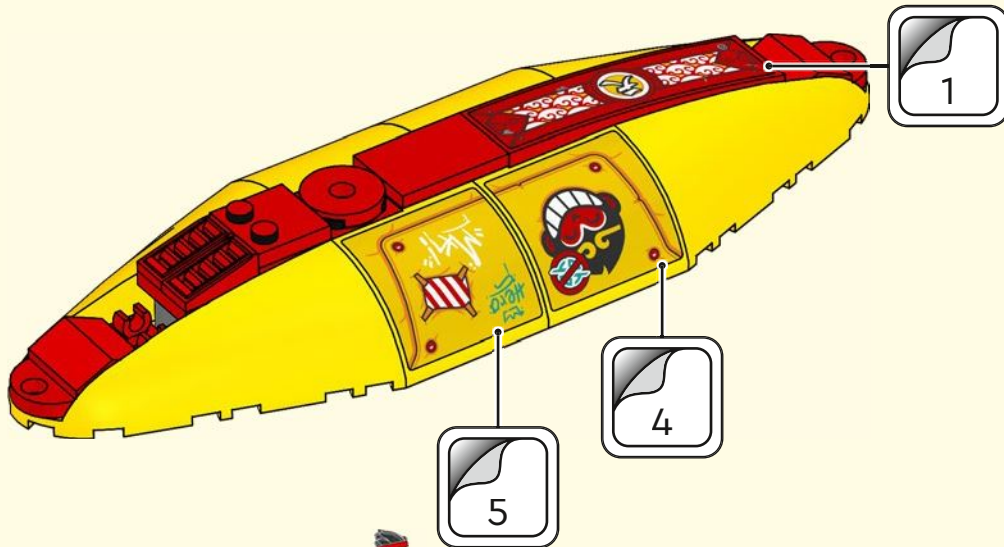



3x

115

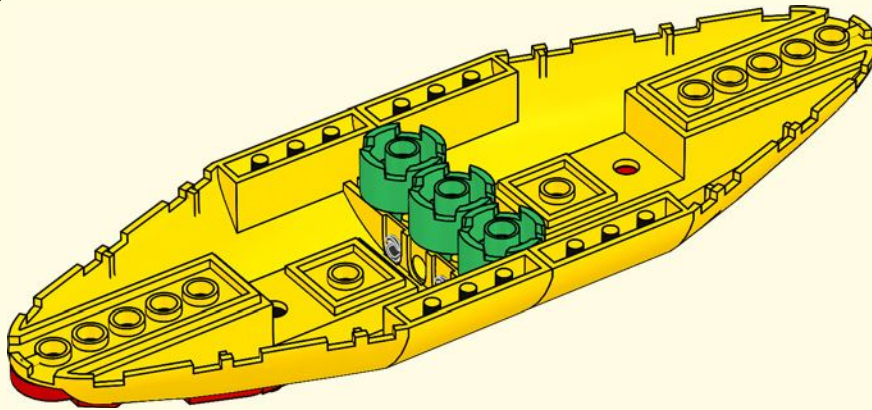



2x



2x

# 116

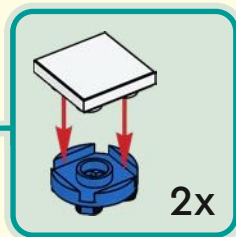
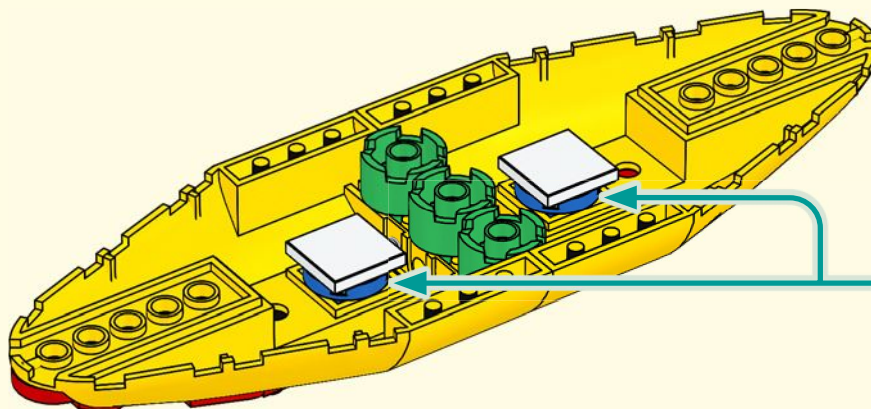

# 117

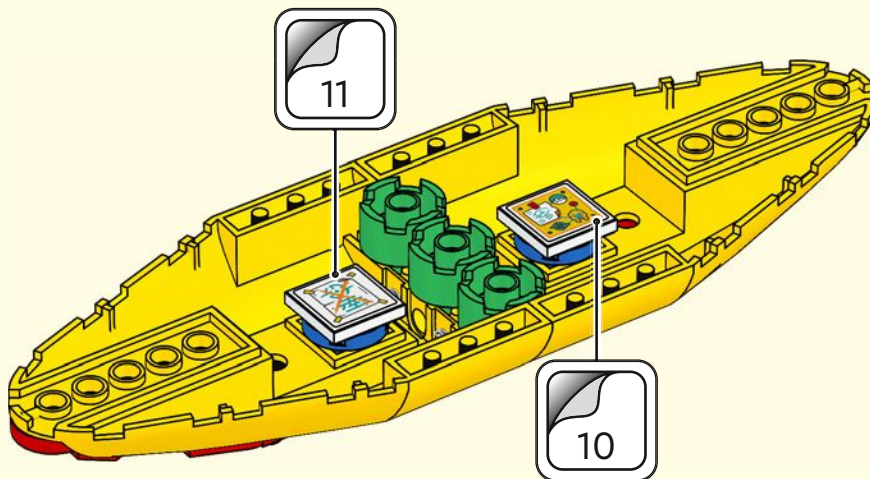

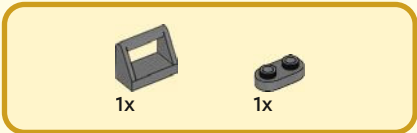

118

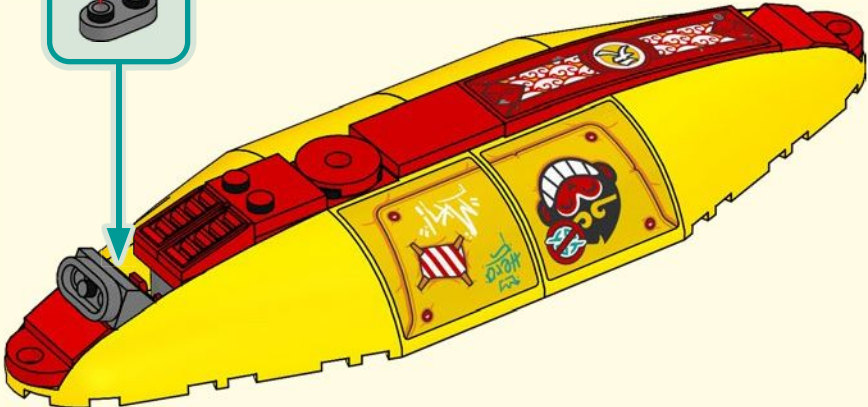
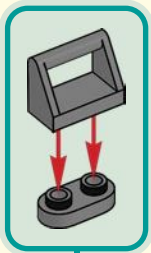





2x



2x

# 119

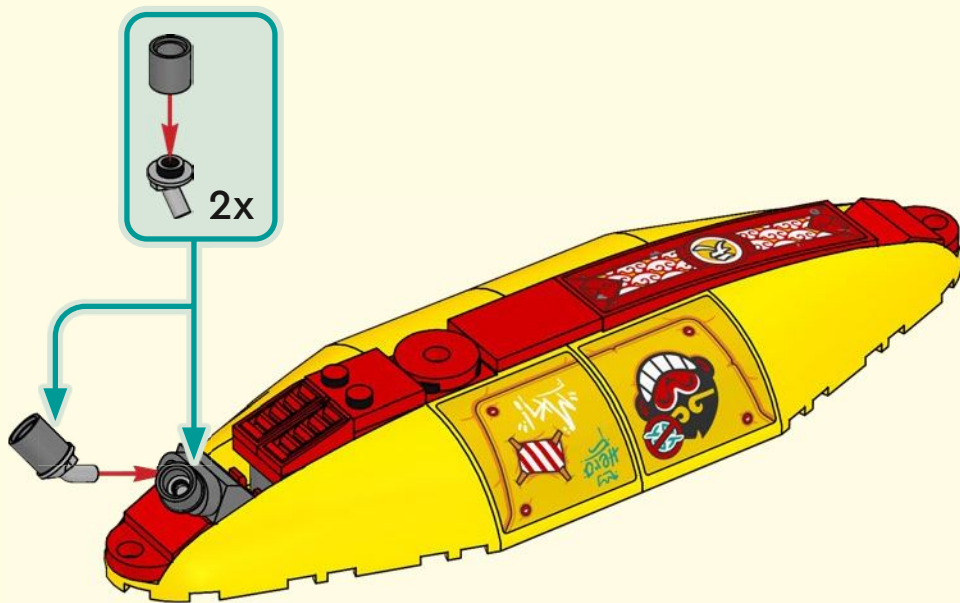

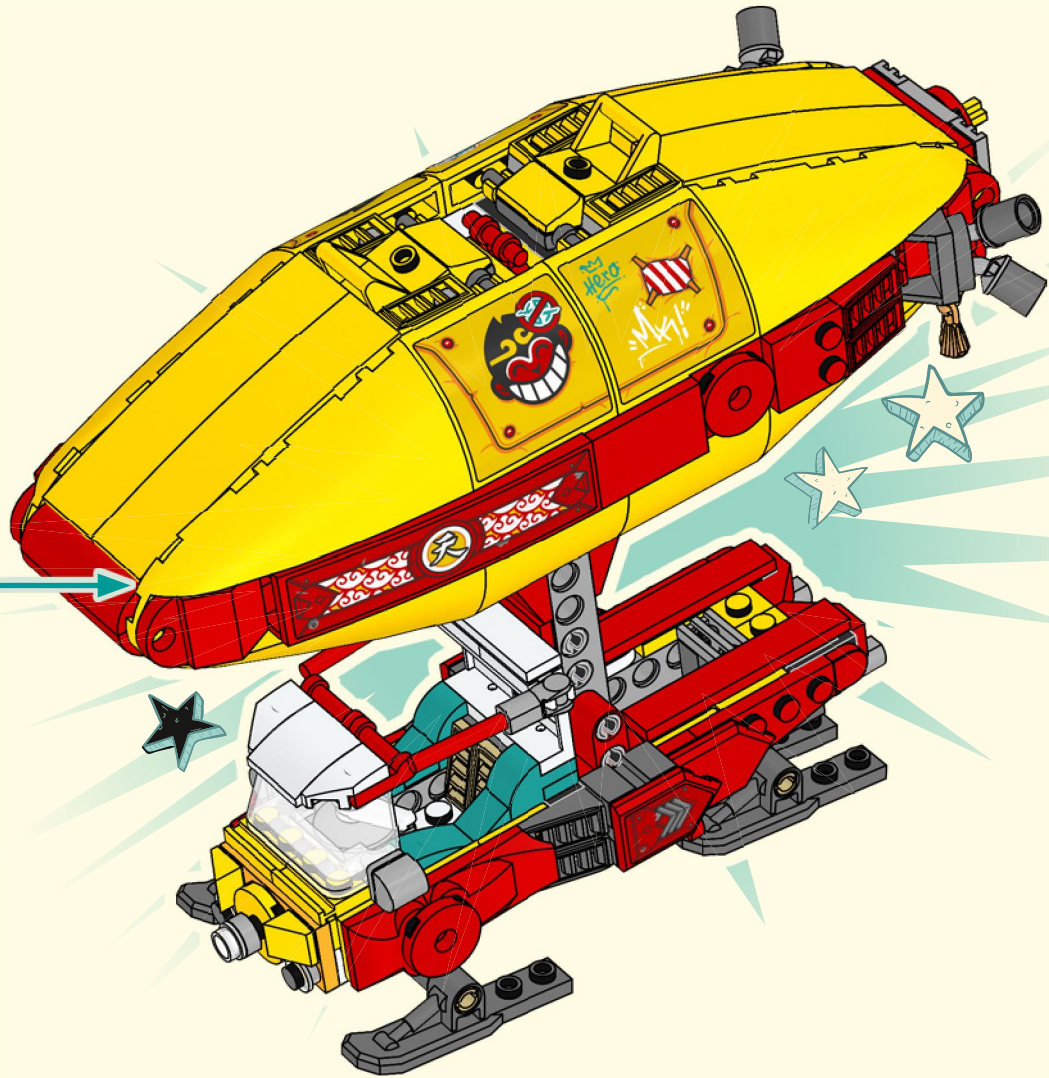





1

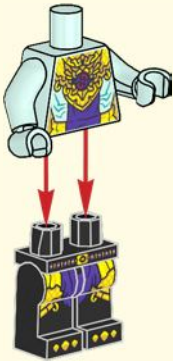

2

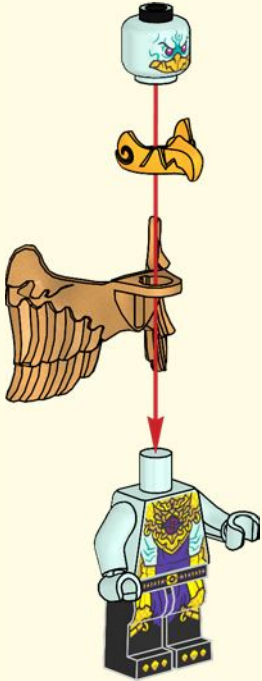



1x



1x

3



1x



1x



1x



1x

4

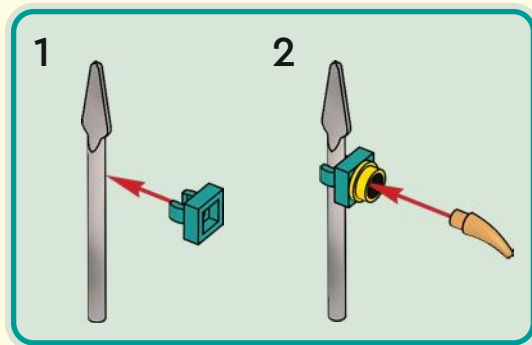

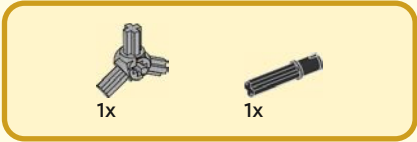
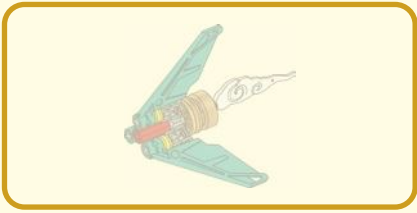

121

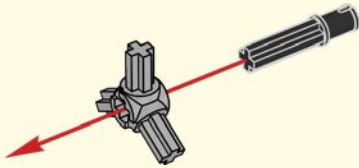

122

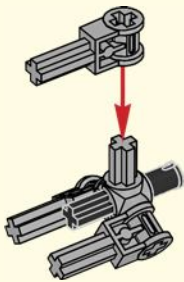

123

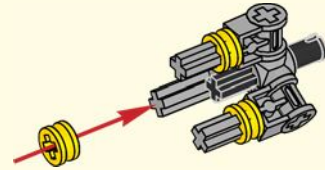

124

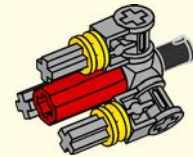



125

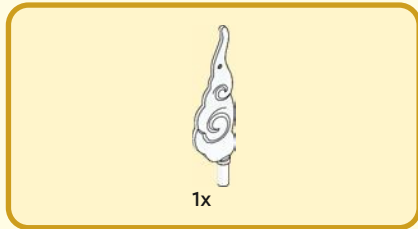
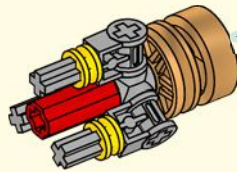
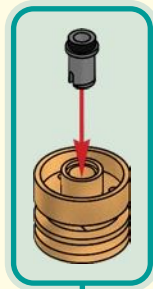

126

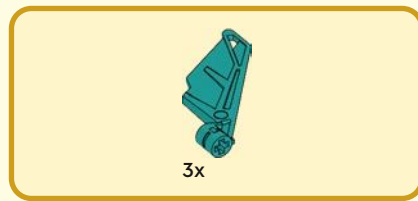
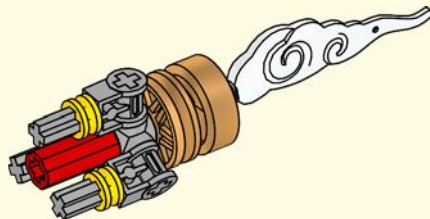

127

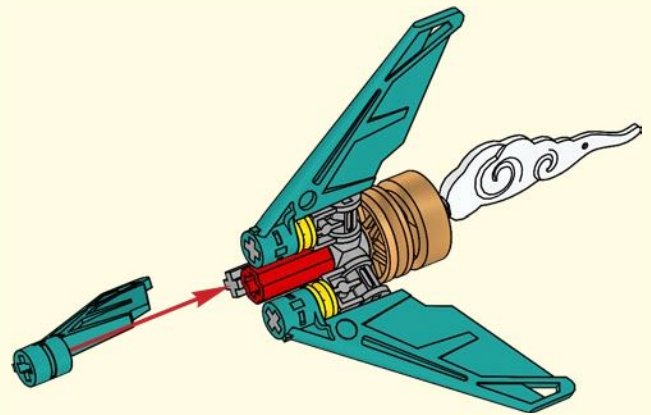

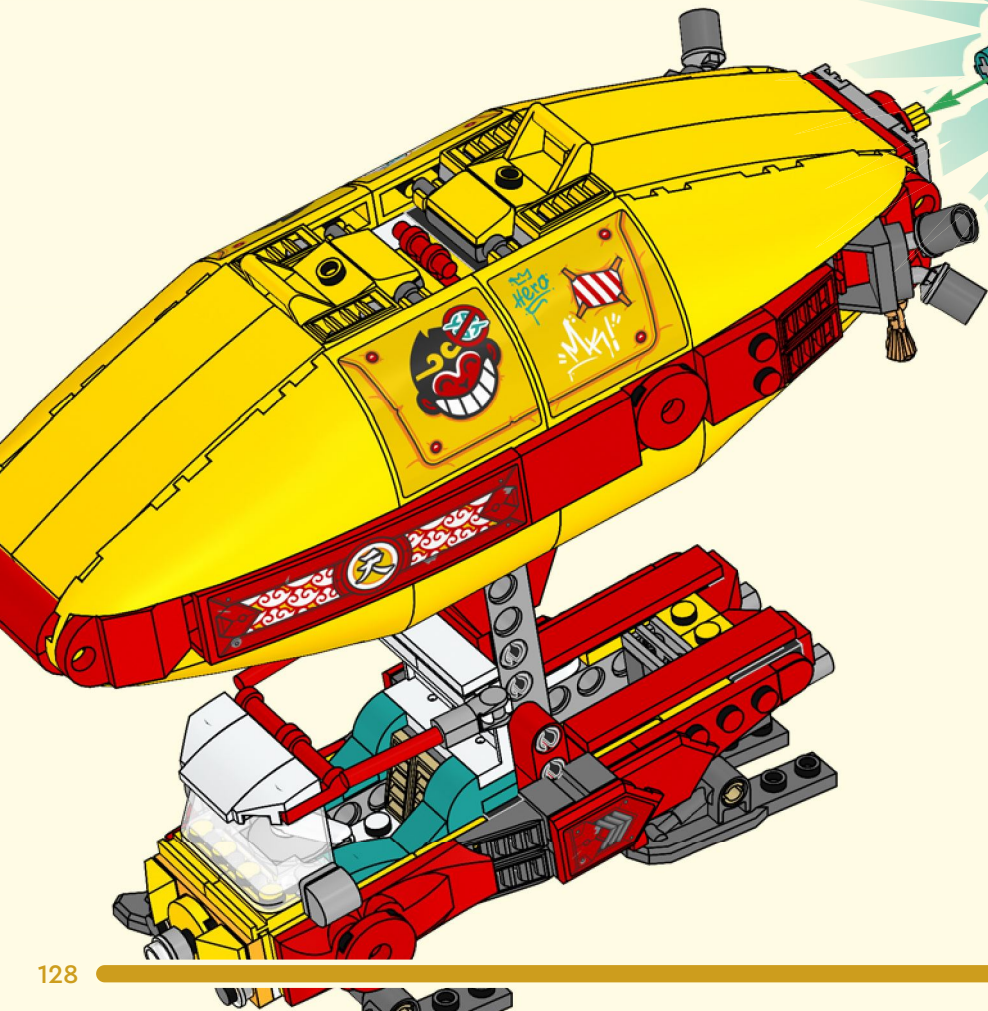



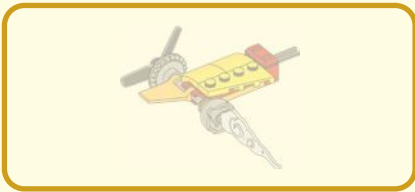

129

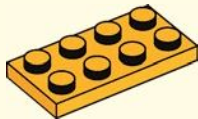

130

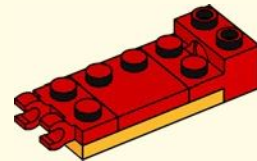



131

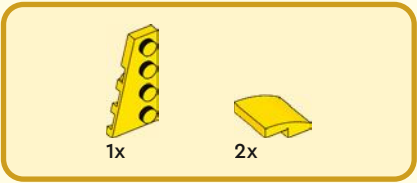
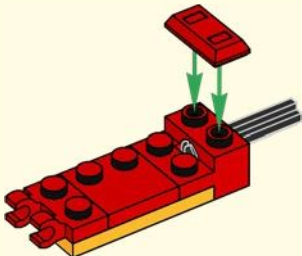

132

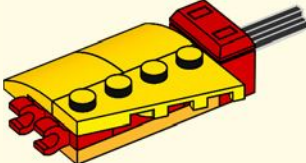

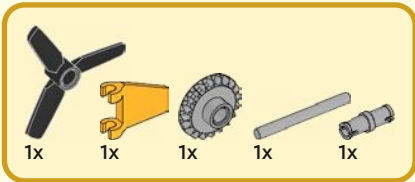

133

1



2



3

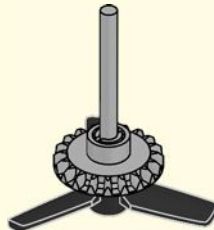

4

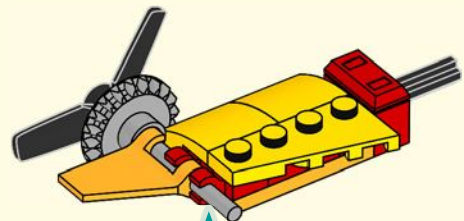
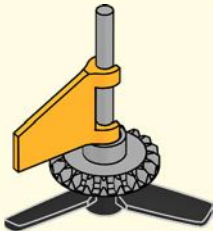

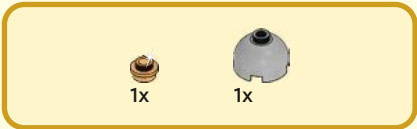

134

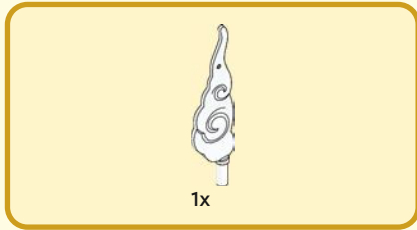
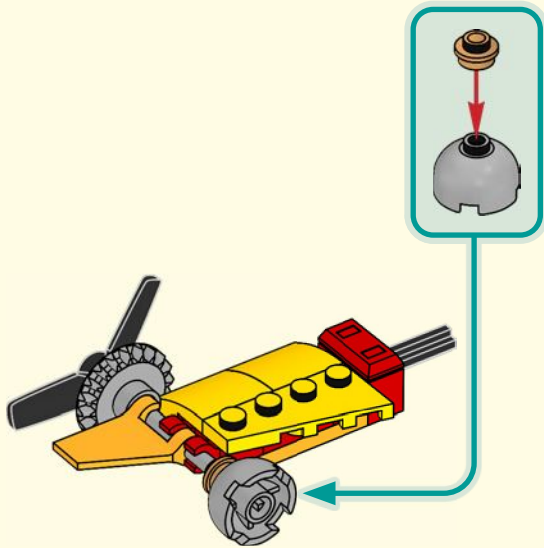

135

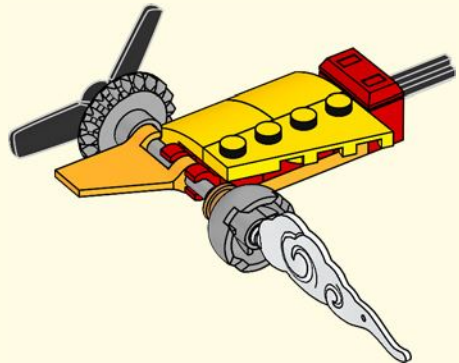

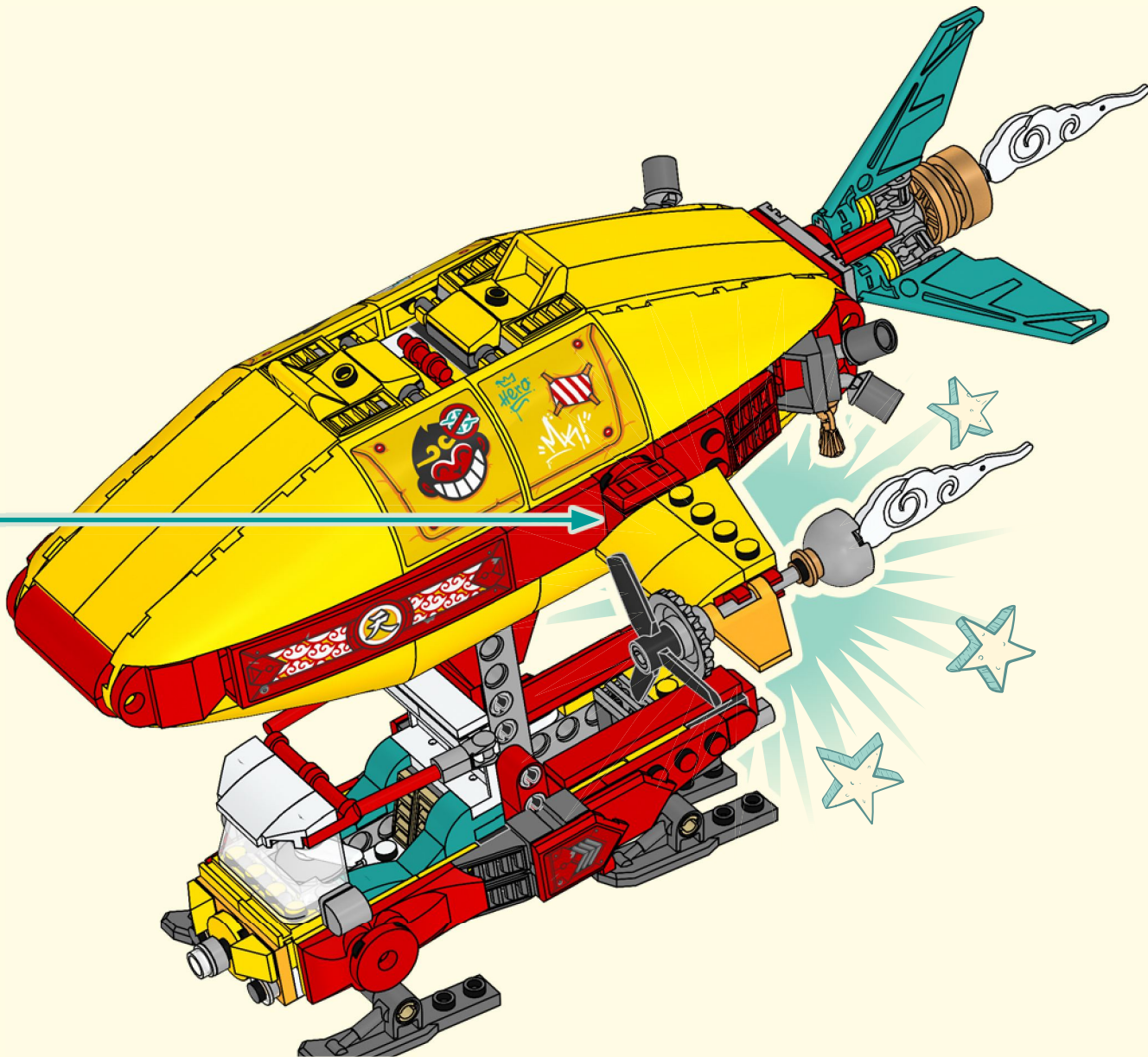

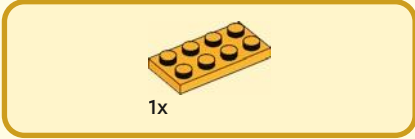

137

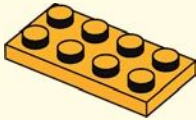

138

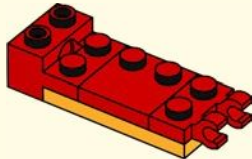

139

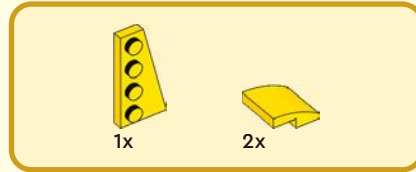
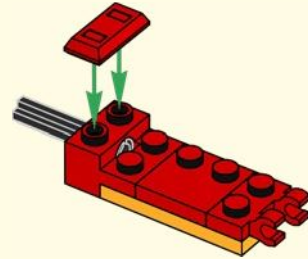

140

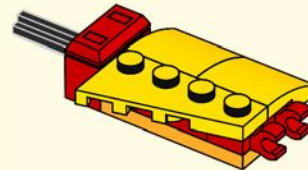

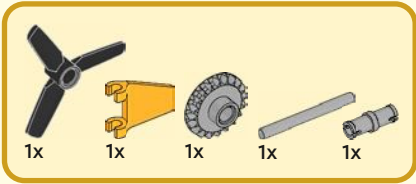

141

1



2



3





4





142

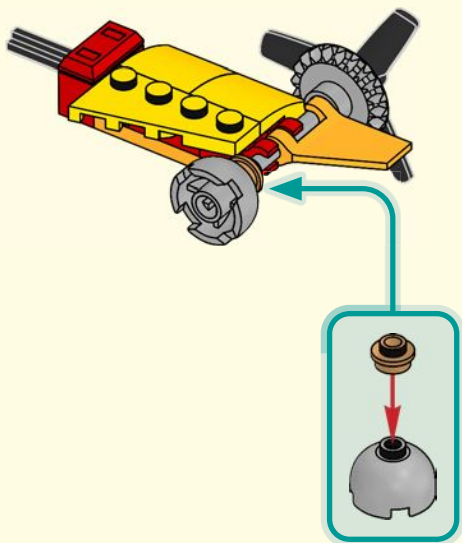

143

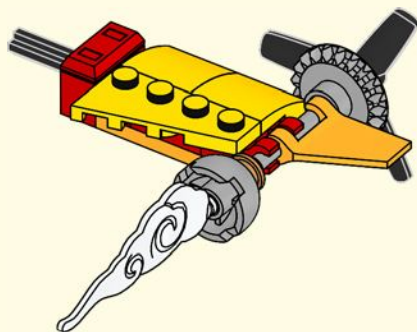

144

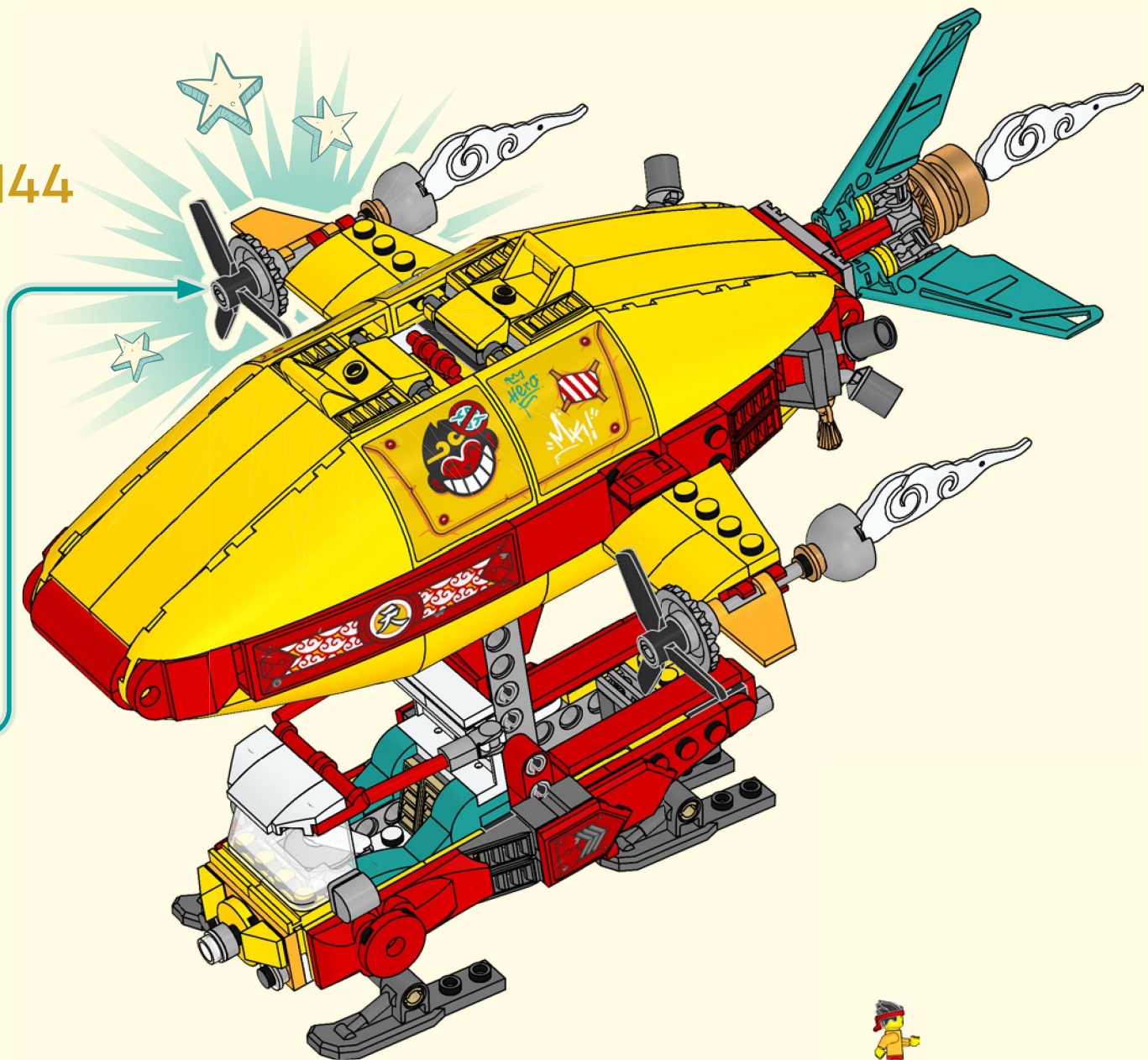



145



146



147



148

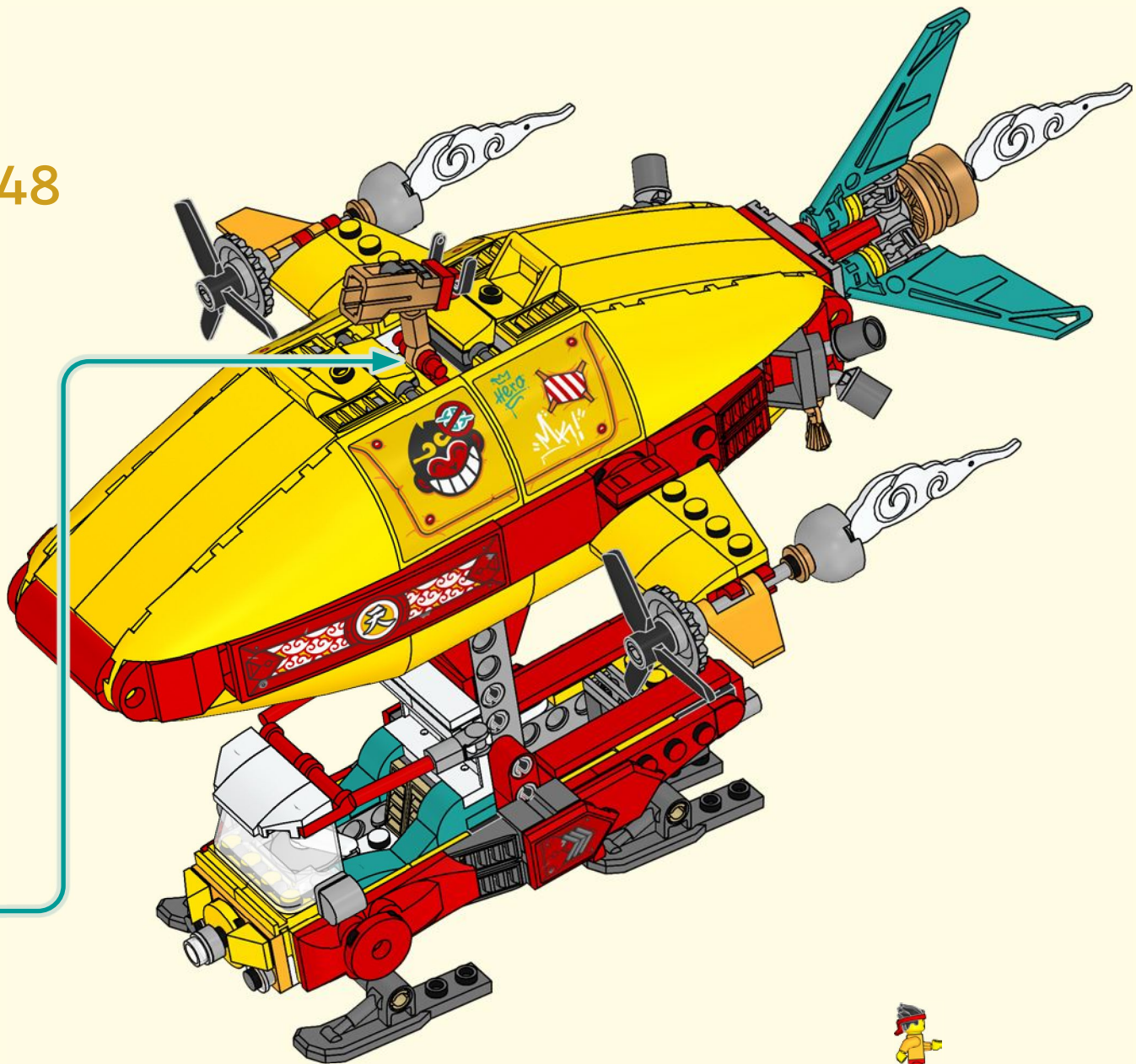

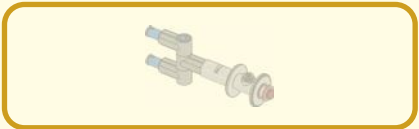

149

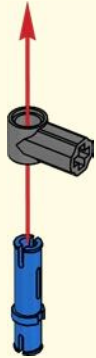

150



151

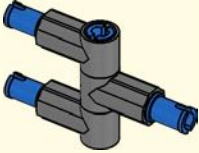



1x



1x

# 152

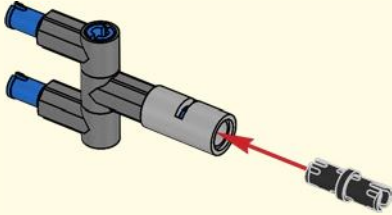

1x

# 153

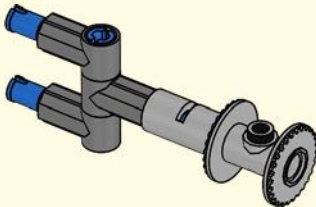

1x



1x

# 154

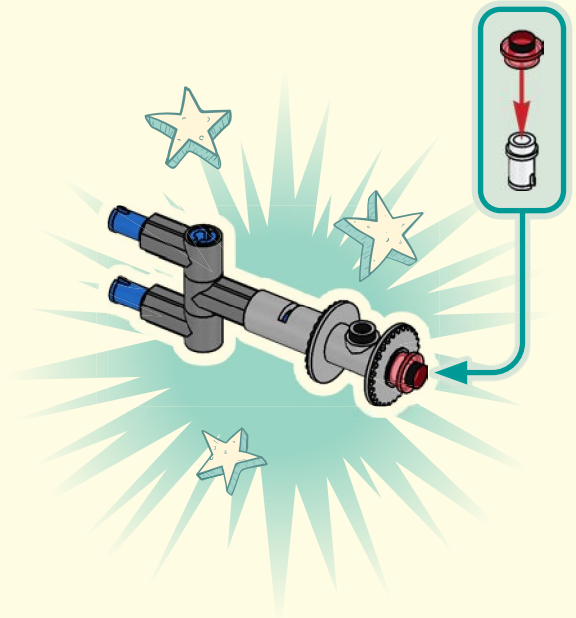

155

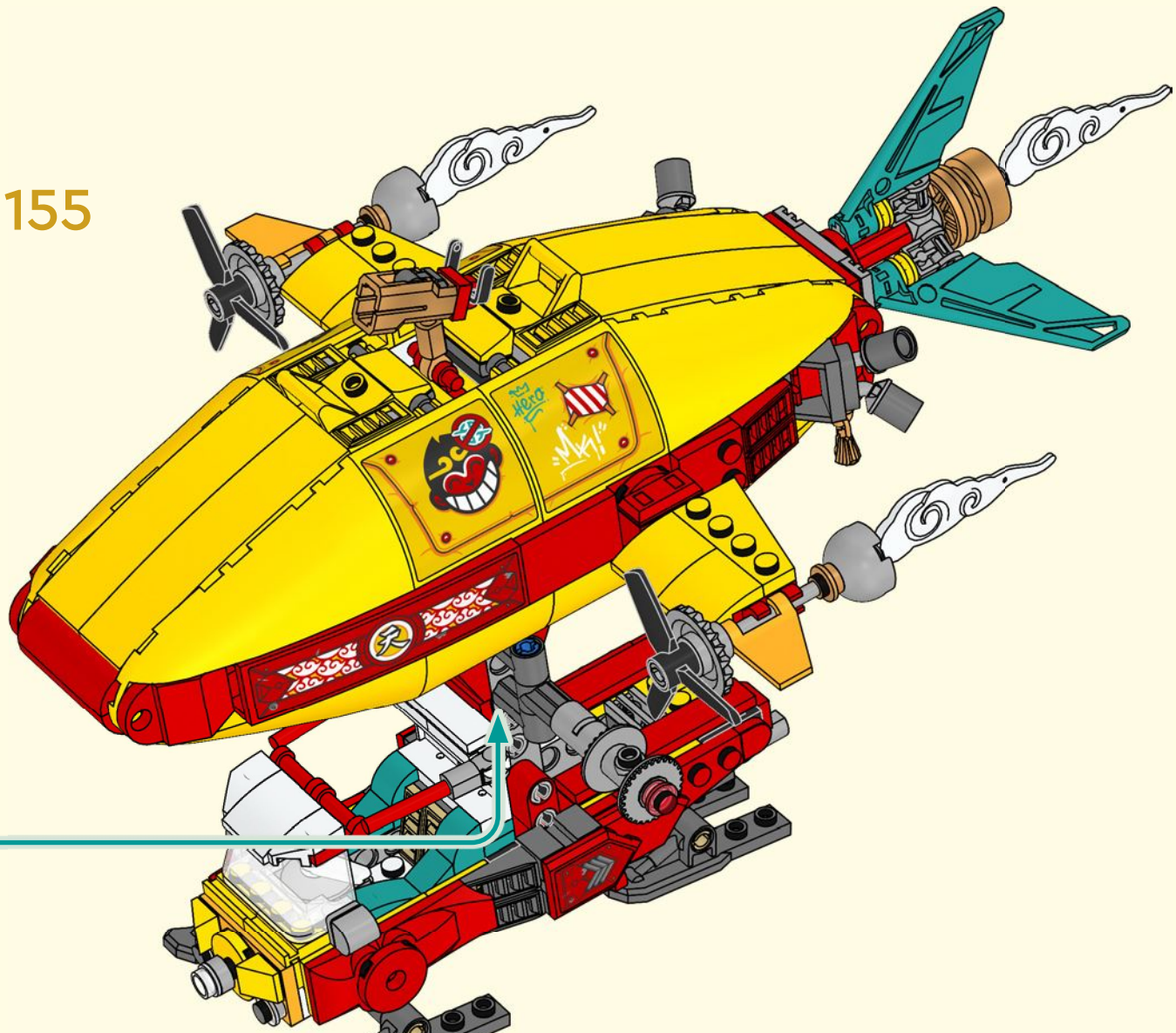



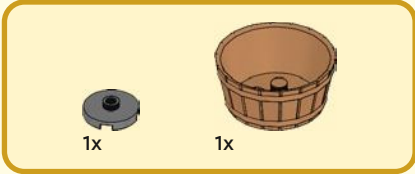

156

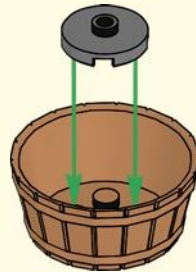

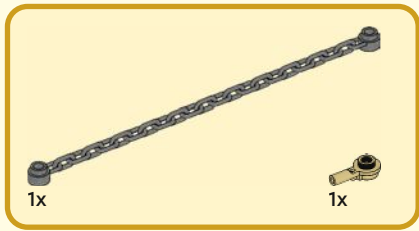

157

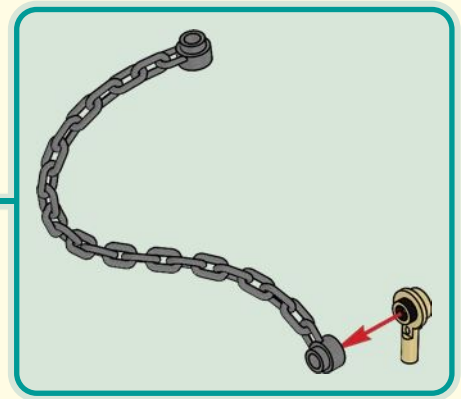

158

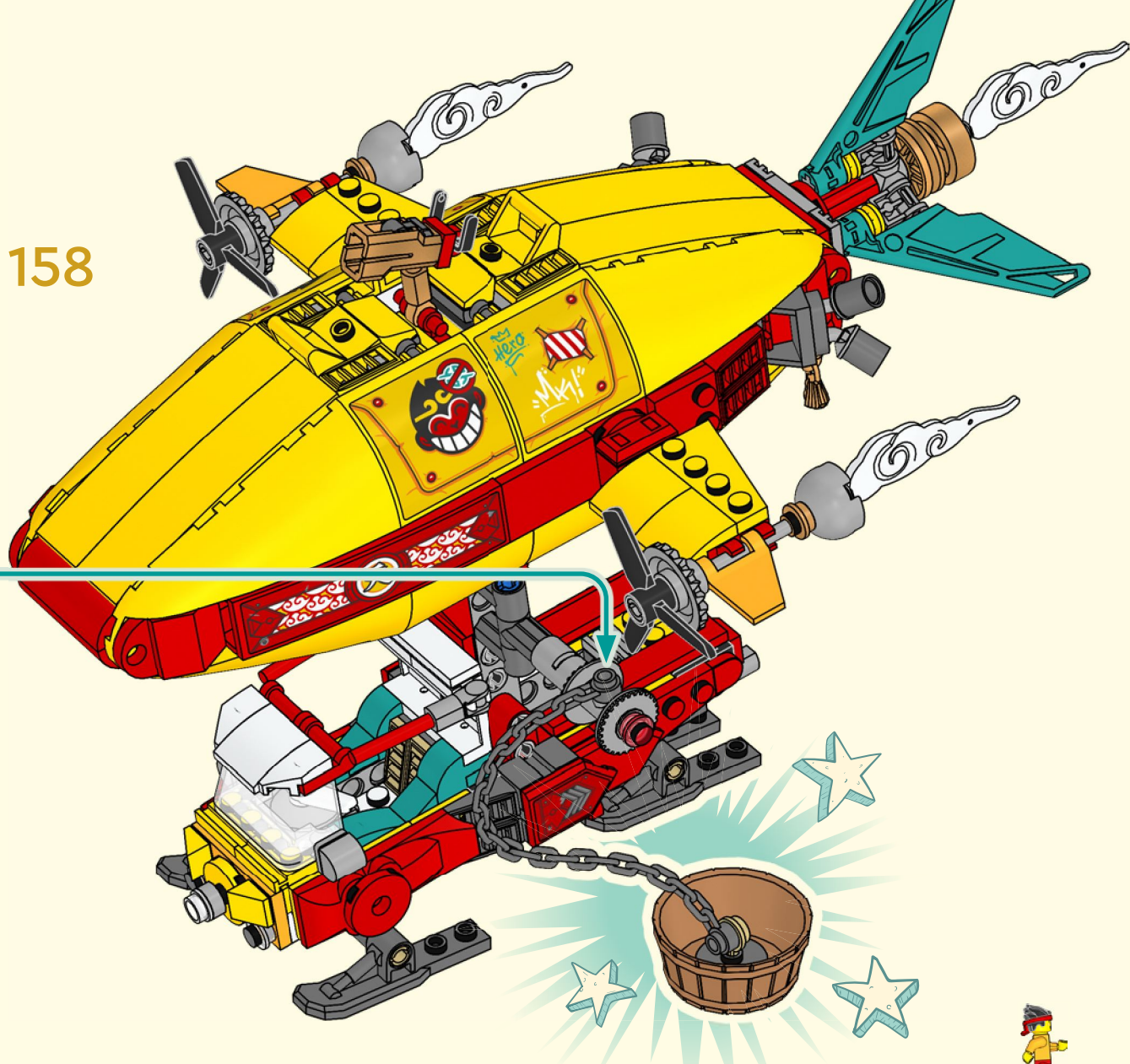



2x

159



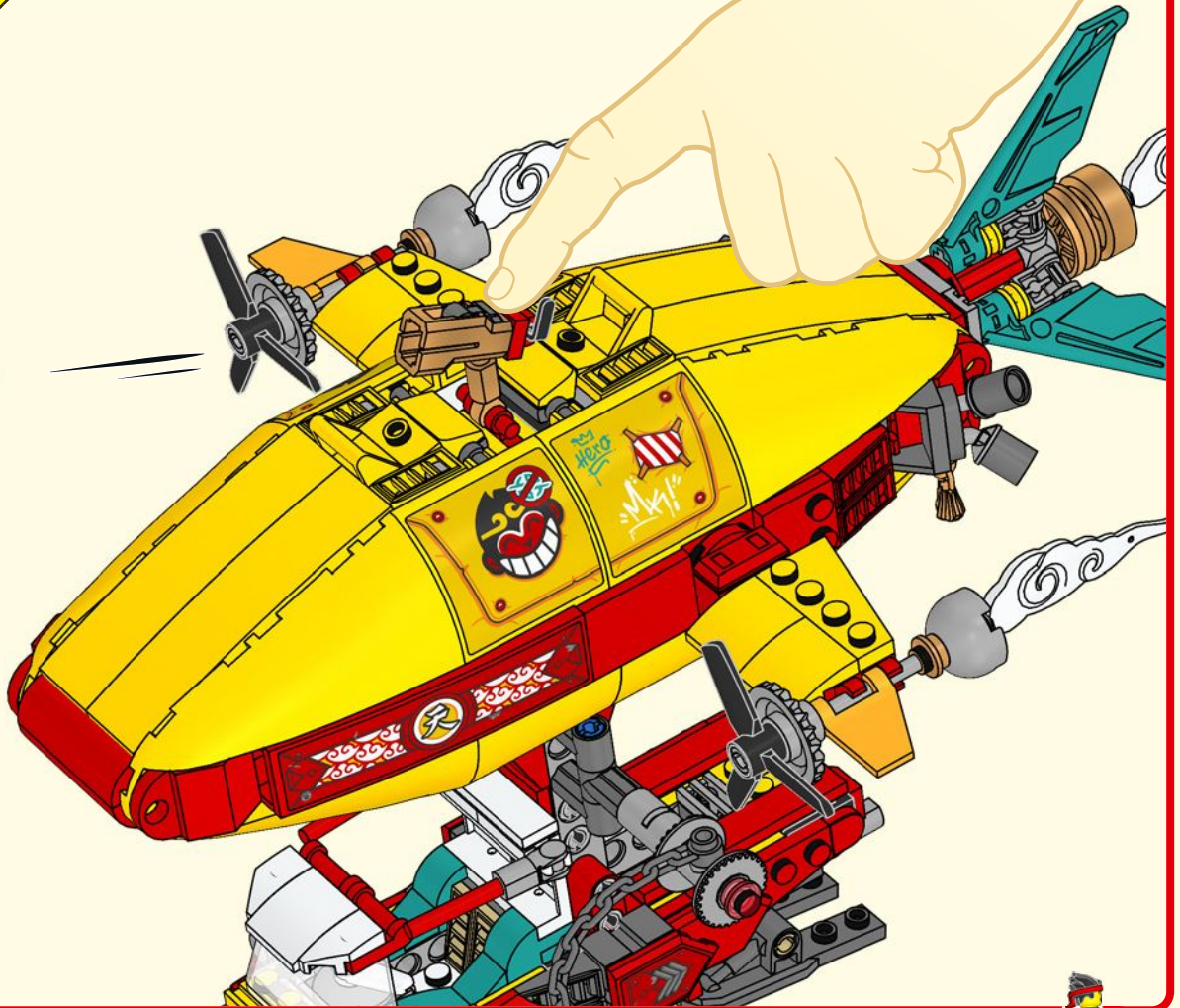

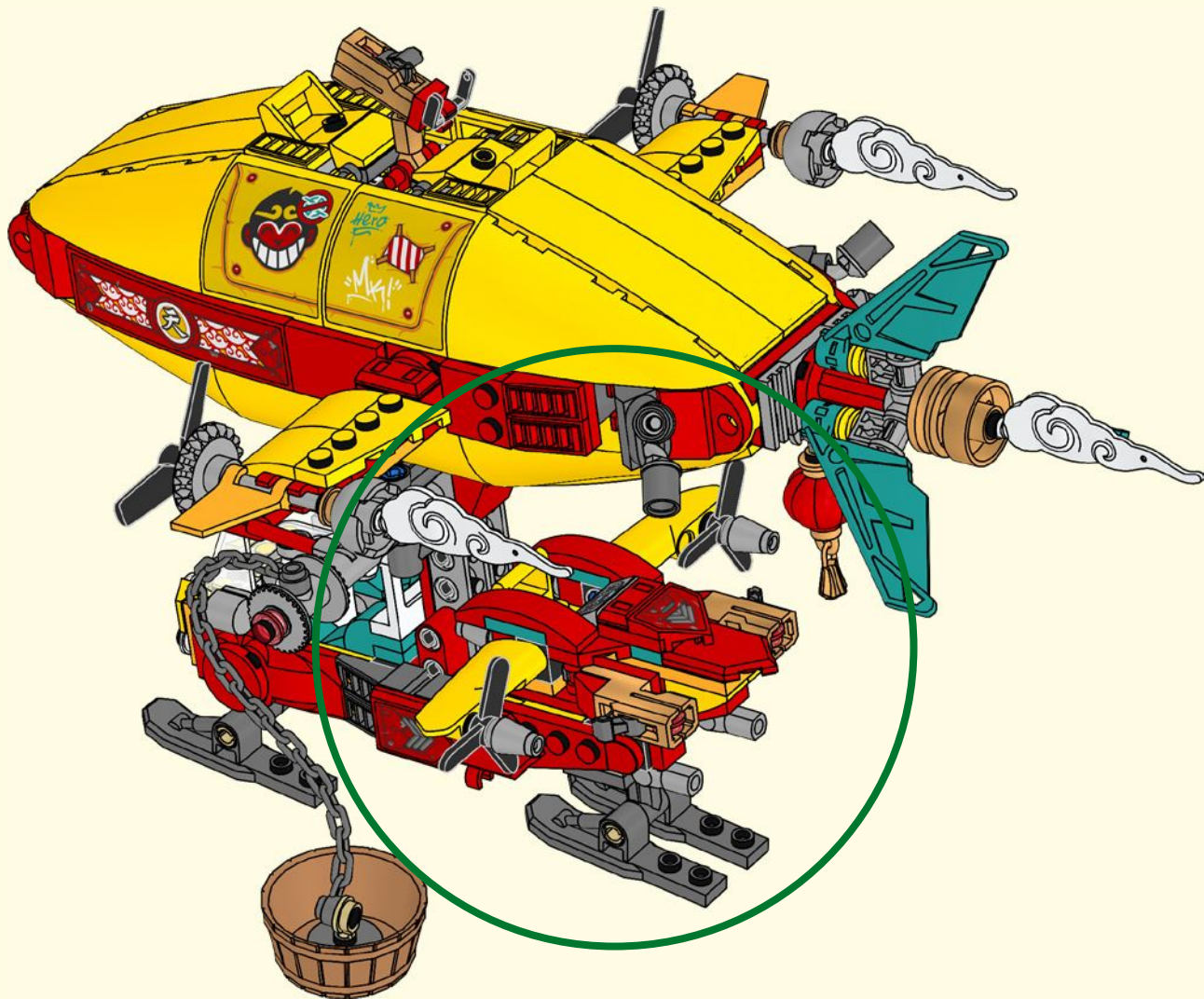





# MONKIE KID 悟空小侠™





4x 614101	1x 6211335	2x 4504379	2x 4207715	2x 4515365	2x 4113858	1x 4161331
1x 6424009	2x 6372037	4x 4190219	4x 4540382	5x 6294045	1x 6335578	1x 6352653
1x 6388018	4x 6013866	5x 6348058	2x 6360036	4x 4188189	2x 6321762	2x 4550348
1x 6213880	1x 6047220	1x 4160866	1x 4140585	1x 4500462	5x 4206482	1x 6299764
	2x 302101	1x 4161329	2x 6346804	1x 6296954	8x 403223	3x 243224
3x 6316325	1x 243101	1x 6293279	2x 4226876	1x 329821	1x 6299413	12x 4540384
2x 6210272	1x 4521846	7x 6102138	2x 6275080	2x 6189130	4x 6271167	2x 6092583
1x 6213881	1x 6053026	2x 4142865	2x 6359066	6x 6129995	5x 6168644	4x 6208753
1x 6050914	4x 366601	1x 6366640	2x 302221	2x 6143425	1x 6296324	4x 6185994
4x 6265135	1x 6286492	1x 4513174	2x 4220515	2x 4633914	2x 4504381	2x 4141630
1x 6417498	2x 6294481	1x 6305047	4x 330021	2x 6083618	2x 6280475	8x 6347284
1x 6375684	3x 6321305	3x 6394880	4x 6219819	6x 370921	1x 6352686	2x 6411332
6x 6178921	2x 6258973	2x 6173961	2x 6385920	6x 6244918	1x 4160868	2x 302224
2x 6383982	2x 407021	2x 6275178	2x 6209519			
2x 6070698						

4

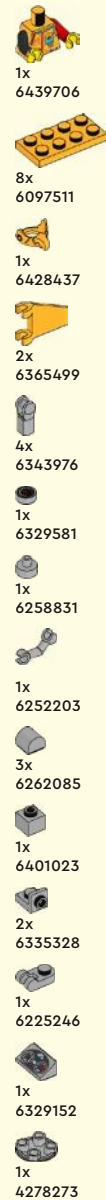
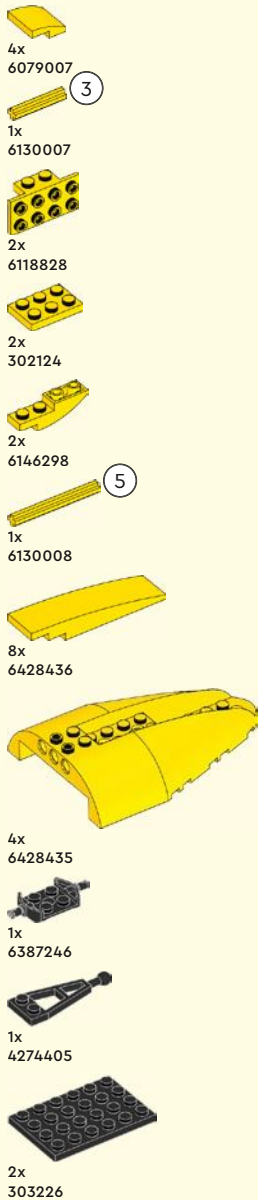

4x  
6326748

4x  
4529241

2x  
6254807

1x  
6129340

2x  
6116608

2x

4x  
4211705

2x  
6352224

1x  
6411365

4x  
4595710

4x

1x  
6258887

1x  
4567887

2x  
4249139

1x  
6115080

2x  
4210762

4x  
4540386

2x  
4211039

1x  
6117972

1x  
4211060

4x  
6236949

2x  
6047417

1x  
6172811

1x  
4227398

4x  
6296856

6x  
6100030

5x  
6395635

4x  
6360675

2x  
6360111

2x  
6321350

1x  
6364352

2x  
6221607

1x  
6290401

1x  
6003147

1x  
6274711

1x  
6252838

3x  
6190252

1x  
6345878

1x  
6109685

3x  
6345949

1x  
6369006

2x  
6093573

1x

1x  
6410229

4x  
6218360

1x  
6417774

1x  
6435640

1x  
6102994

1x  
6143217

1x  
6417770

1x  
6428990

2x  
6214235

1x  
6366633

1x  
6417775

1x  
6261503

1x  
6439675

1x  
4611883

 [LEGO.com/service](https://www.LEGO.com/service)



**YOU COULD WIN**



Scan this QR code or go to **LEGO.COM/PRODUCTFEEDBACK** and give us your short feedback about this LEGO® set for a chance to win a cool LEGO prize.

Terms and Conditions apply\*

**EN: YOU COULD WIN.** Terms and Conditions apply\* **DE: Du könntest GEWINNEN.** Es gelten die Teilnahmebedingungen\* **FR: Tu pourrais GAGNER.** Des conditions s'appliquent\* **IT: Potresti VINCERE tu.** Termini e condizioni sono applicabili\* **ES: Puedes GANAR.** Aplican términos y condiciones\* **PT: Poderá GANHAR.** Aplicam-se termos e condições\* **ZH: 轻松获奖. 条款和条件适用\*** **PL: Szansa na WYGRANĄ.** Obowiązują warunki korzystania\* **CS: Máte šanci VYHRÁT.** Platí všeobecné smluvní podmínky\* **SK: Máte šancu VYHRÁŤ.** Platia všeobecné zmluvné podmienky\* **HU: TE IS NYERHETSZ.** Felhasználási feltételek érvényesek\* **RO: Ai putea CÂȘTIGA.** Se aplică termenii și condițiile\* **BG: Можете да СПЕЧЕЛИТЕ.** Има определени правила и условия\* **LV: Tu vari LAIMĒT.** Ir spēkā noteikumi un nosacījumi.\* **ET: Sul on võimalus VÕITA.** Kehtivad tingimused\* **LT: Jūs galite LAIMĖTI.** Tai l omos sąlygos\*

\*[LEGO.com/productfeedback-terms](https://www.lego.com/productfeedback-terms)

LEGO and the LEGO logo are trademarks of the/son des marques de commerce du/son marcas registradas de LEGO Group. ©2023 The LEGO Group.