



Architecture

21034
London
Great Britain



London

Originally founded by the Romans over 2,000 years ago, London has grown to become the cultural and economic capital of Britain and one of the world's truly global cities.

Famous for its finance, fashion and arts industries, London is the world's most visited city and also one of its most

culturally diverse; more than 300 languages are spoken by its population of over 8.5 million people.

Standing on the River Thames, London's skyline reflects both the city's diverse and colorful past and its continued ambition to embrace bold, modern architectural statements.

*["When a man is tired of London, he is tired of life;
for there is in London all that life can afford."]*

Samuel Johnson



The National Gallery

From the very start, the aim of the National Gallery was to ensure that the widest public possible could enjoy its collection. When Parliament agreed to pay for the construction of a new gallery in 1831, there were lengthy discussions about where the building should be located. Trafalgar Square was eventually chosen, as it was considered to be at the very center of the city and therefore accessible by all classes of London society. Construction began in 1832 and the new gallery was finally completed in 1838.

The building has been enlarged and altered many times as the National Gallery's collection grew and today holds over 2,300 works of art. Over six million people visit the Gallery every year to enjoy works by Leonardo da Vinci, Vincent Van Gogh and J.M.W. Turner.







Nelson's Column



The 169 ft. (51.6 m) column stands in front of the National Gallery in Trafalgar Square and was erected between 1840 and 1843 to commemorate the British naval hero Admiral Horatio Nelson, who died at the Battle of Trafalgar in 1805.

The pedestal upon which the column stands is decorated with four bronze reliefs; each one is 18 ft. (5.5 m) square and cast from captured French guns.

Big Ben



Big Ben (the Great Bell), officially known as the Elizabeth Tower (formerly known as the Clock Tower and renamed in 2012 in honor of Queen Elizabeth's Diamond Jubilee), has stood at the northeastern corner of the Palace of Westminster for over 150 years. The 316 ft. (96.3 m) neo-gothic styled tower is one of the most recognized and photographed landmarks in London today and an integral part of the city's skyline. The tower's clock mechanism is wound by hand three times a week and is still as accurate today as when it was constructed over 150 years ago.



London Eye

Opened in 2000 to mark the new millennium, the London Eye is still the world's largest cantilevered observation wheel. With a height of 443 ft. (135 m), this remarkable feat of design and engineering has become the UK's most popular paid attraction, with 3.75 million visitors every year. On a clear day it is possible to see up to 25 miles (40.2 km) in the distance from the top of the wheel.

Originally intended as a temporary structure, the London Eye is now a permanent fixture of the London skyline and an iconic symbol of modern London.







Tower Bridge

It took eight years and 11,000 tons of steel to construct the 213 ft. (65 m) tall Tower Bridge, and when it opened in June 1894 it was regarded as the most sophisticated bridge of its type in the world. The framework was clad in Cornish granite and Portland stone to protect the underlying steelwork, and to give the Bridge a more pleasing appearance. Built with giant moveable roadways that lift up for passing ships, it is still considered an engineering marvel and arguably remains the most recognized bridge in the world.

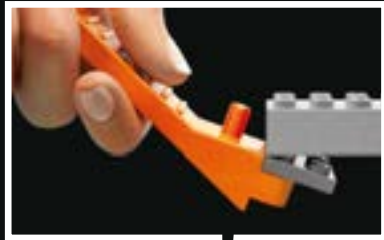

LEGO.com/brickseparator

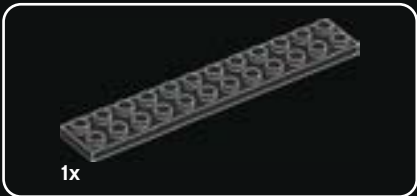
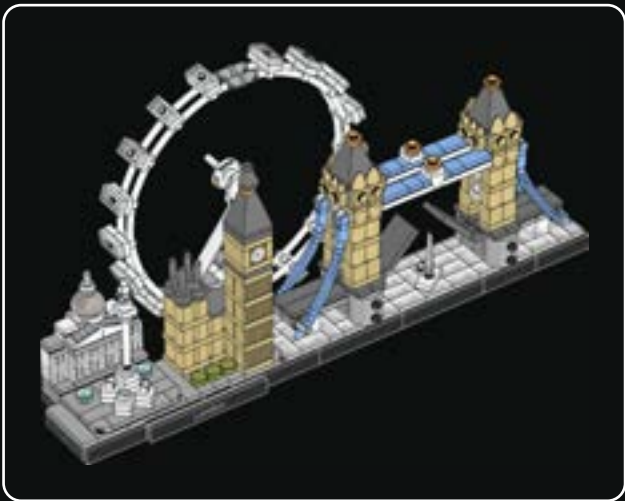

1x

1

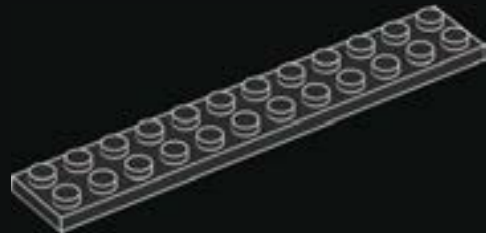



2

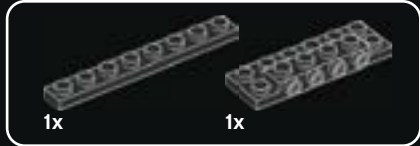
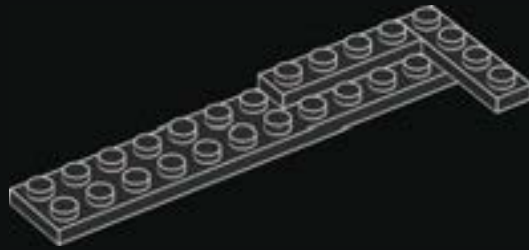

3

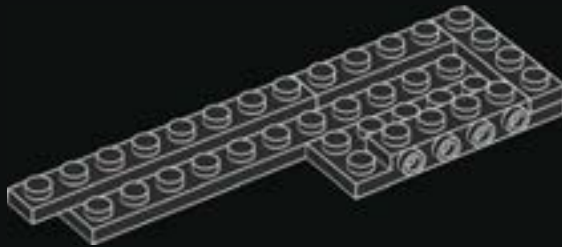



4

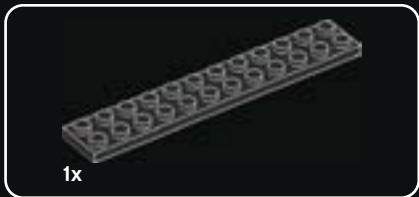
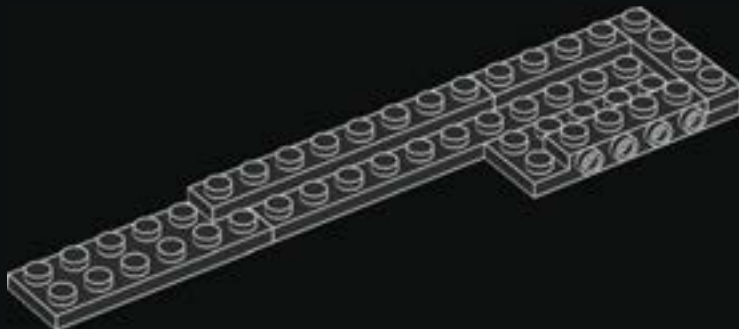

5

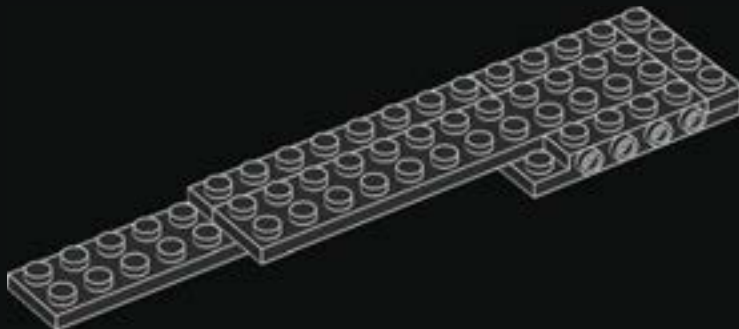



6

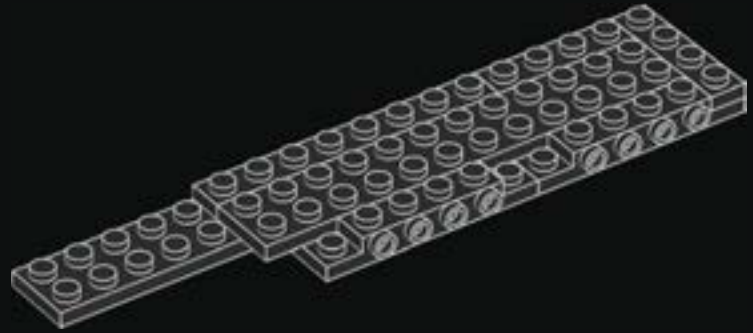

7

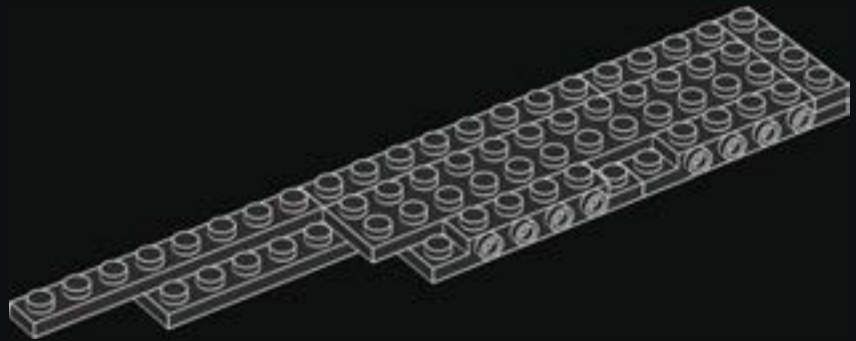



8

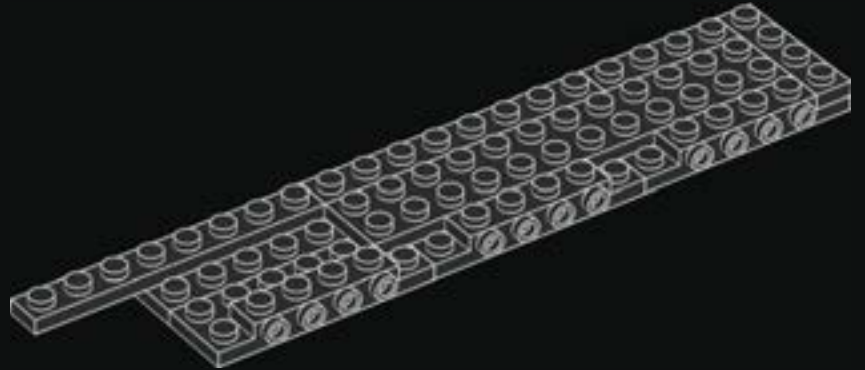

9

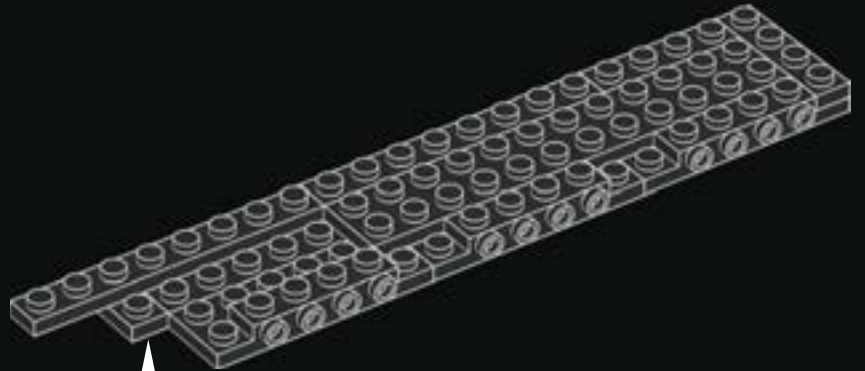

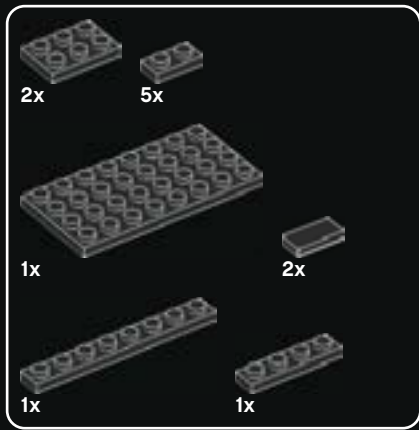

10

1



2



3

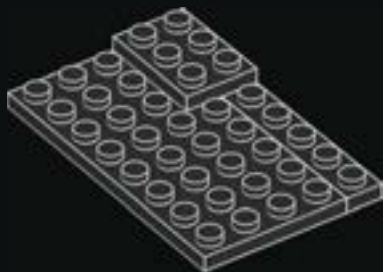

4

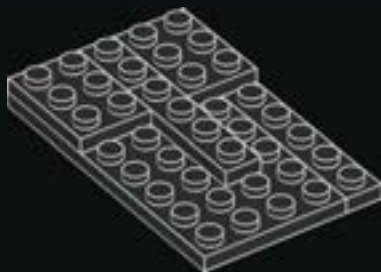

5

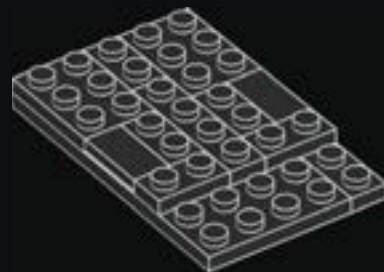

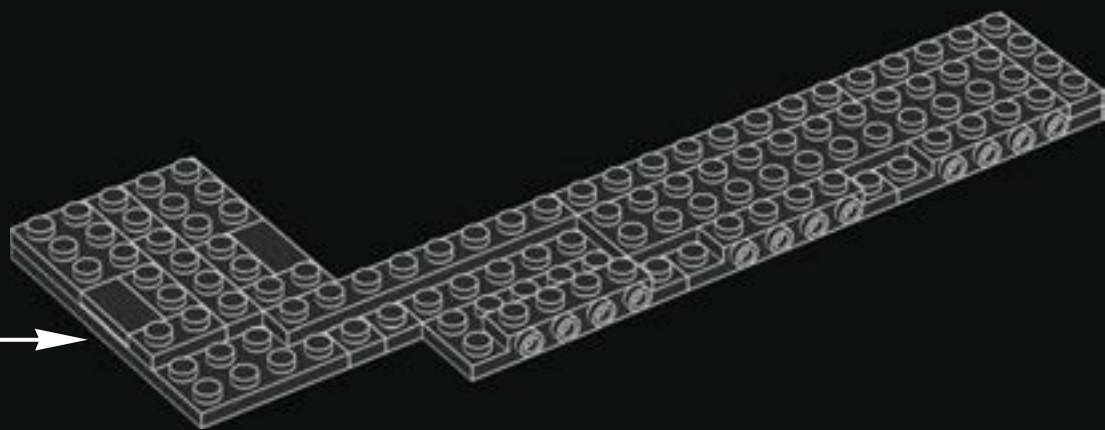

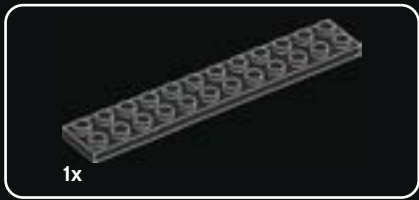

11

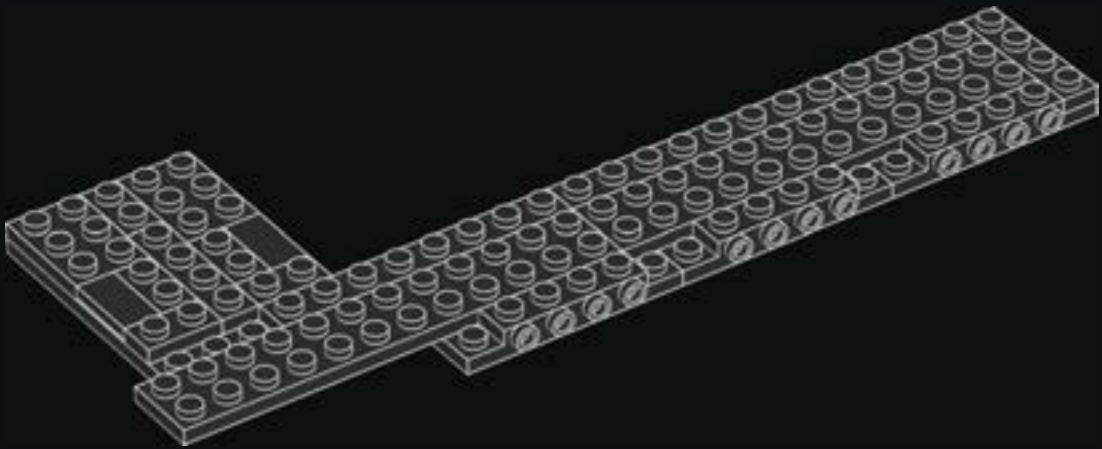



12

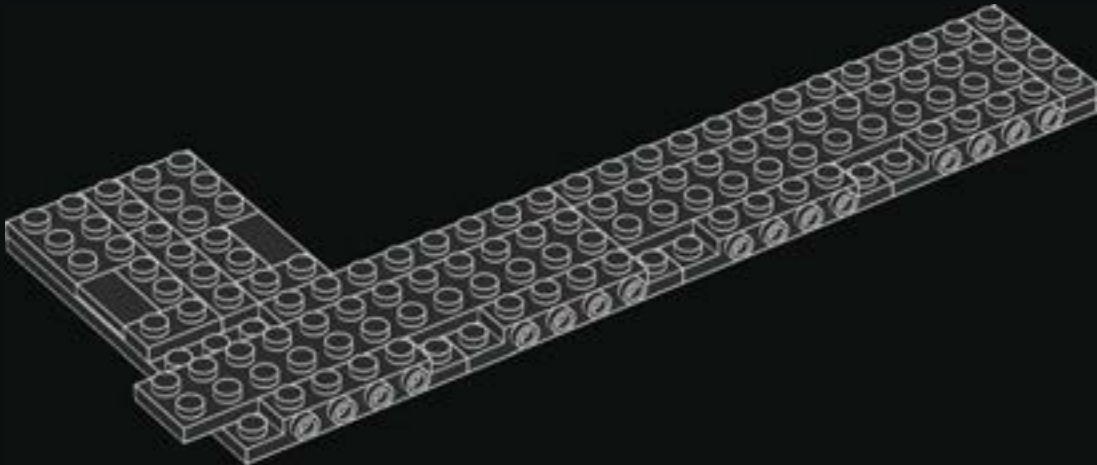



13

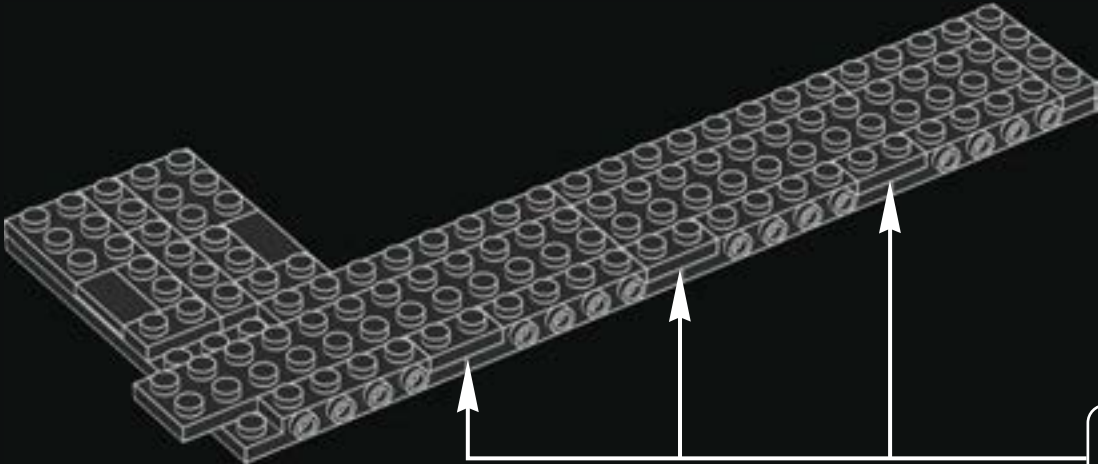

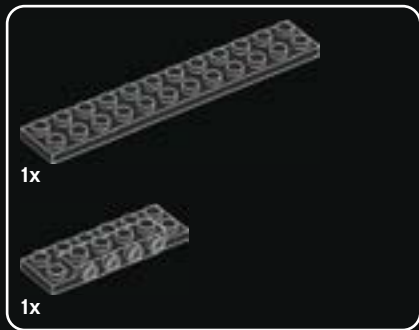

14

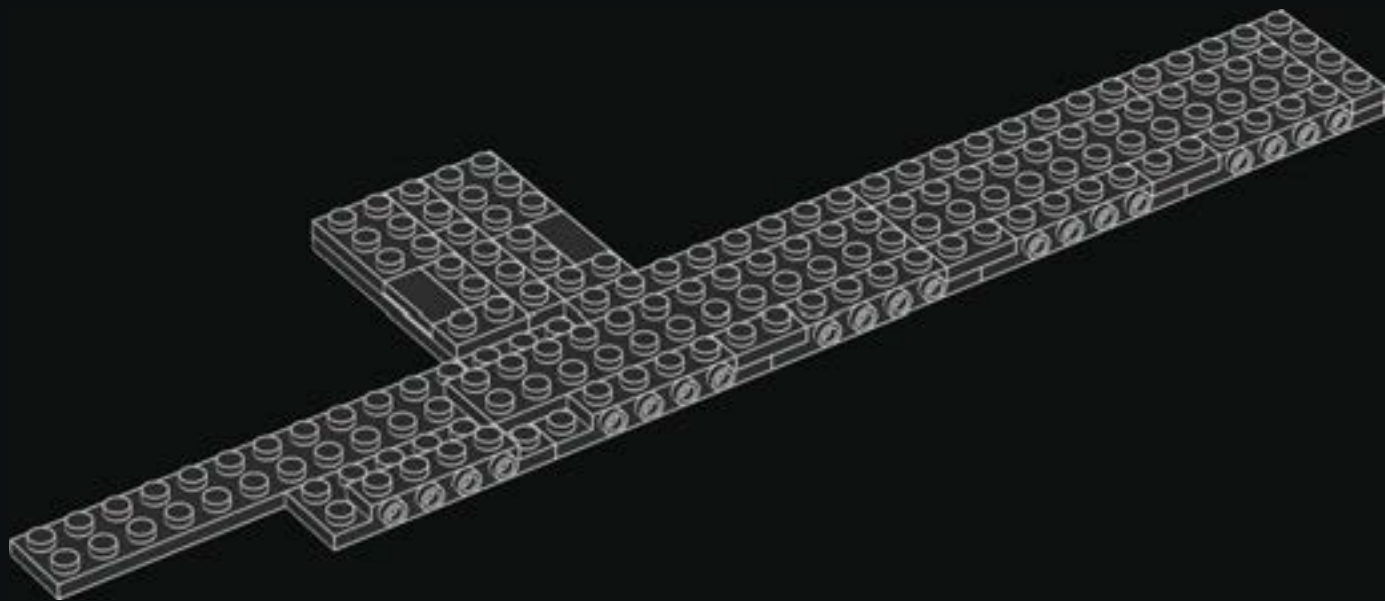



15

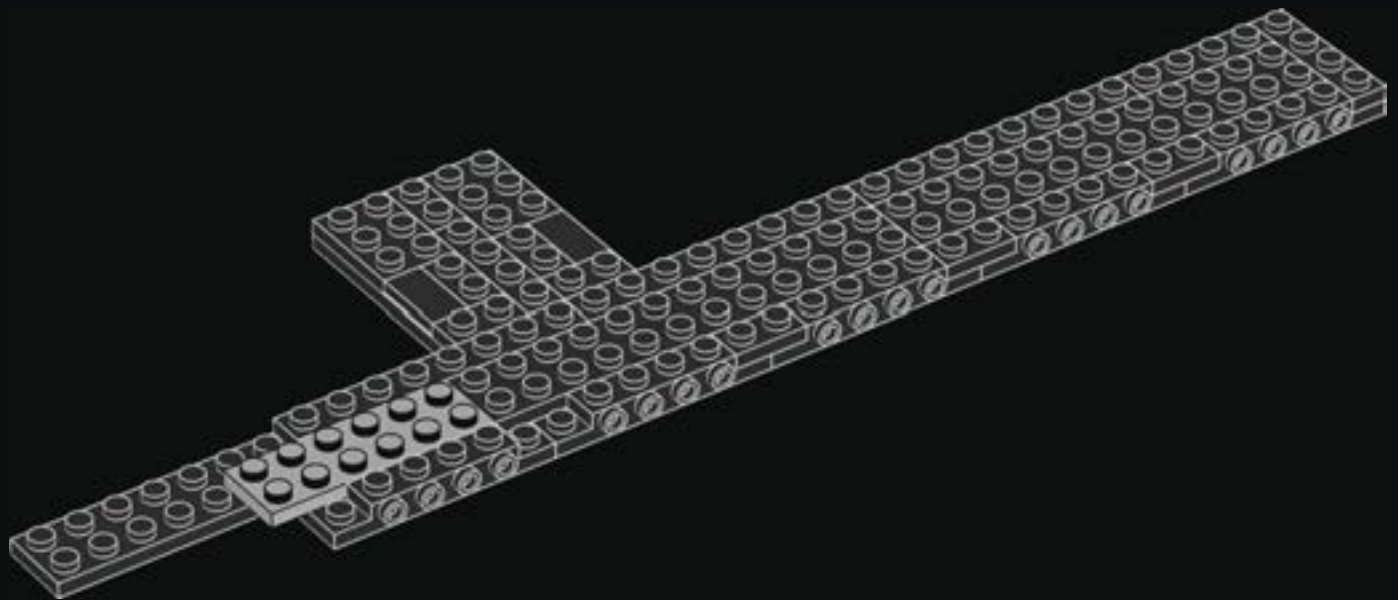



16

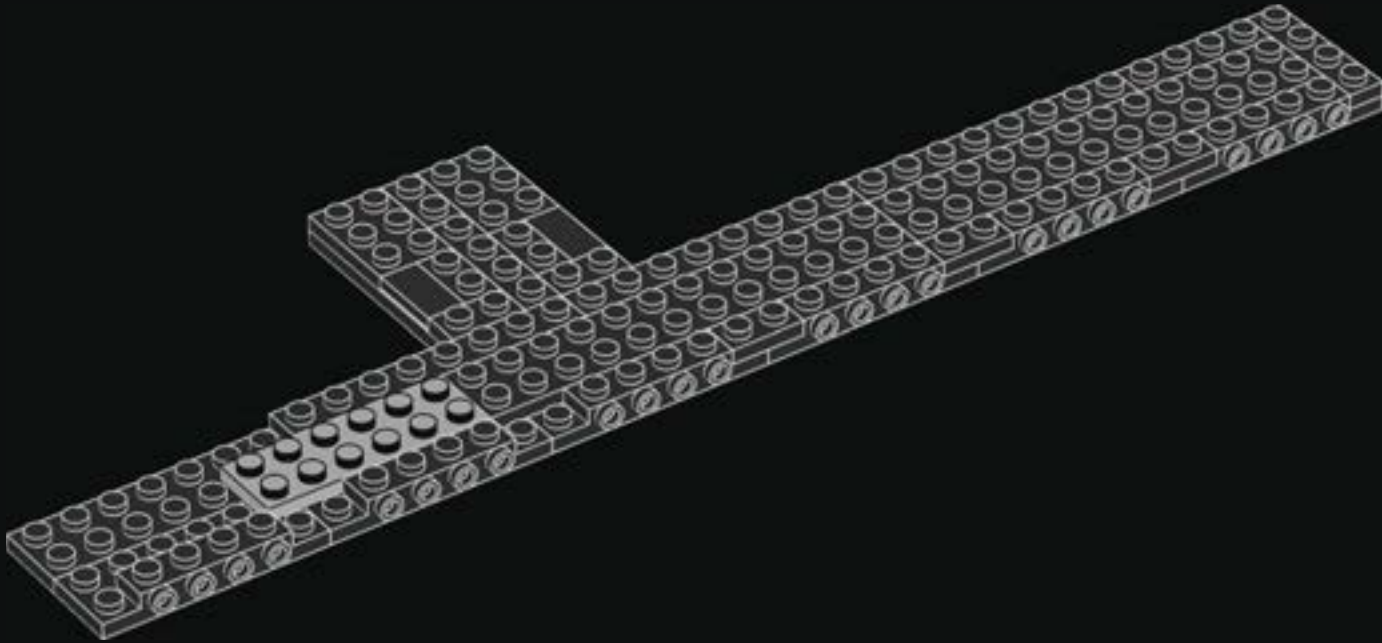

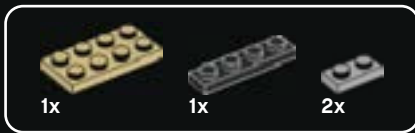

17

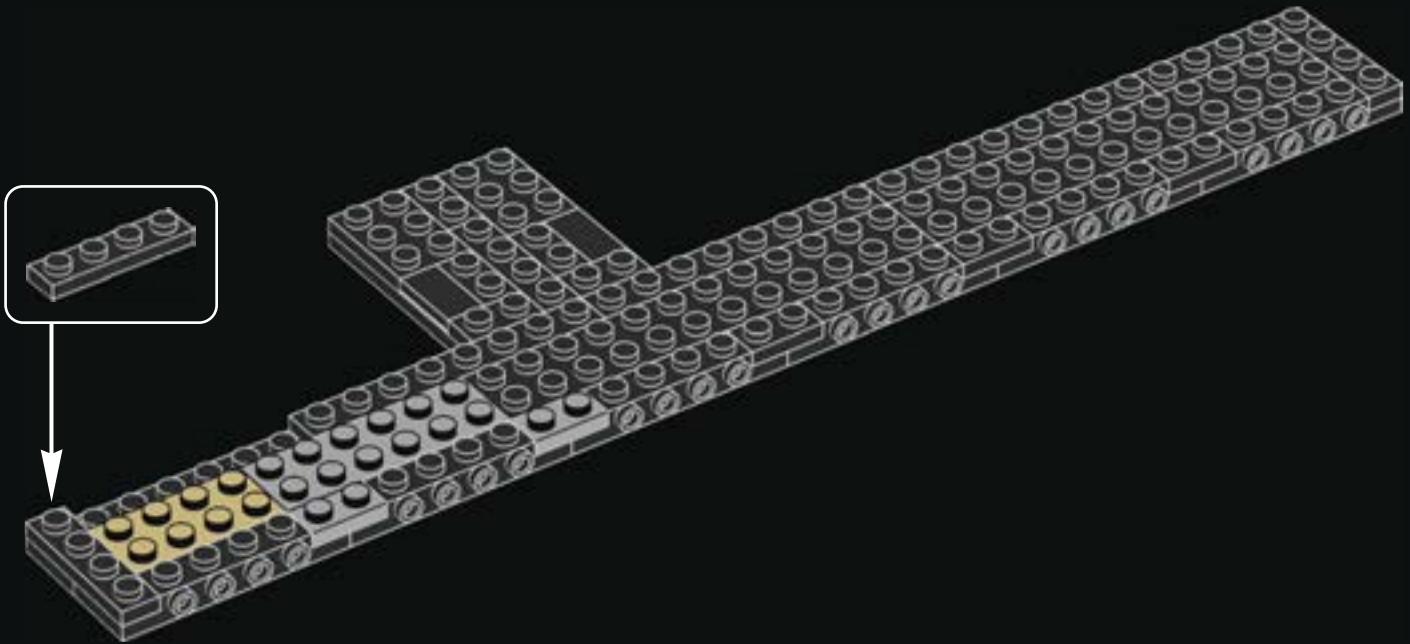

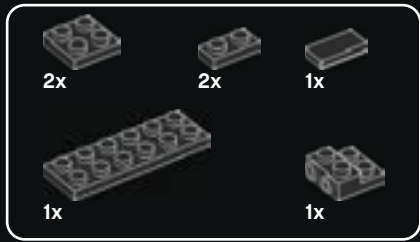

18

1



2

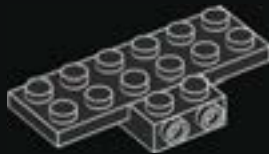

3

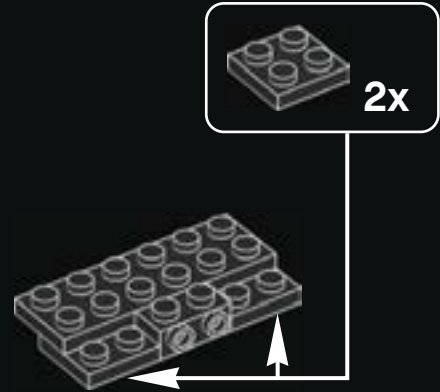

4

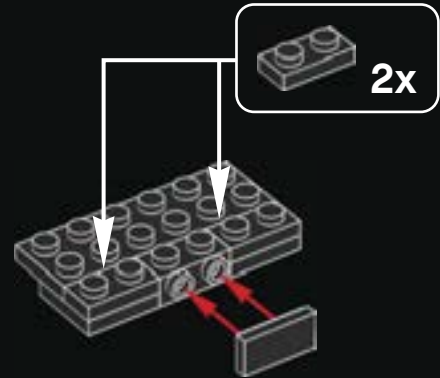

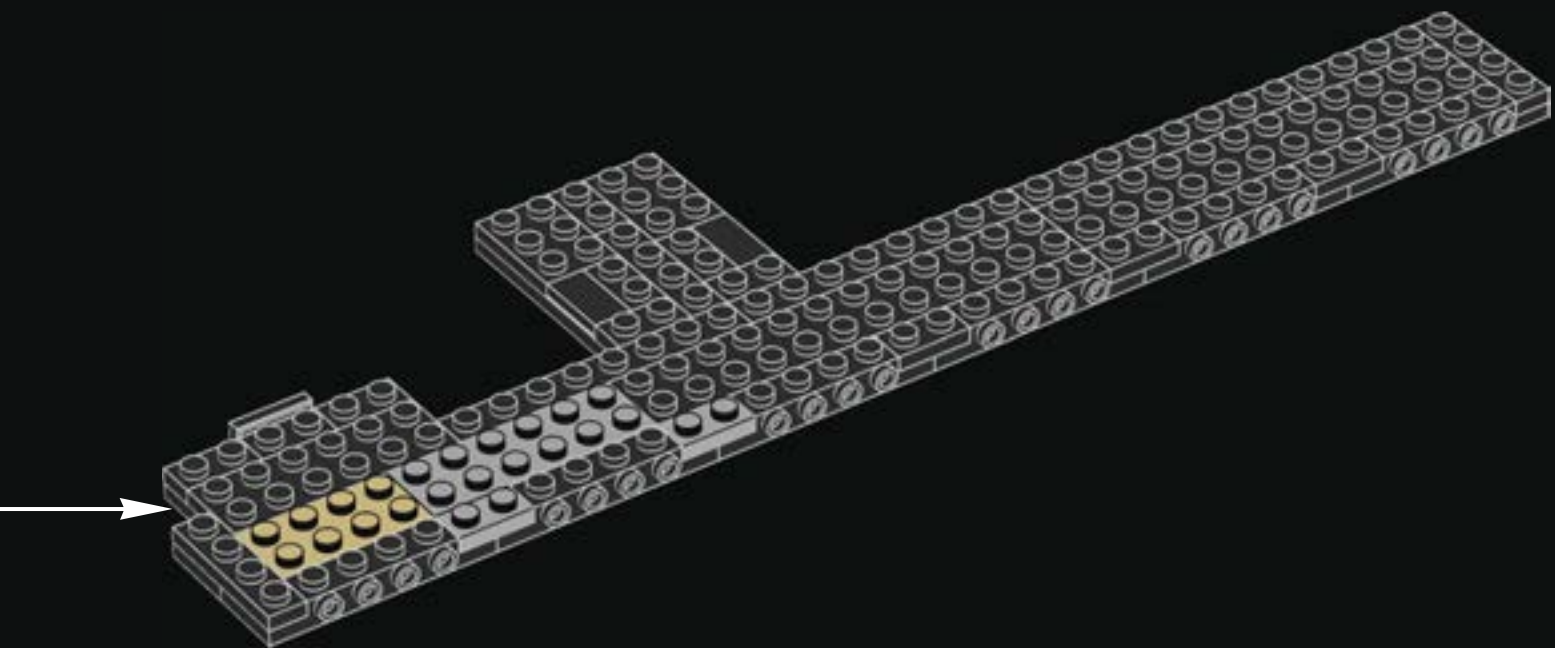



19

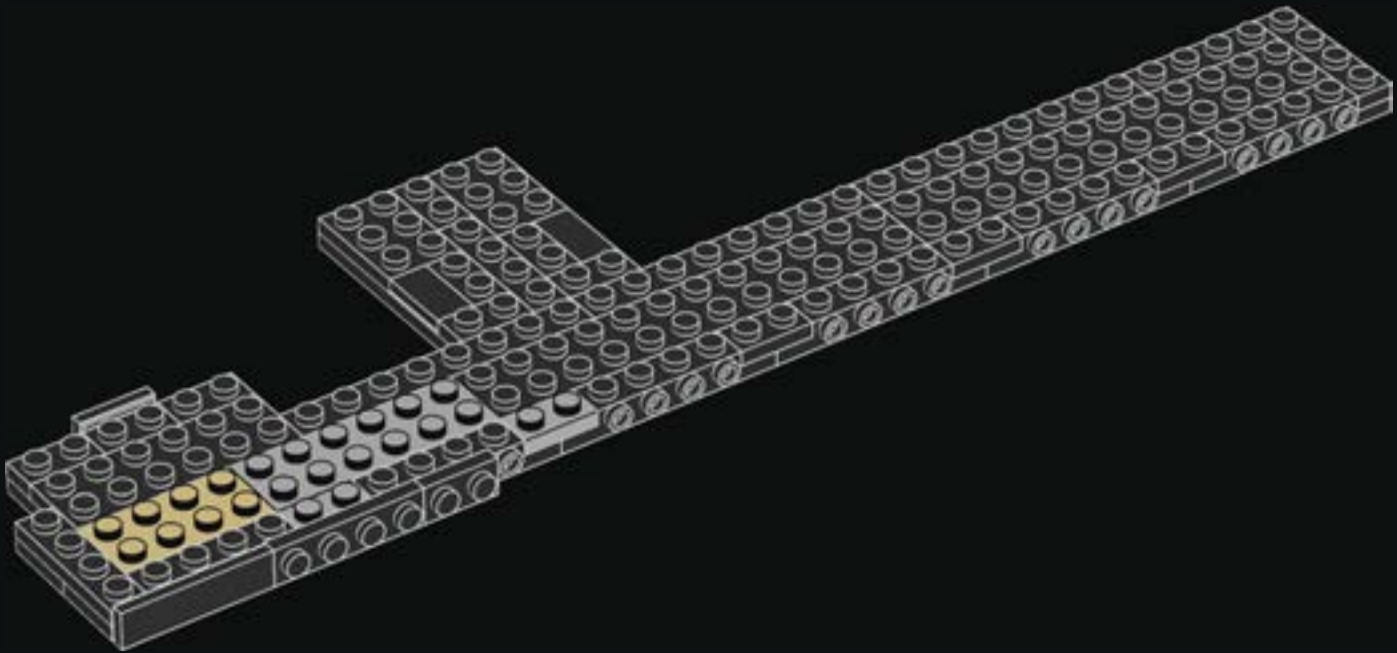

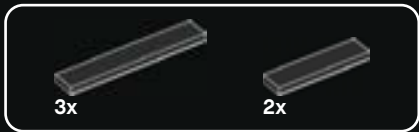

20

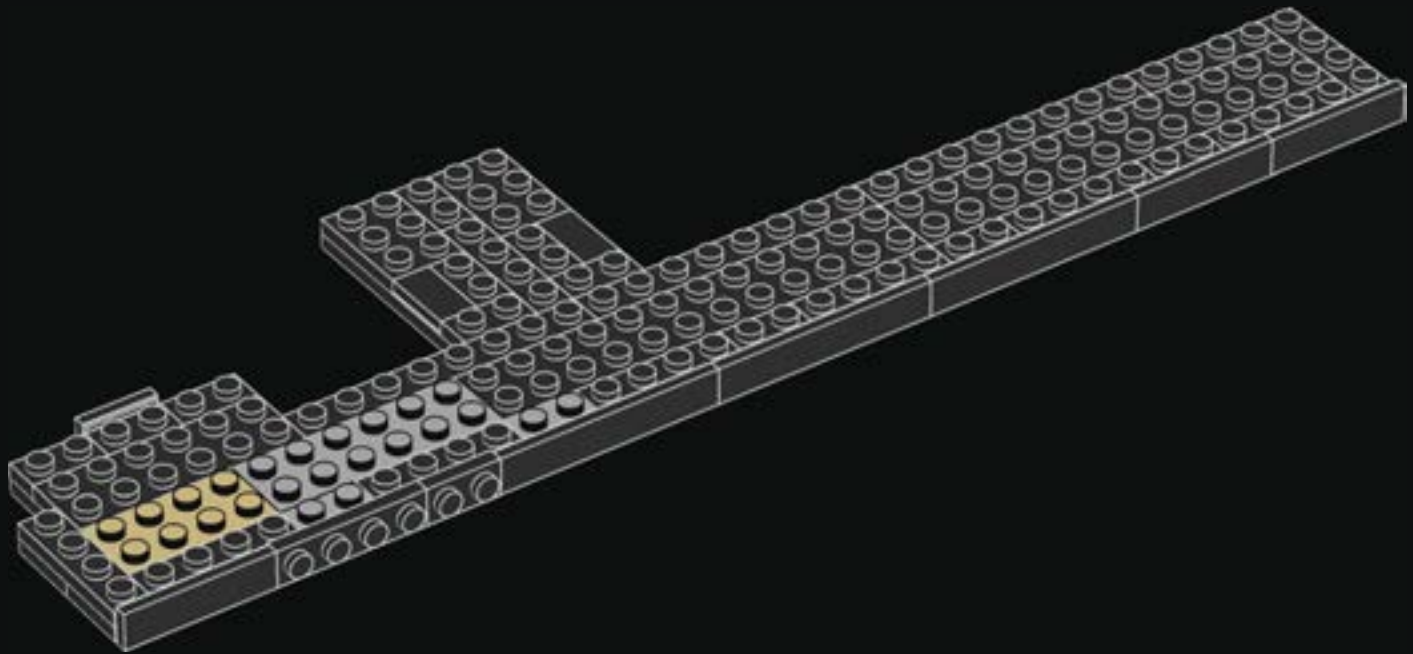



21

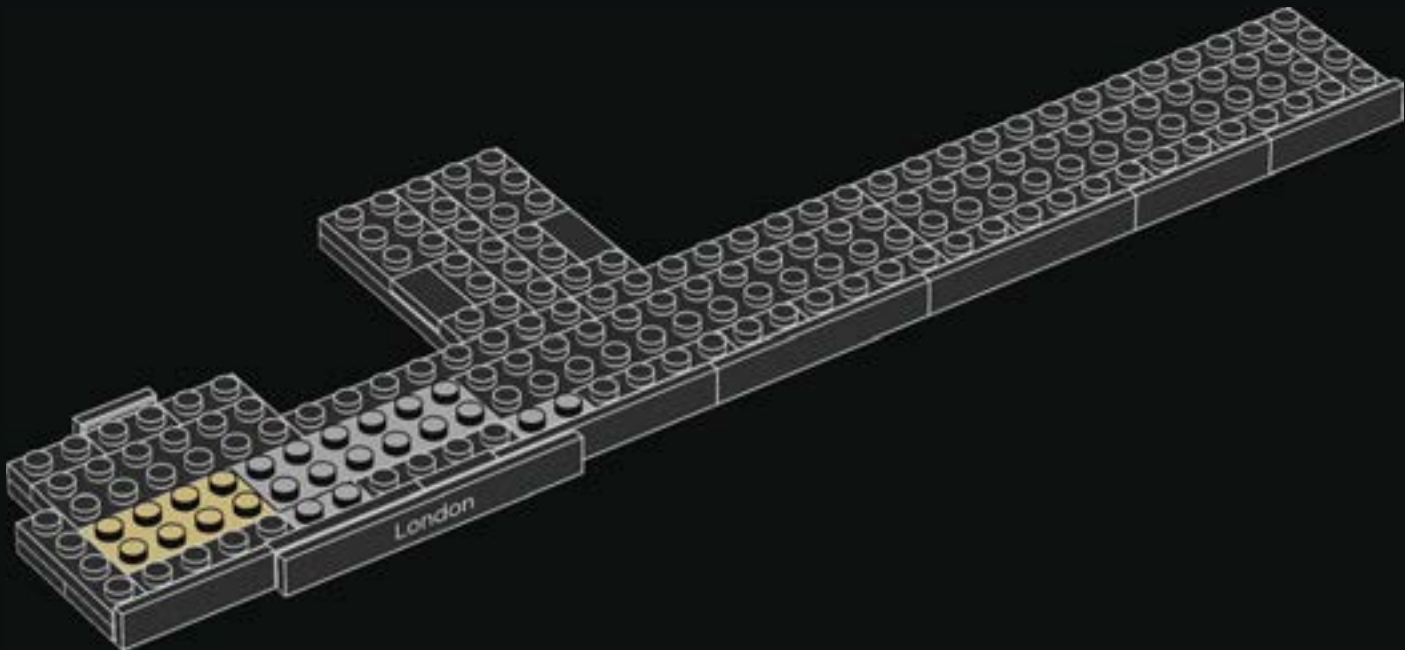

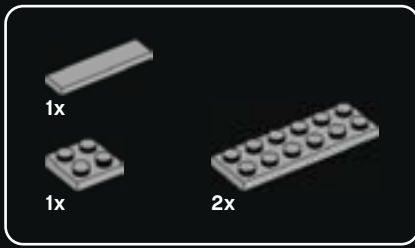

22

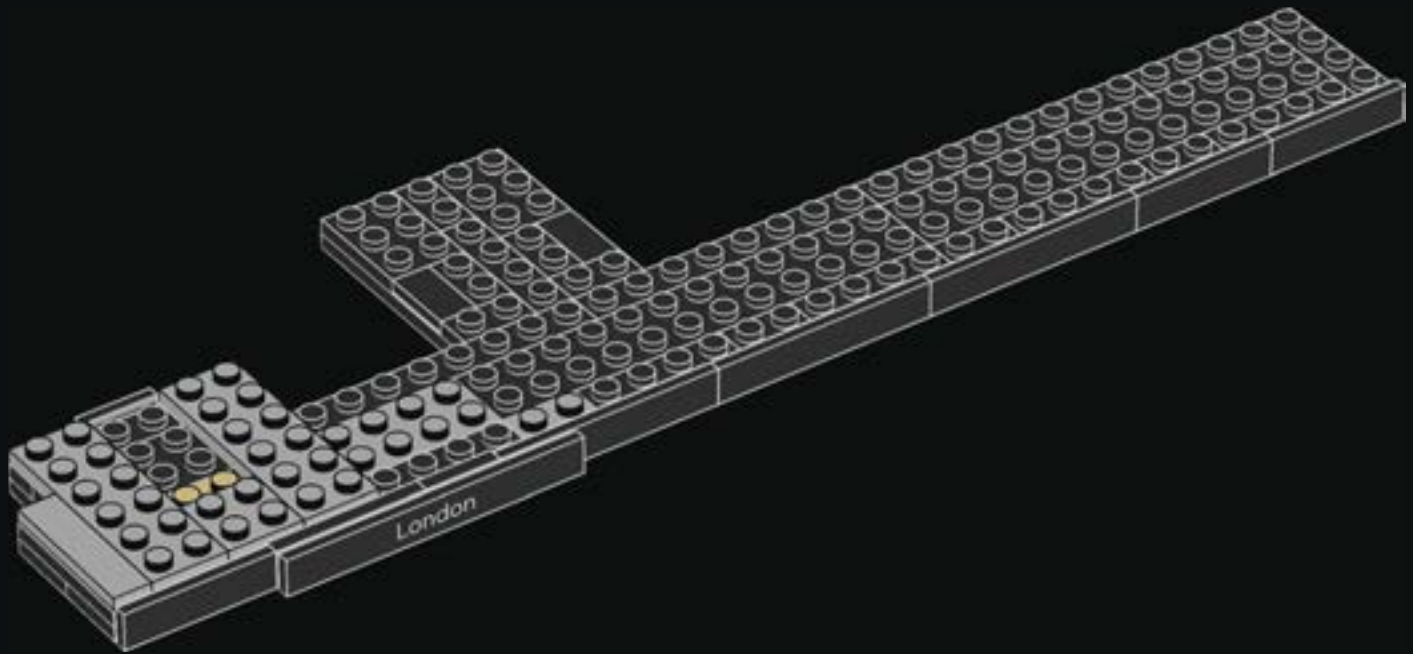

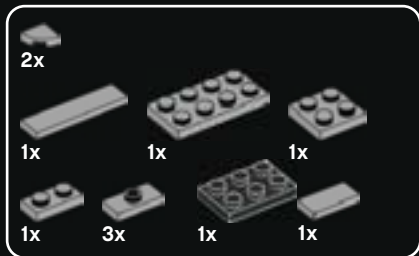

23

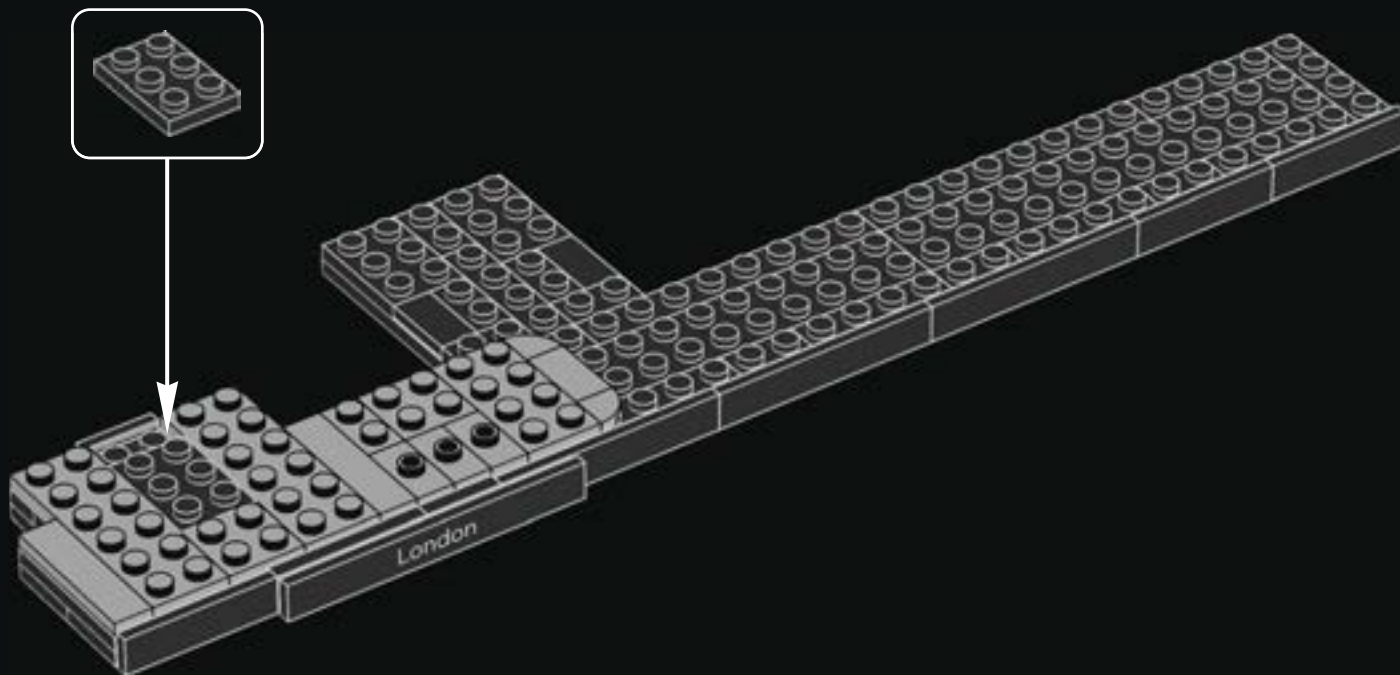



24

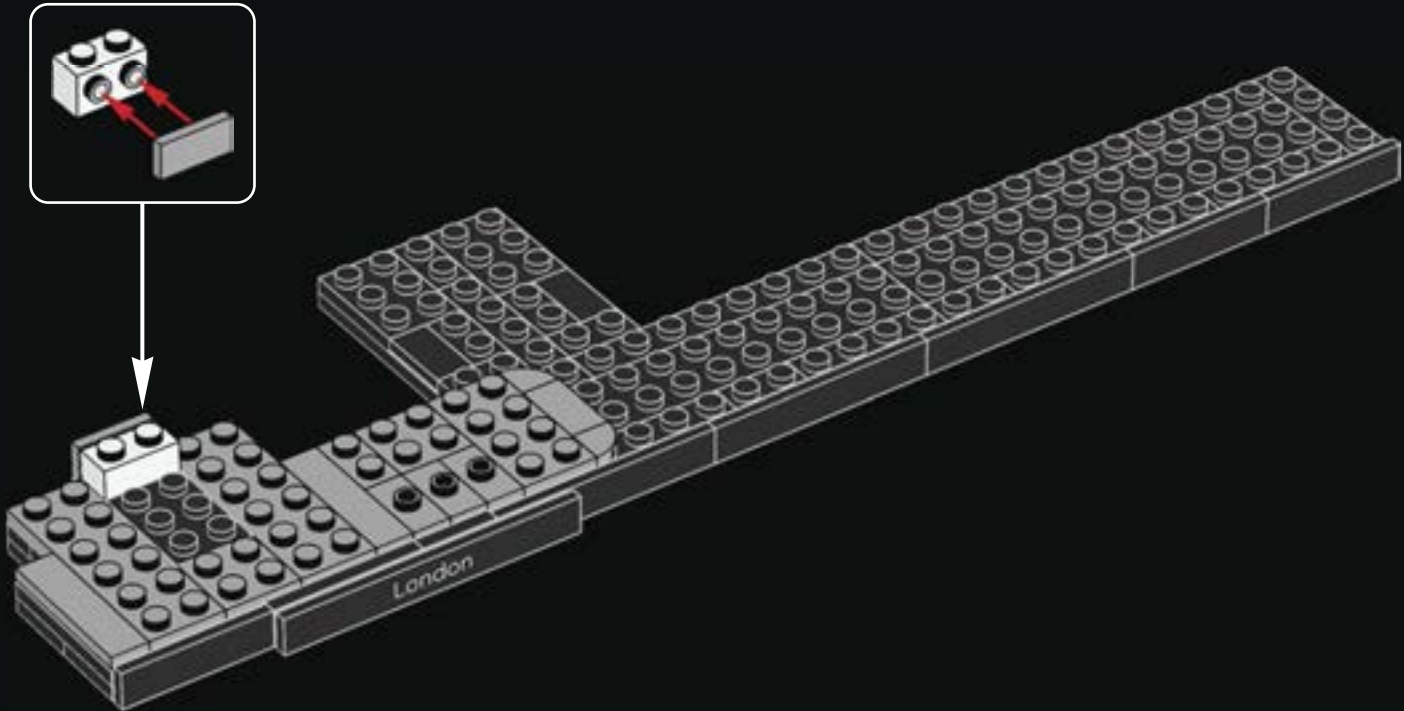

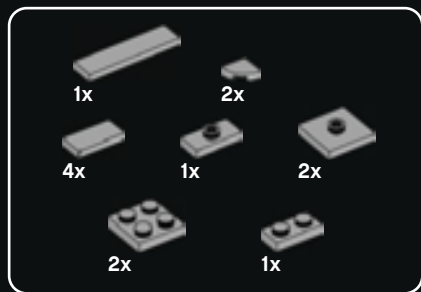

25

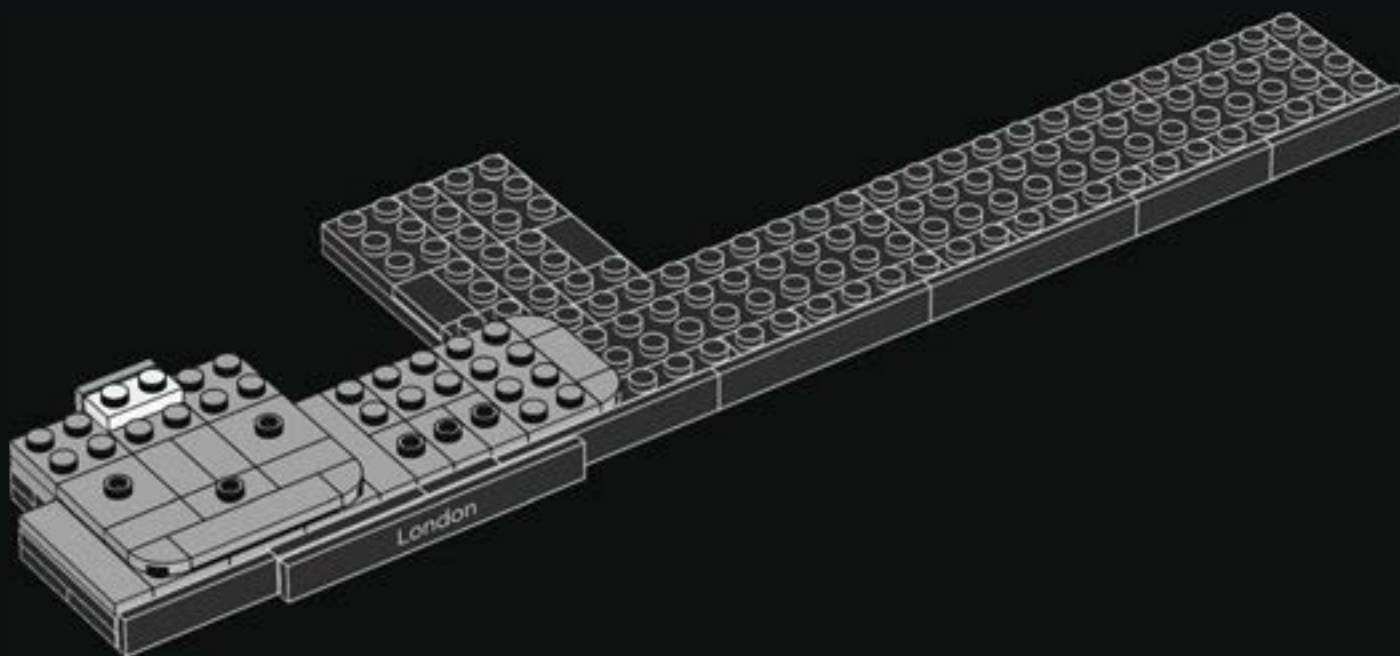



26

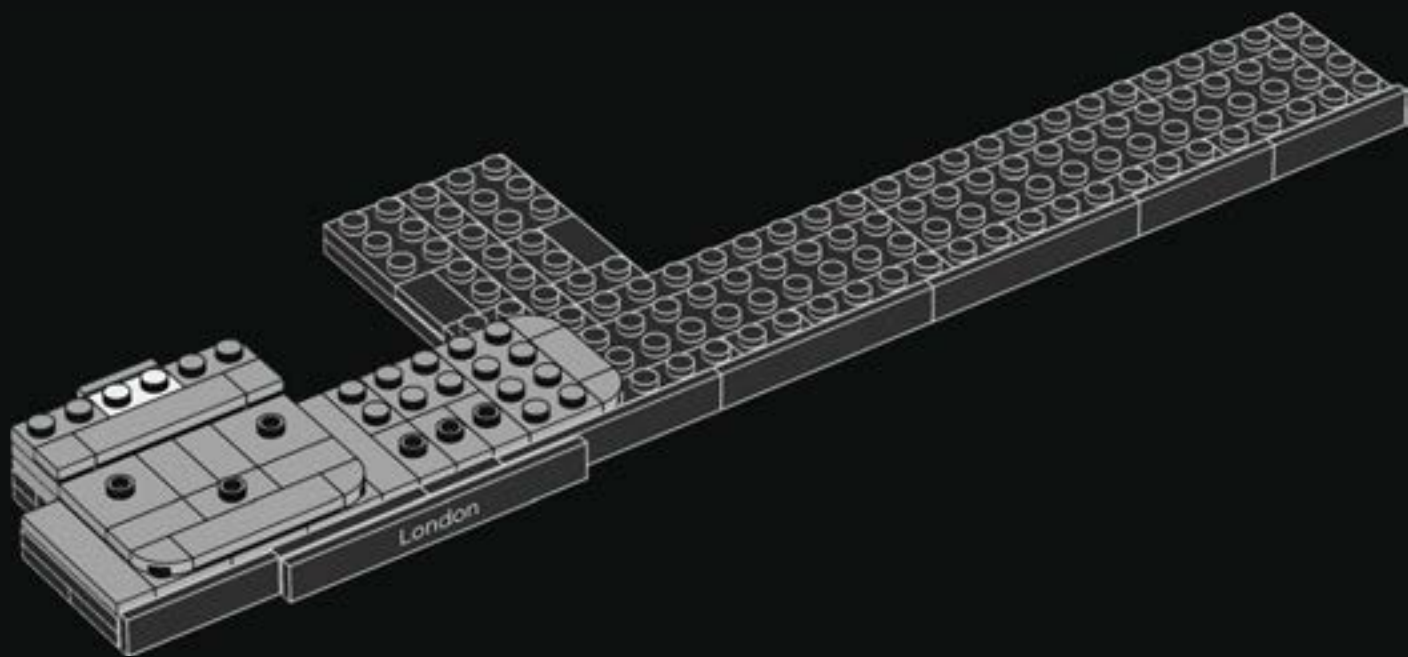

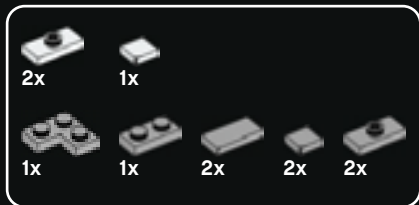

27

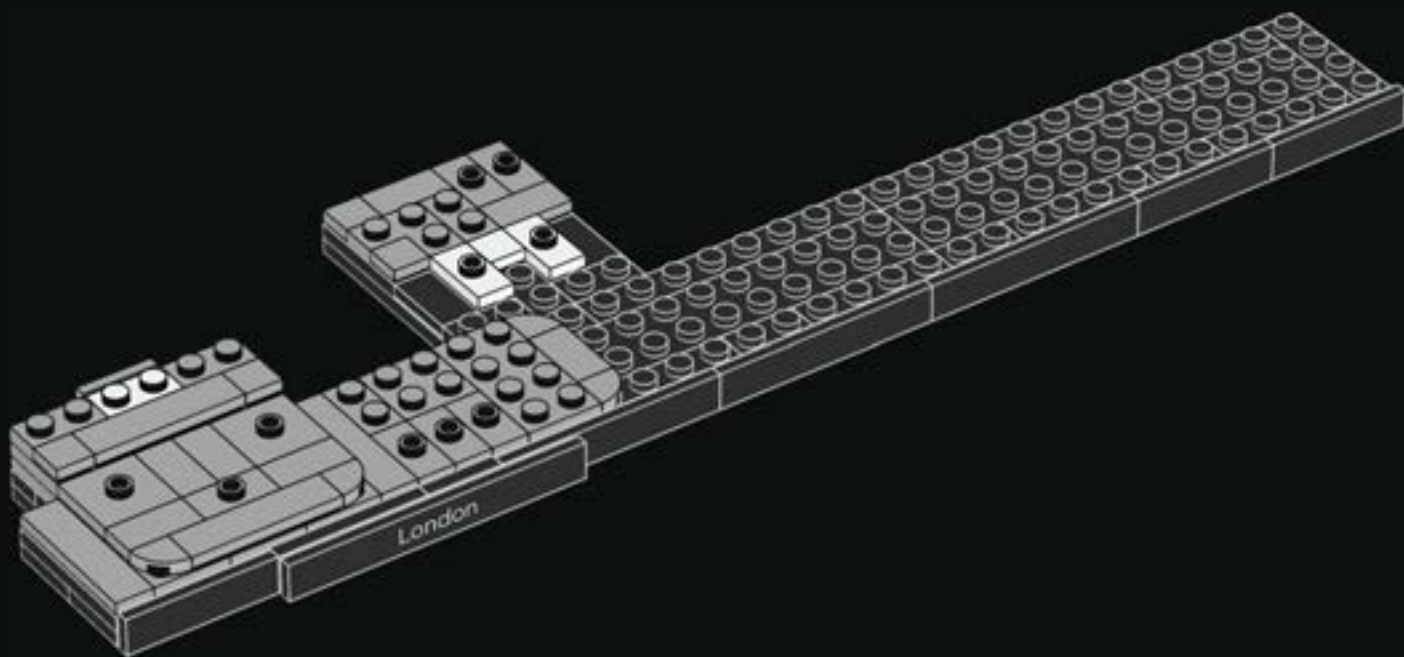

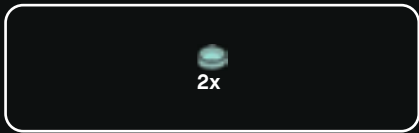

28

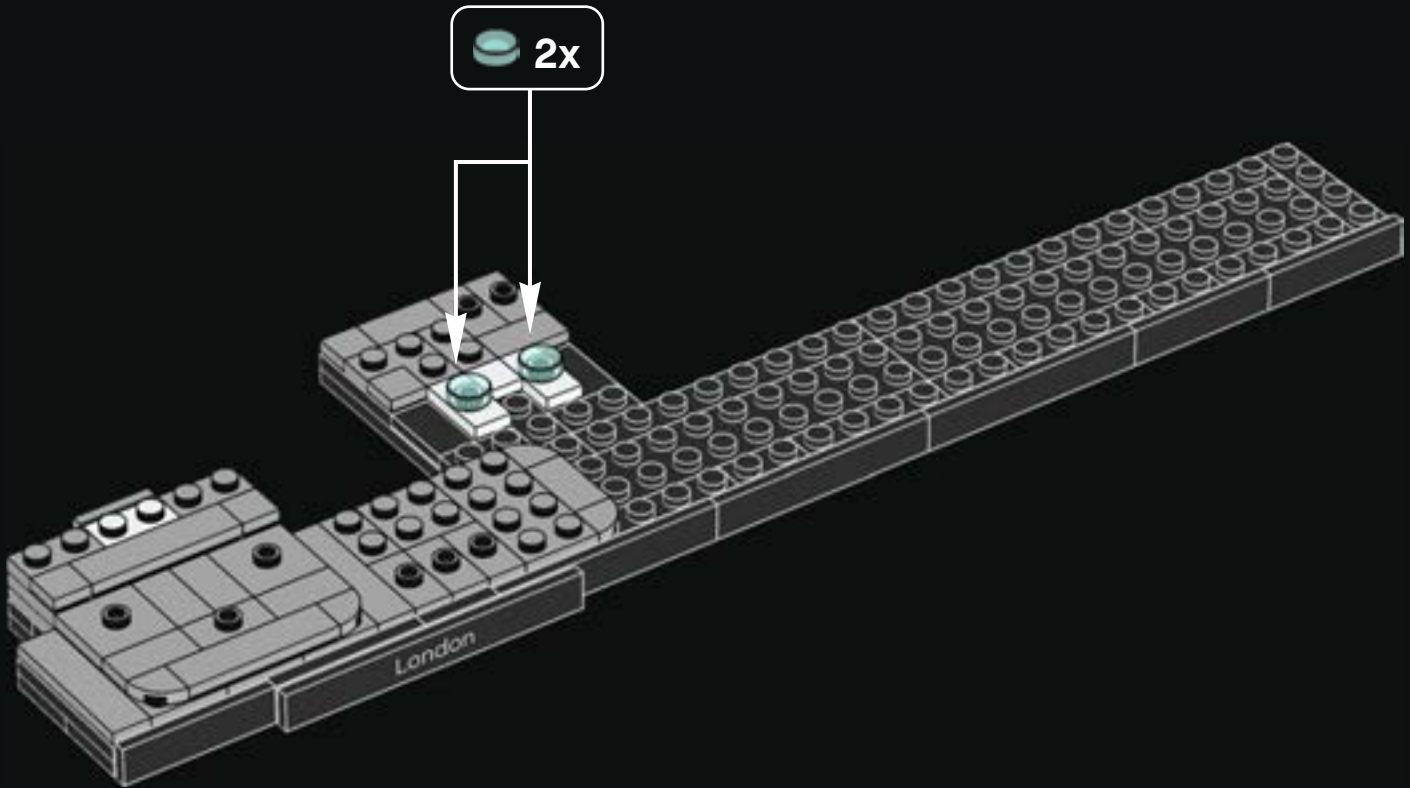



40x

29

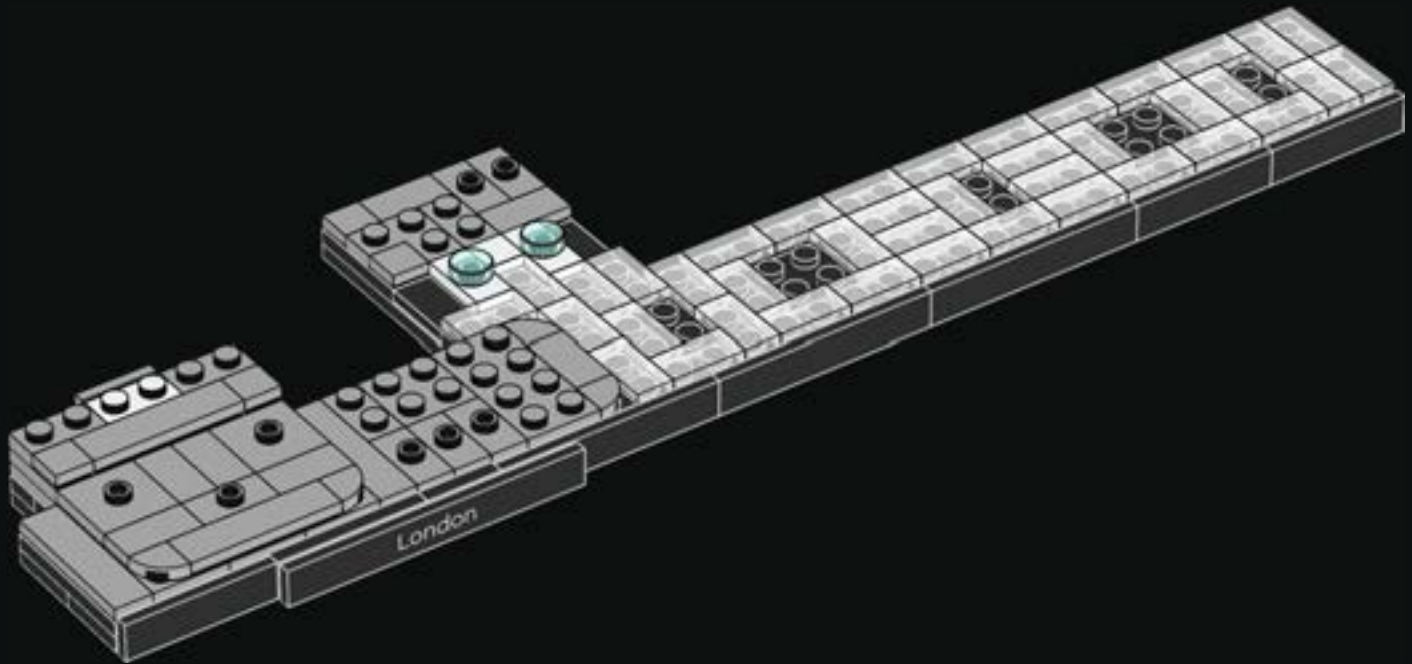

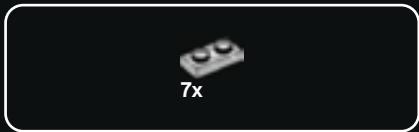

30

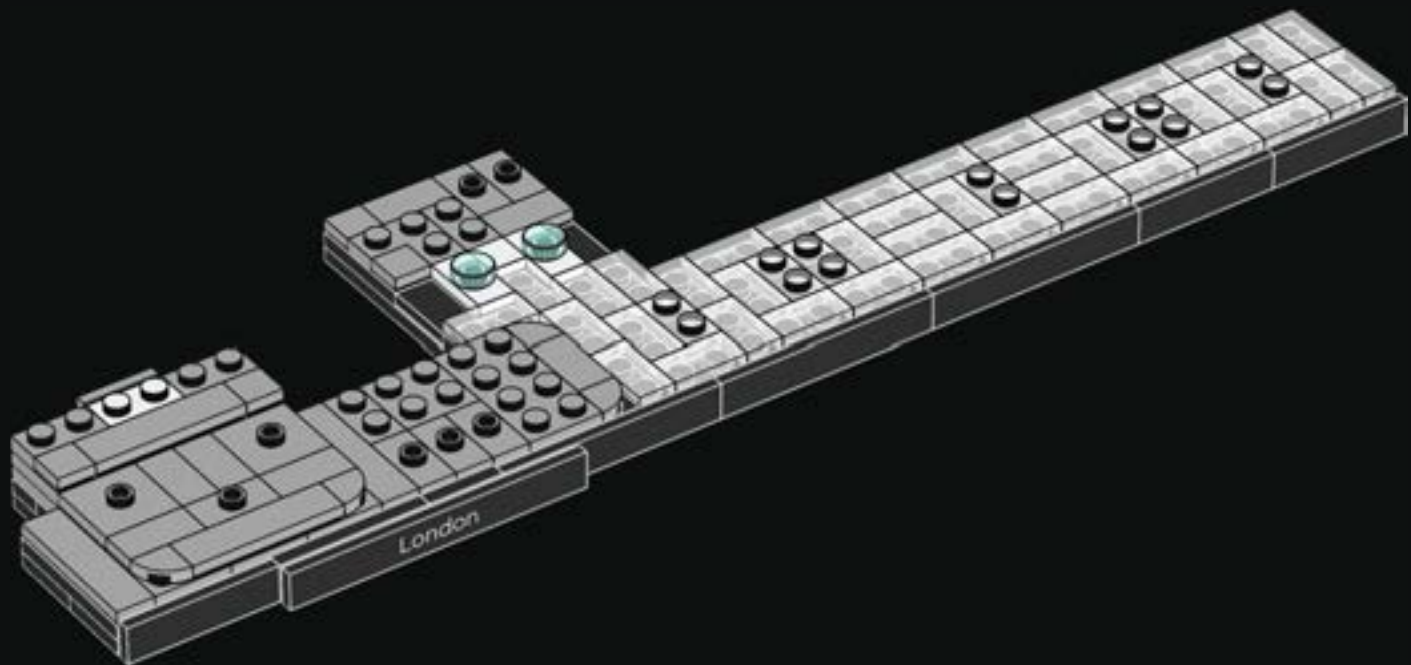



2x

31

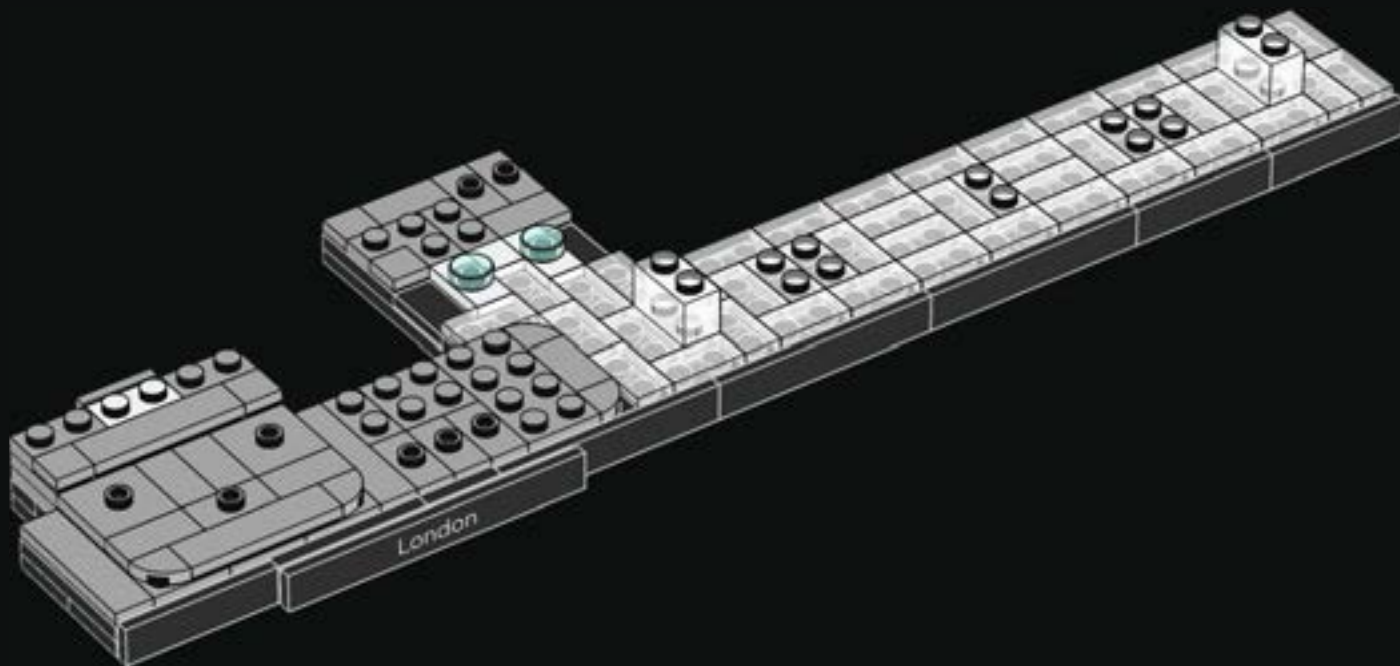



32

1



2



3



4

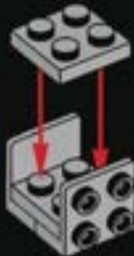

5



2x

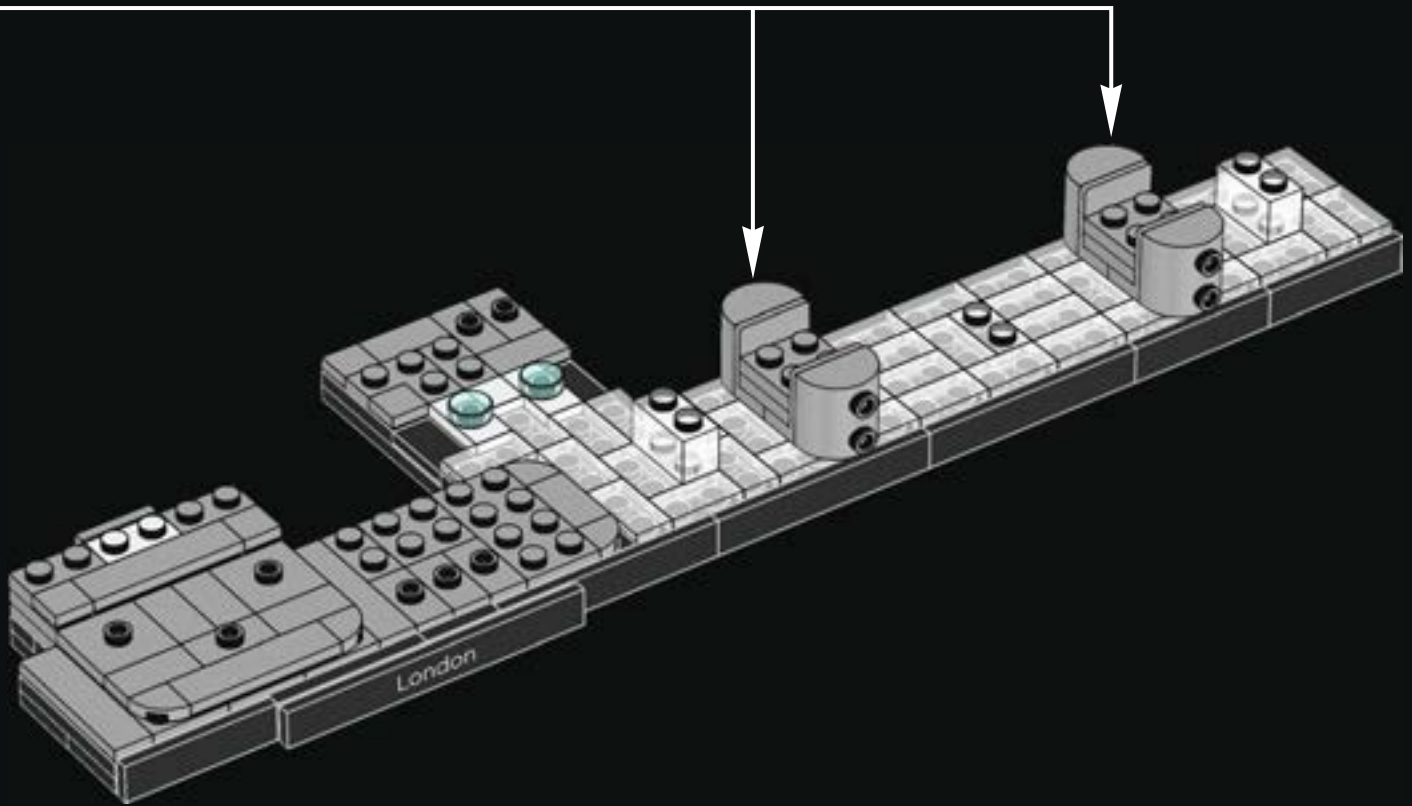

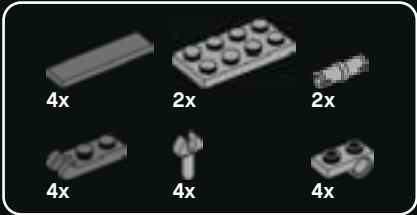

33

1



2



3



1



2



3



4

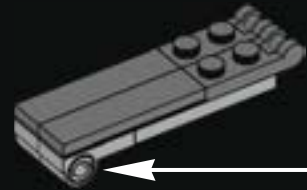

5

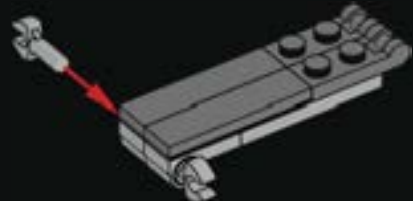

2x

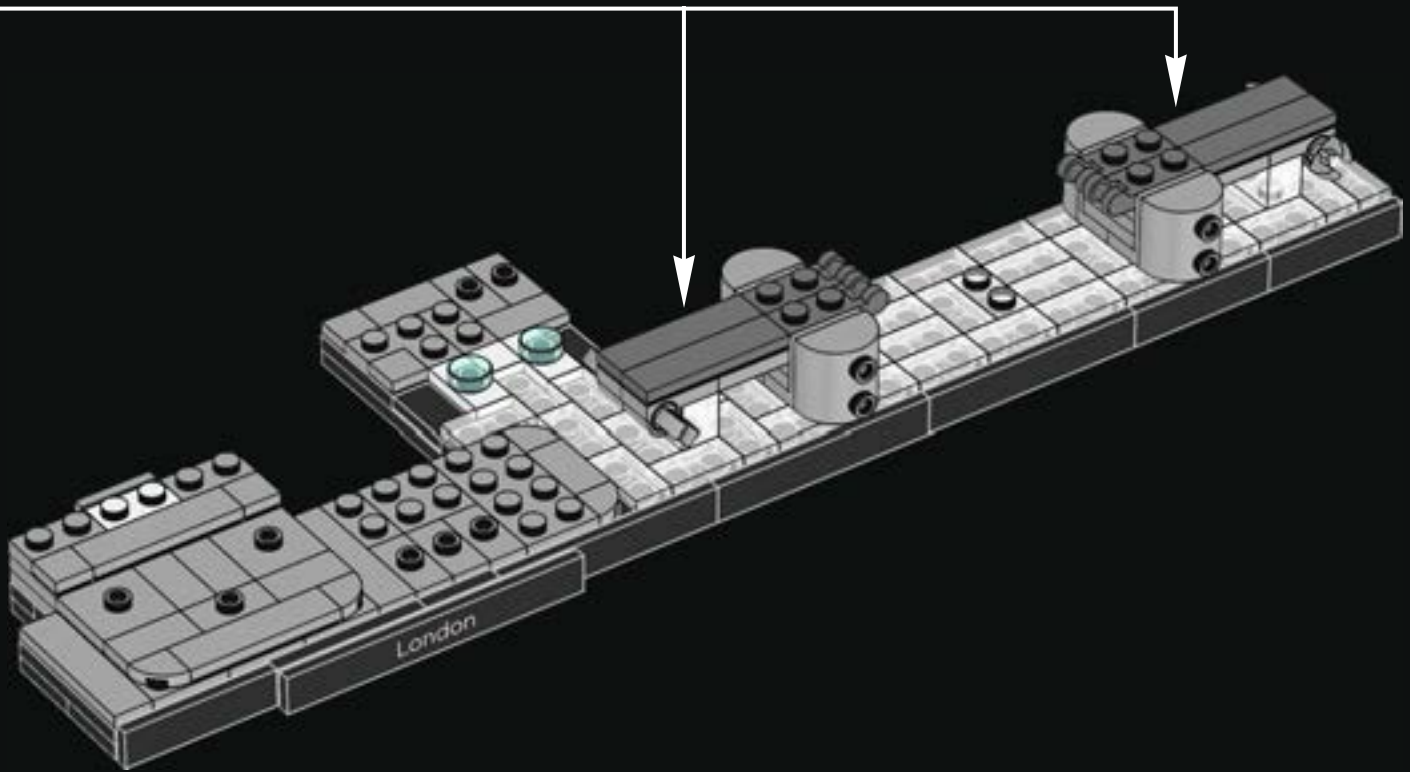

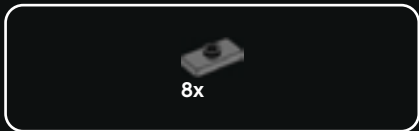

34

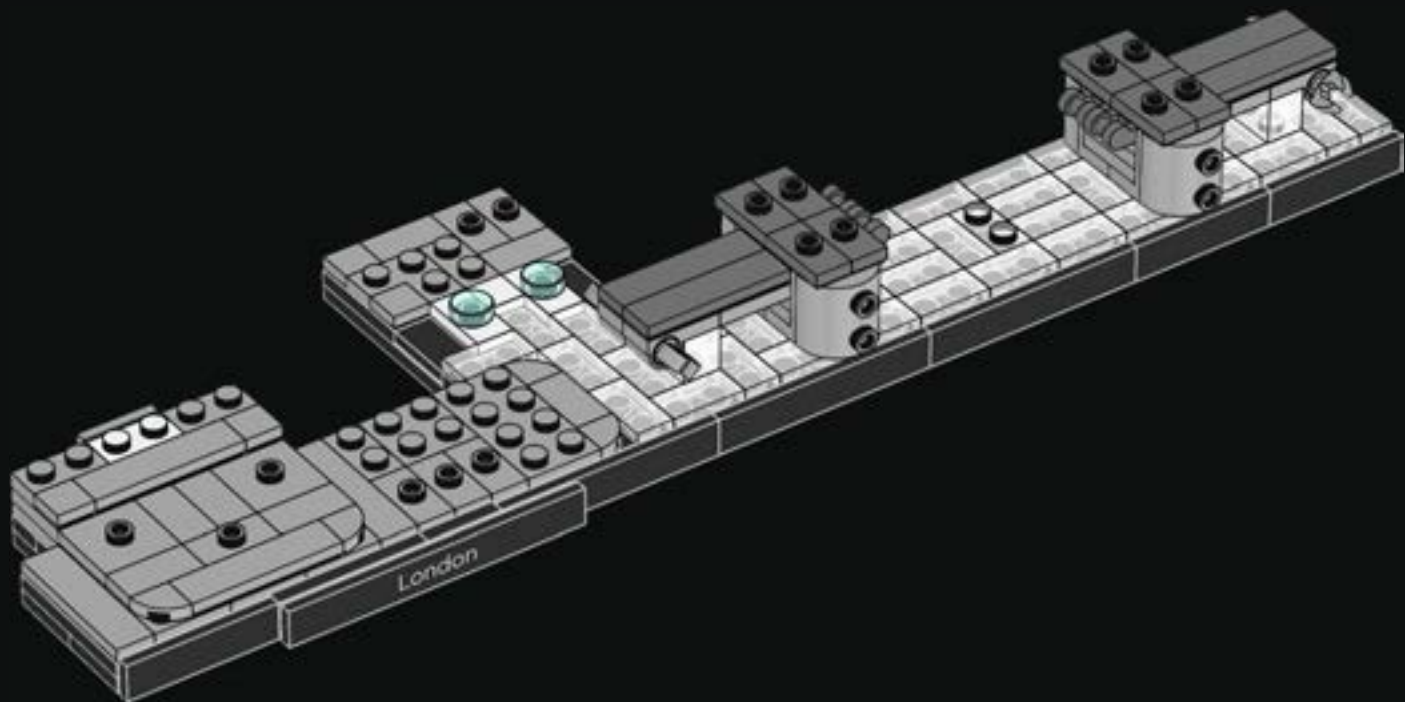



35

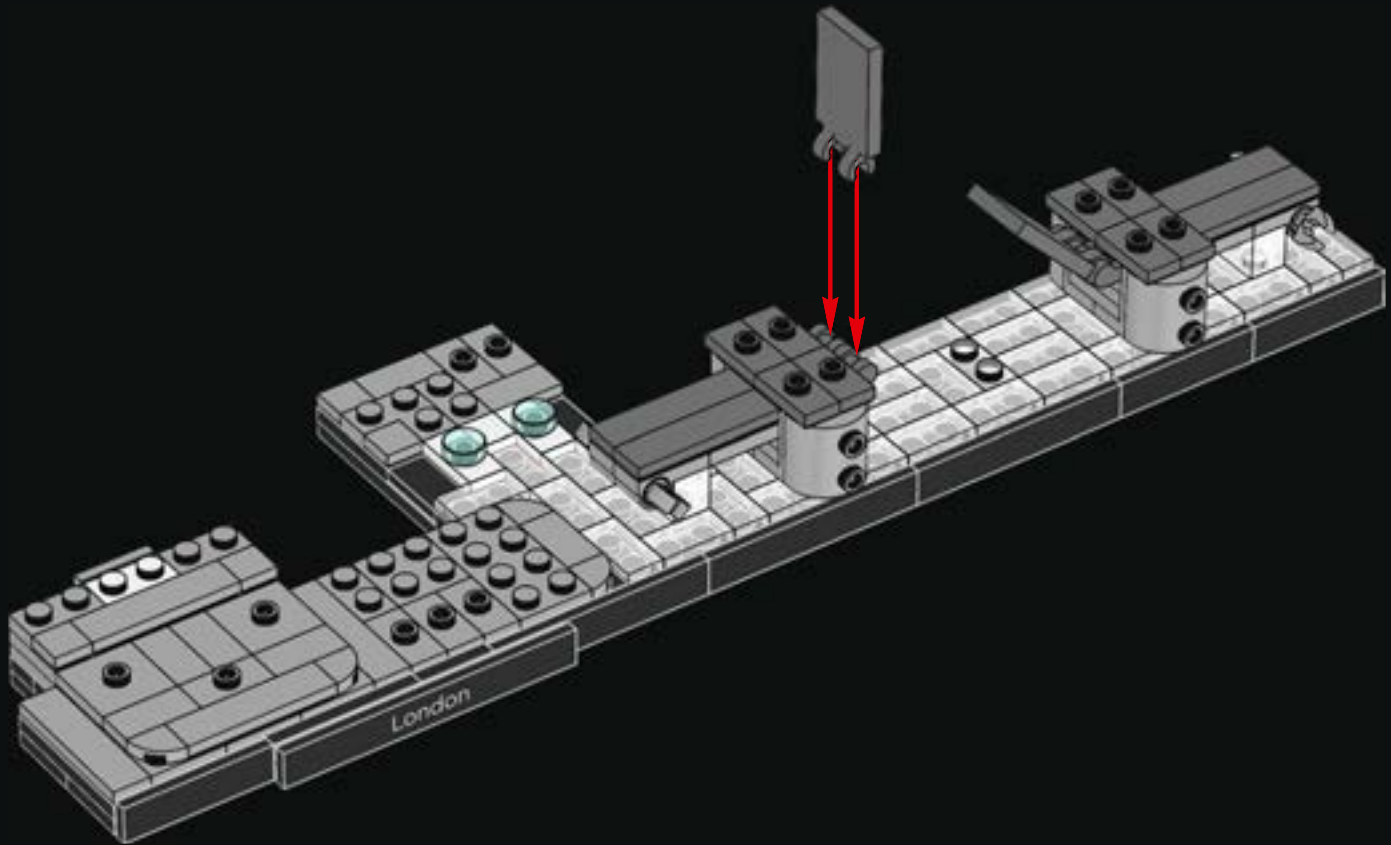



36

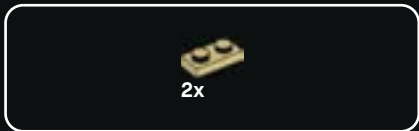

37



38



39





1x



2x

40



1x

41



1x

42



2x



1x

43





44



45



46

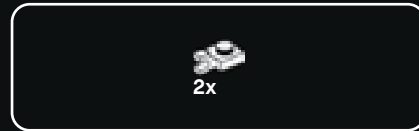

47



48

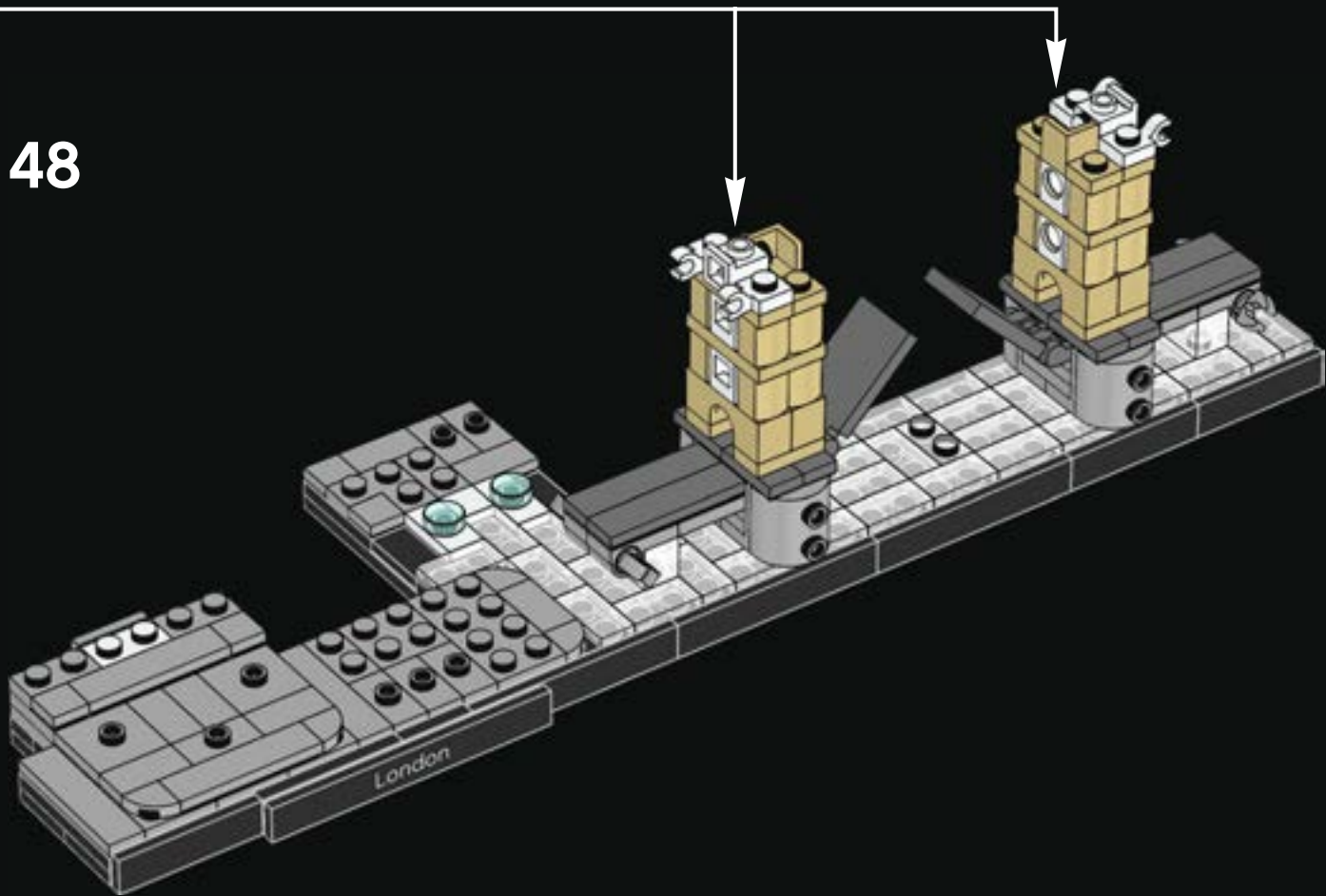



2x

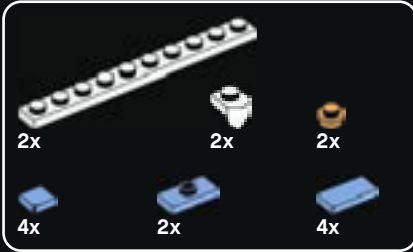

49

1



2

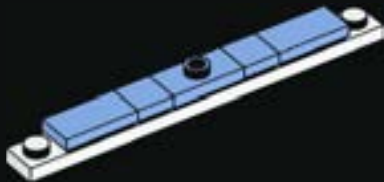

3



4



2x
53

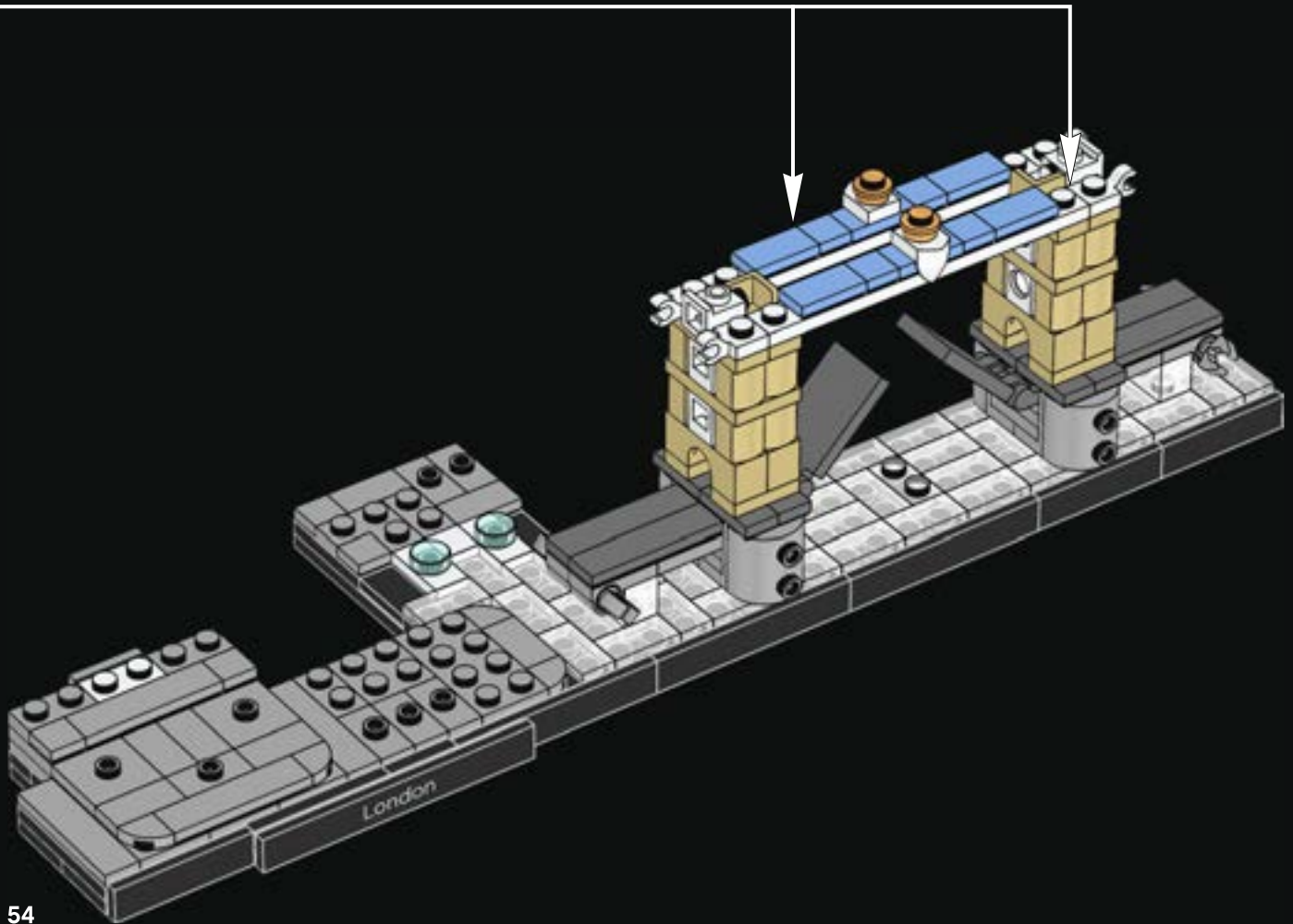



8x

50

The high-level walkways were designed so that the public could still cross the bridge when it was raised.

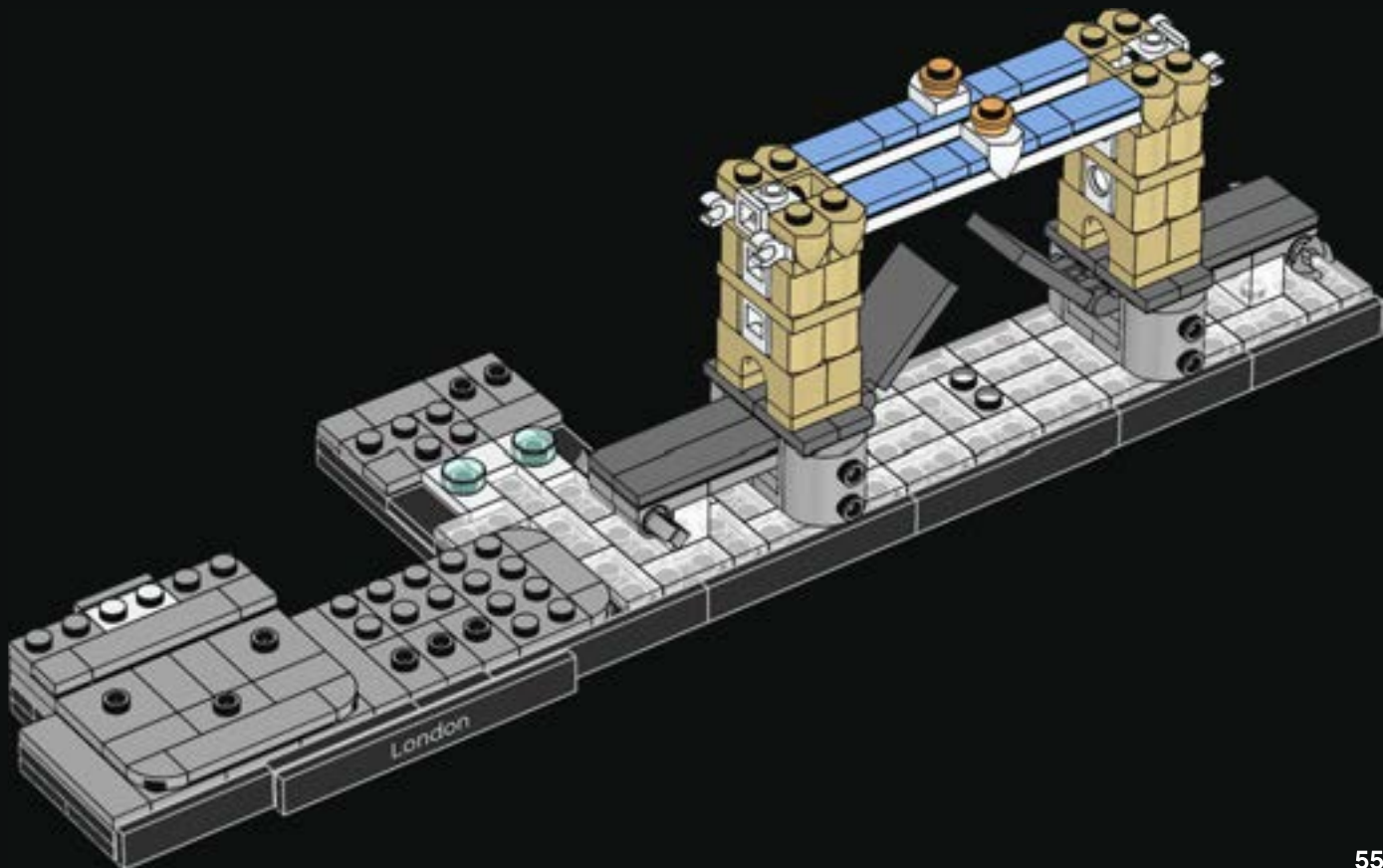



4x



4x

51

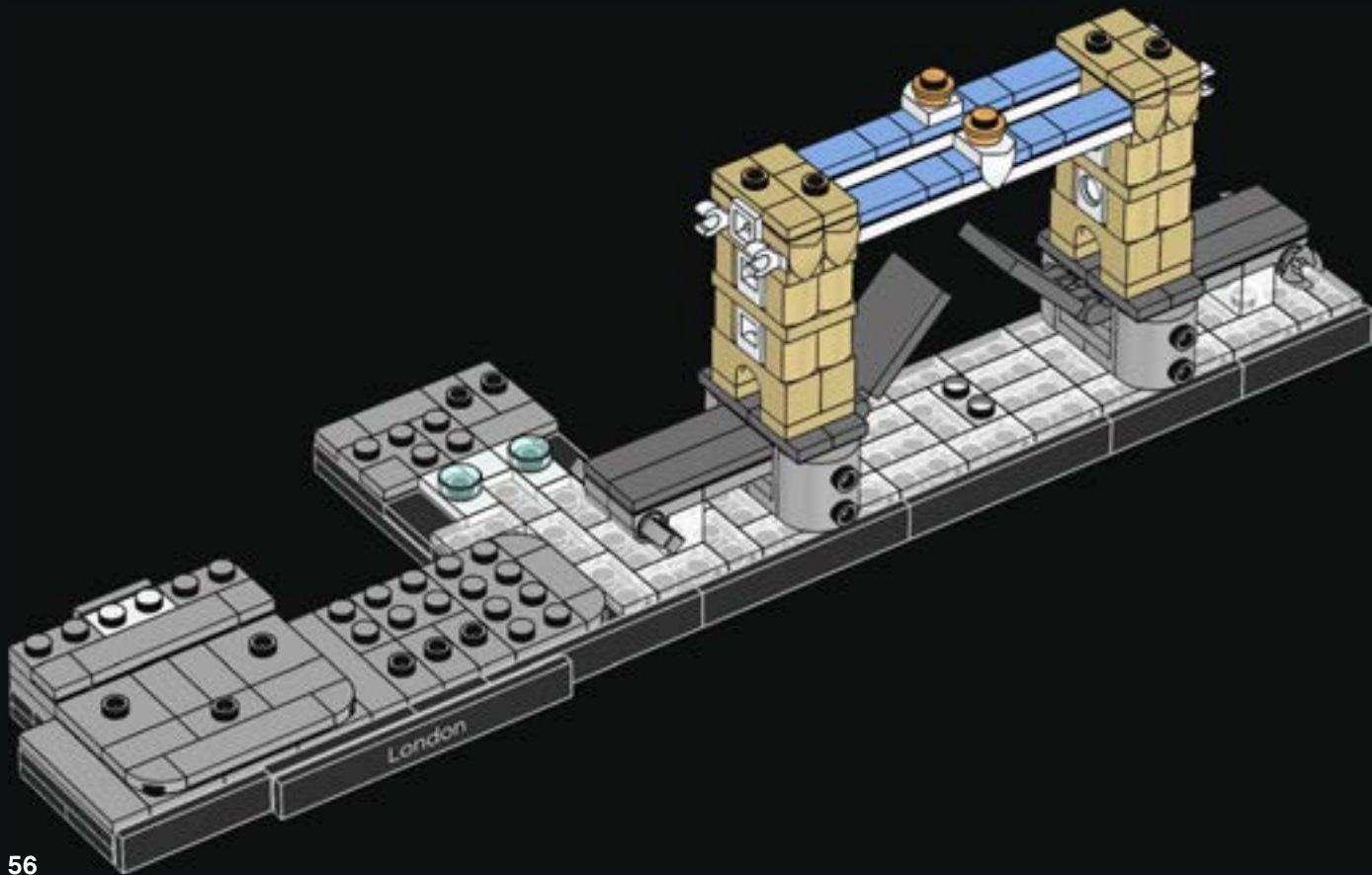

56



52

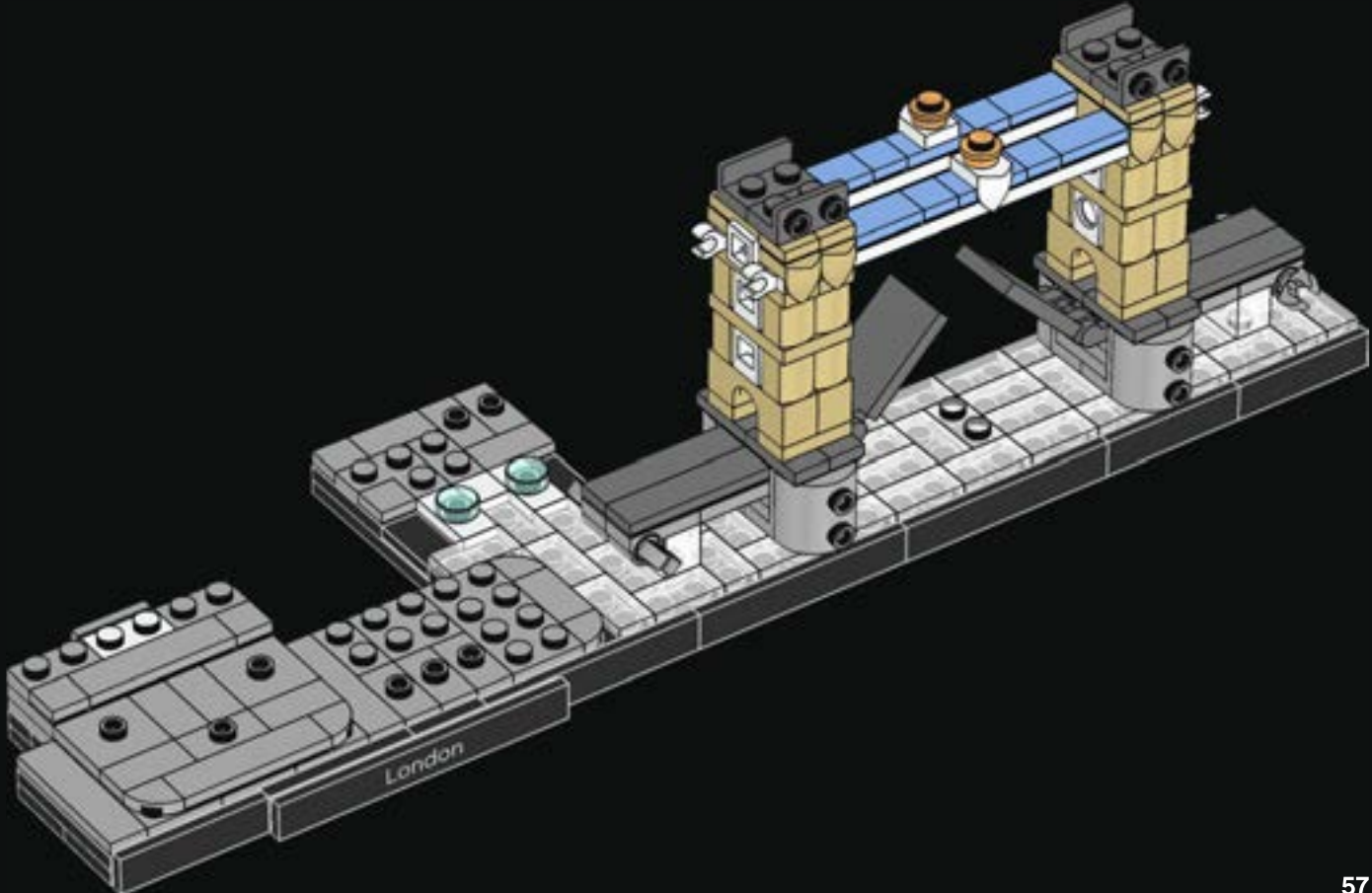



4x

53

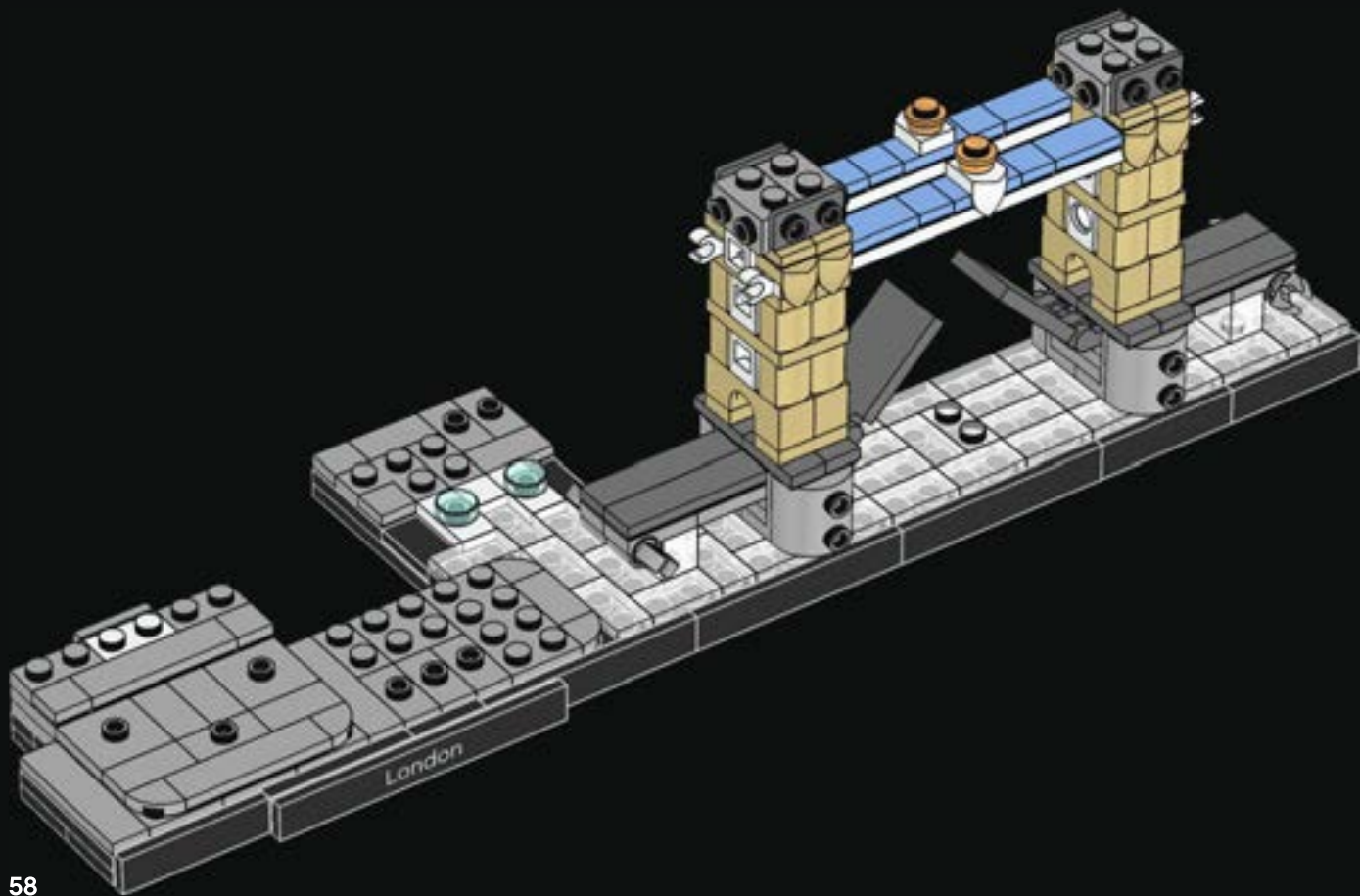

58

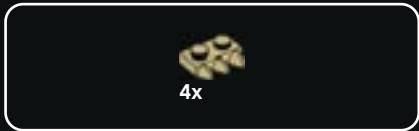

54

The bridge's lifting mechanism was originally powered by steam, but is now driven by oil and electricity.

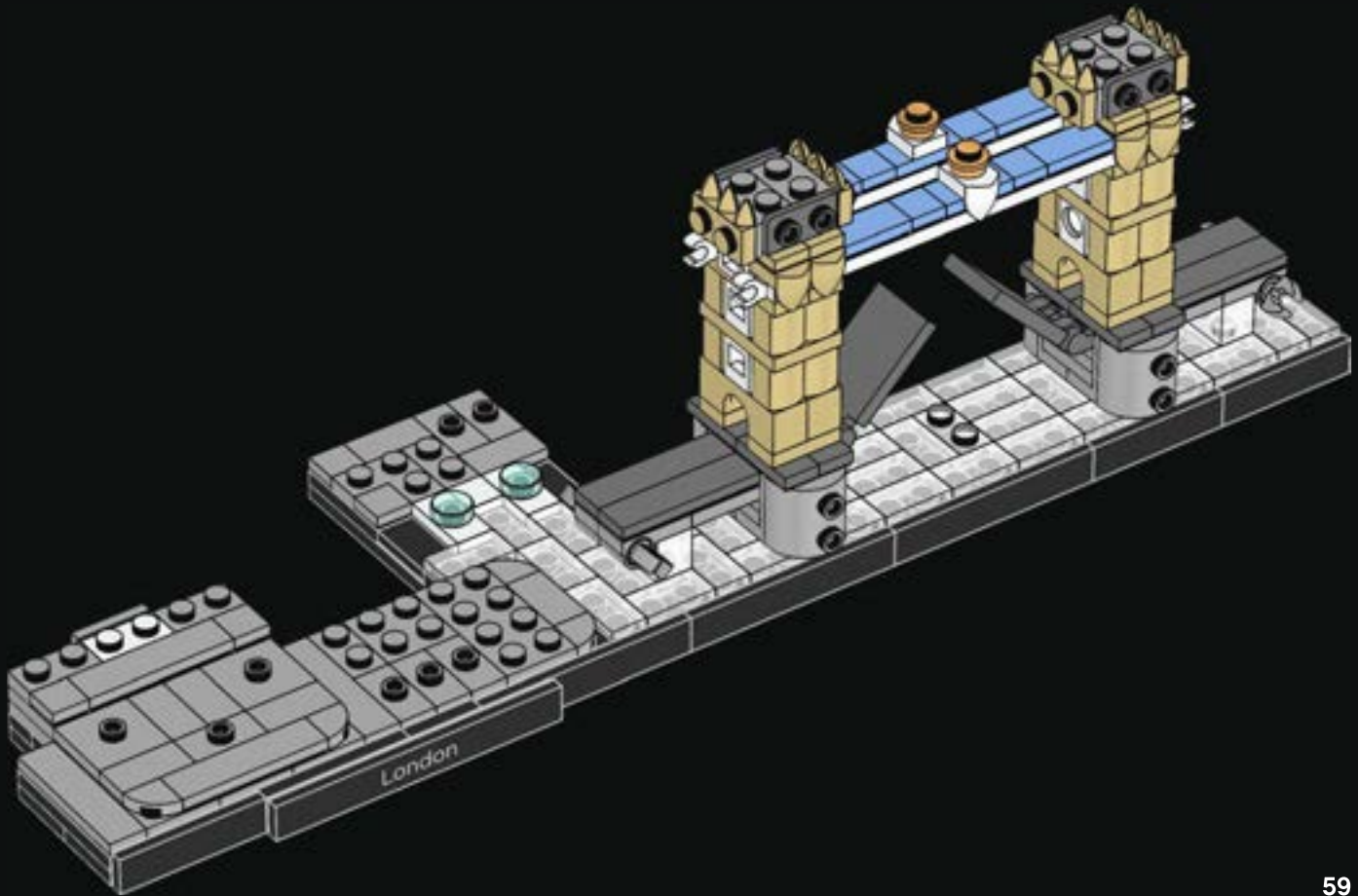



8x

55

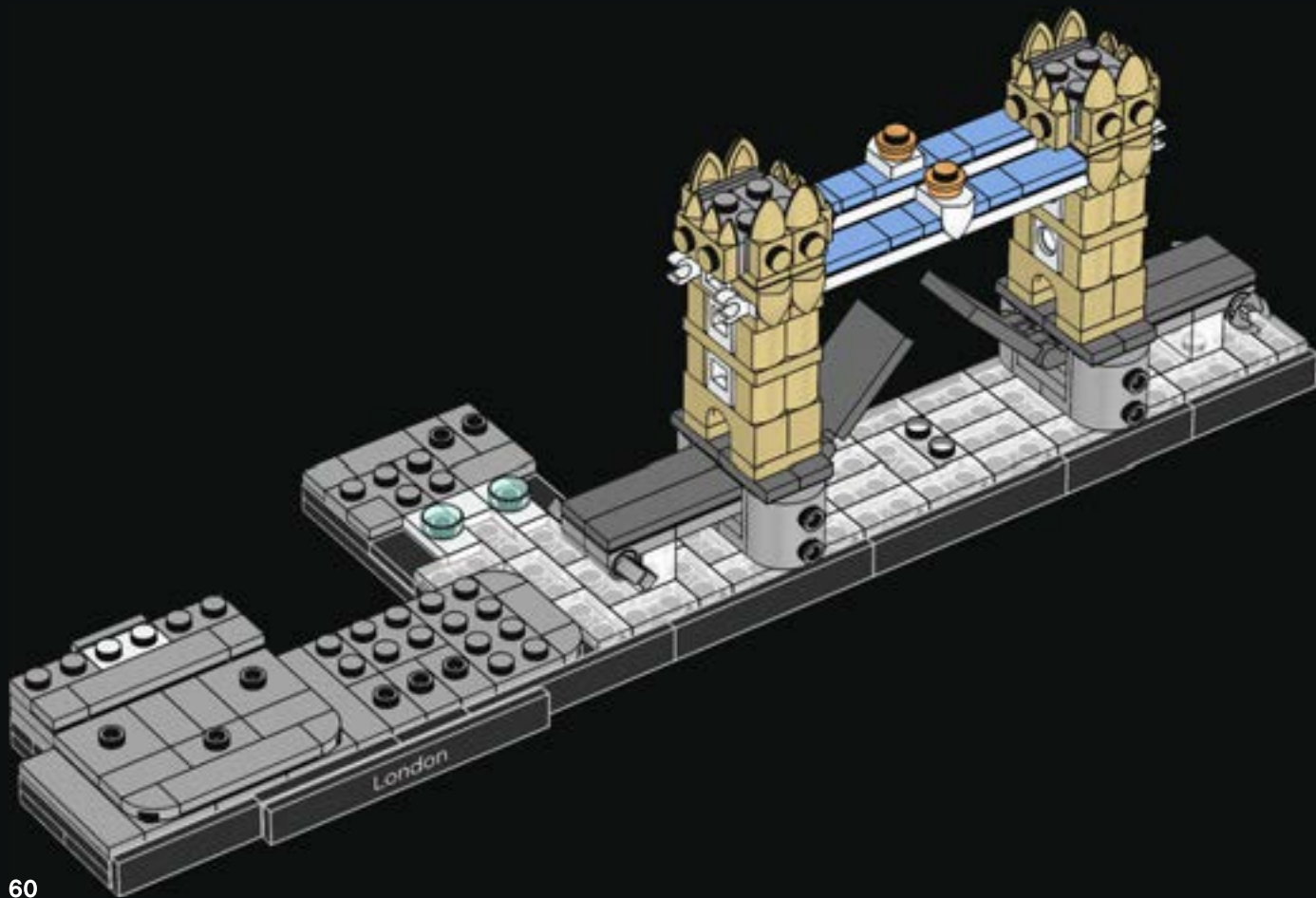

60

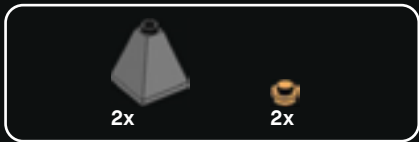

56

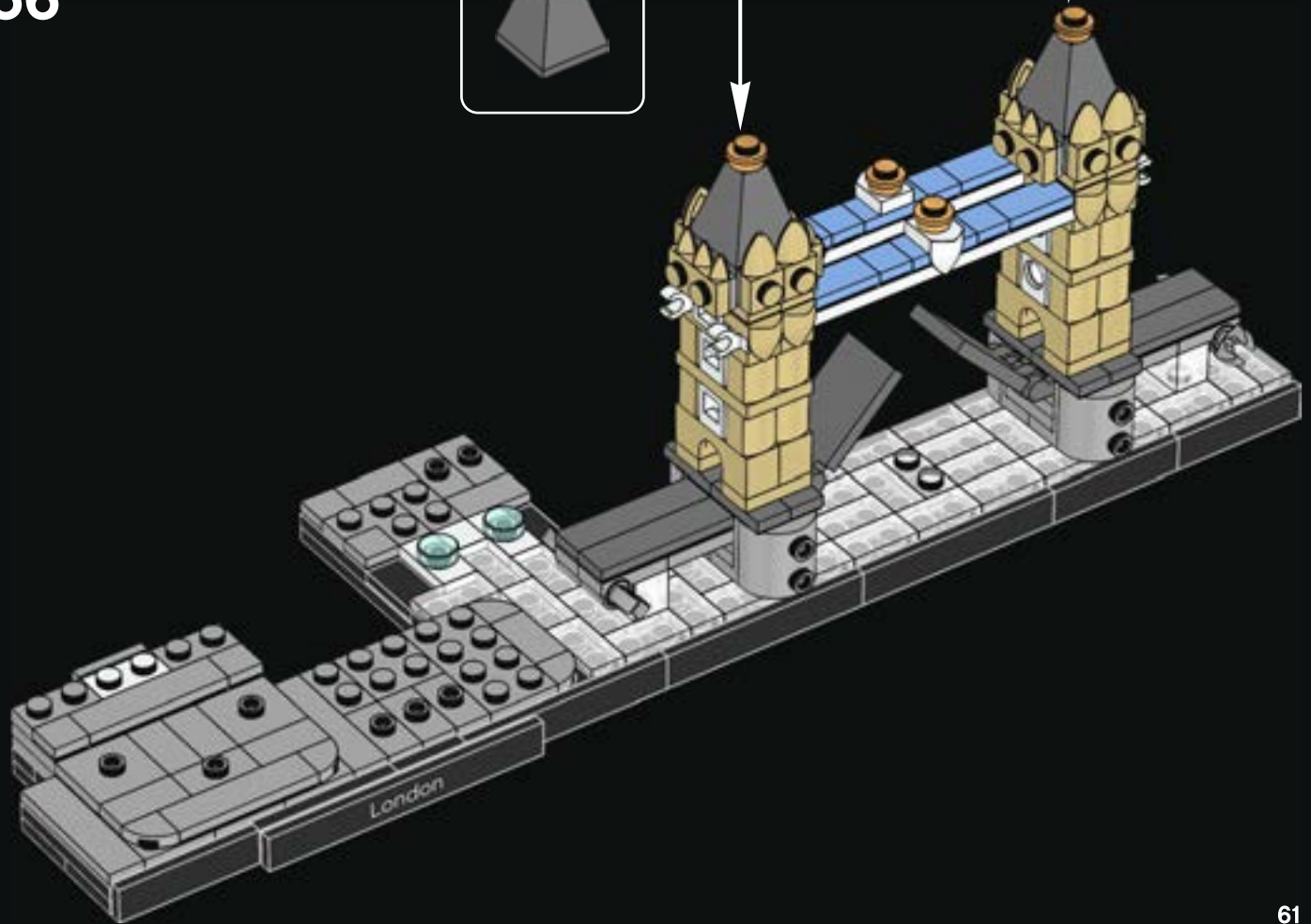



57

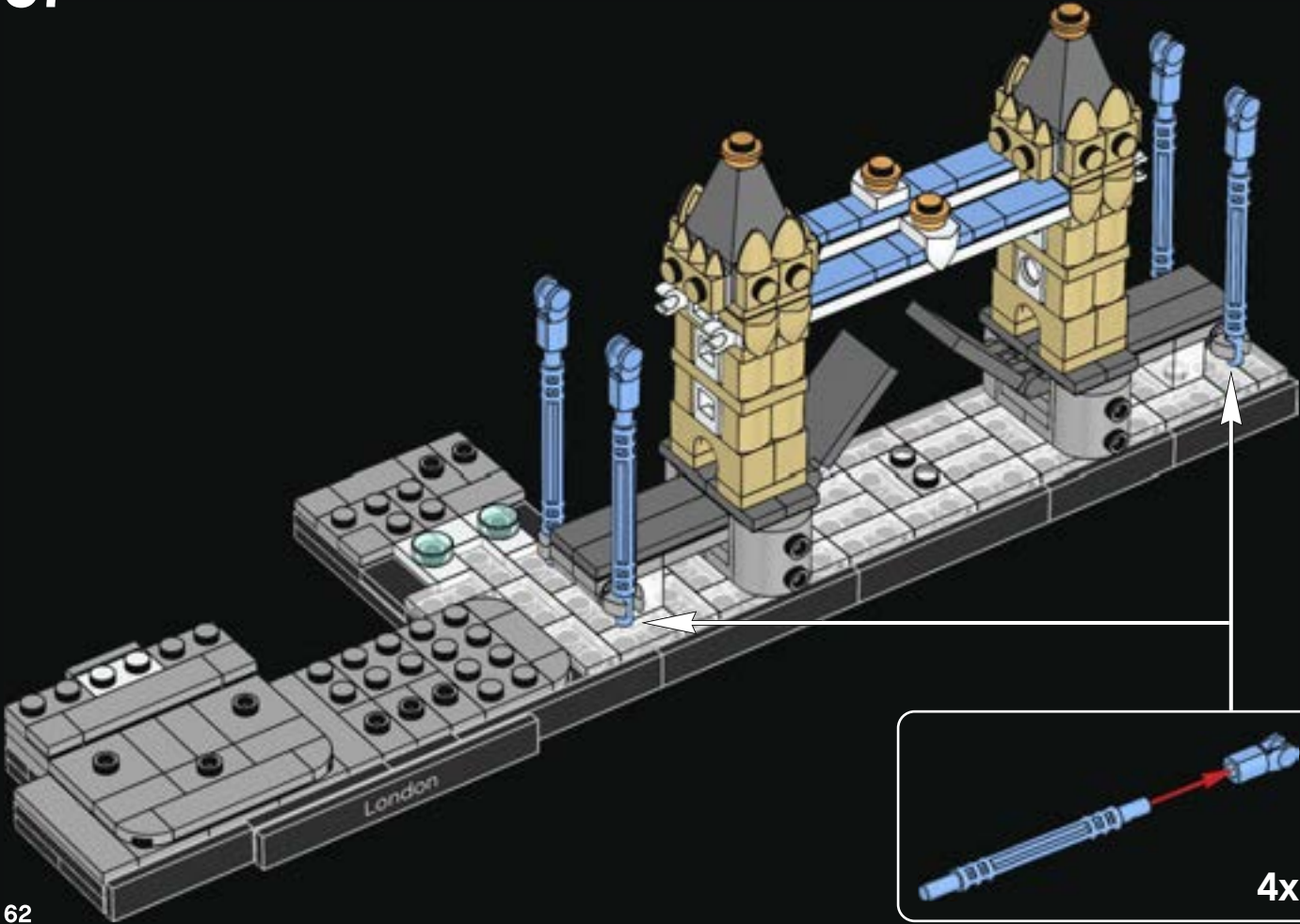



58

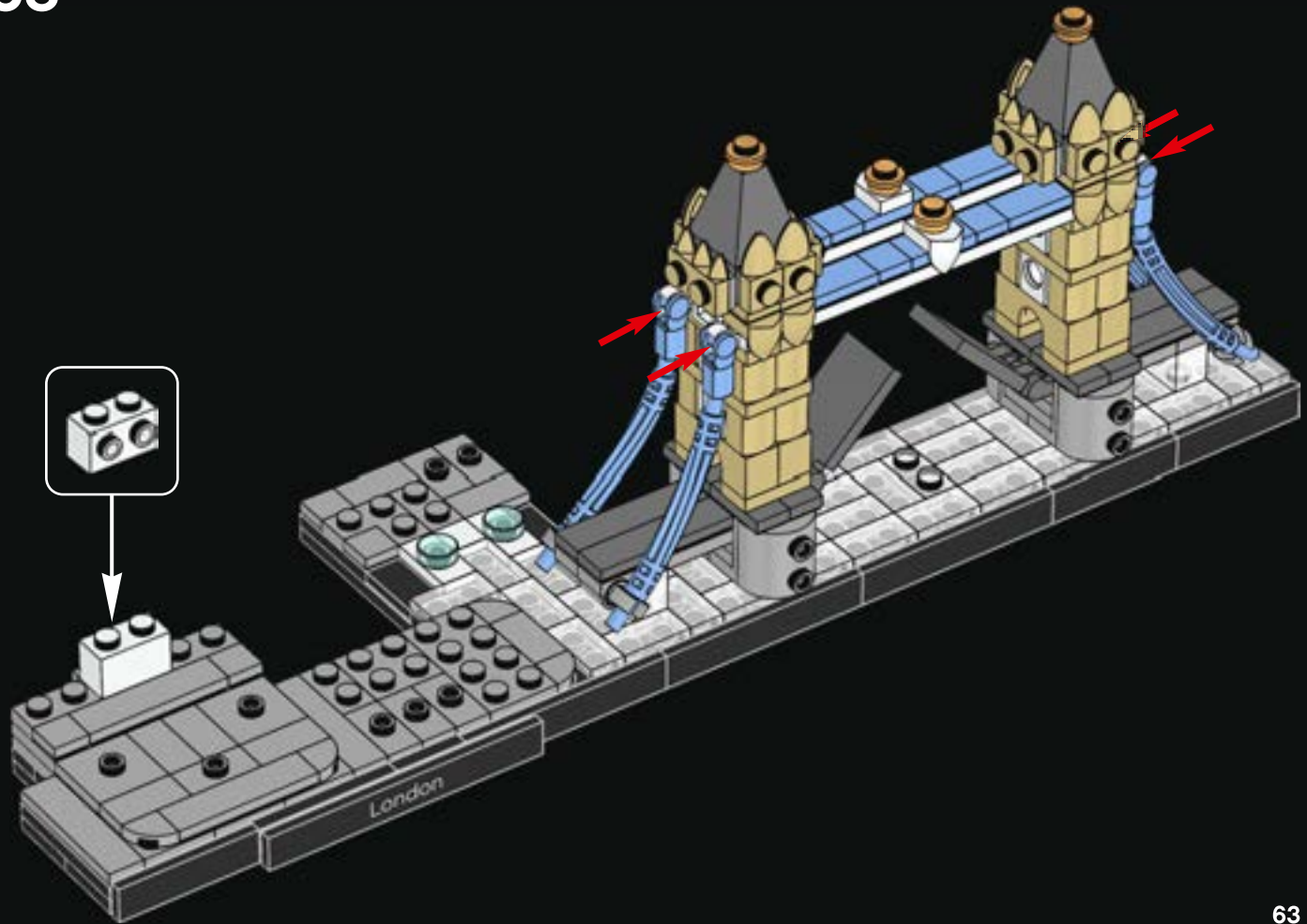



6x

59

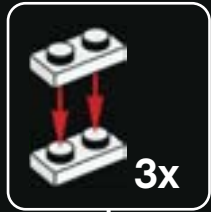

3x

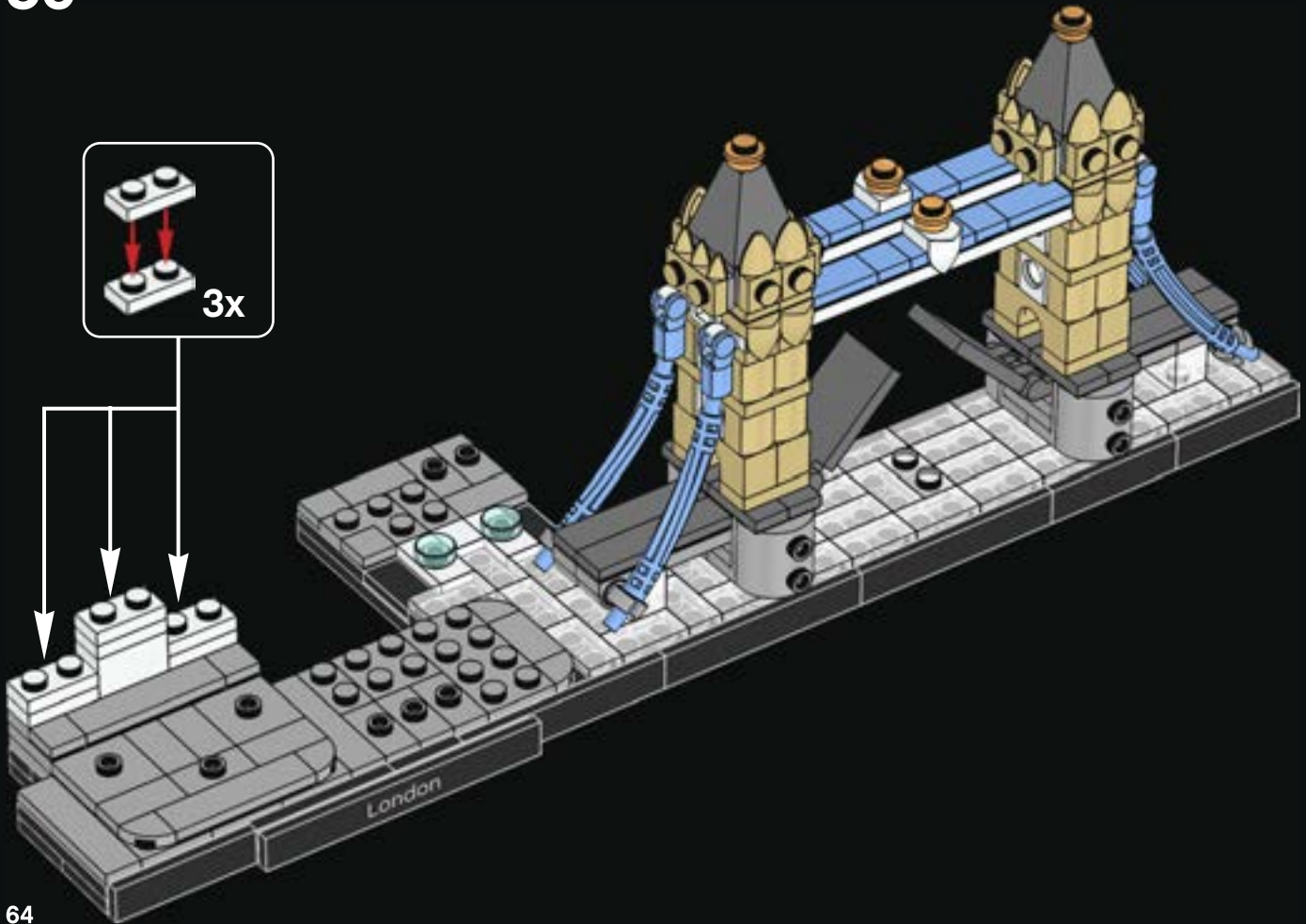

64



2x

60

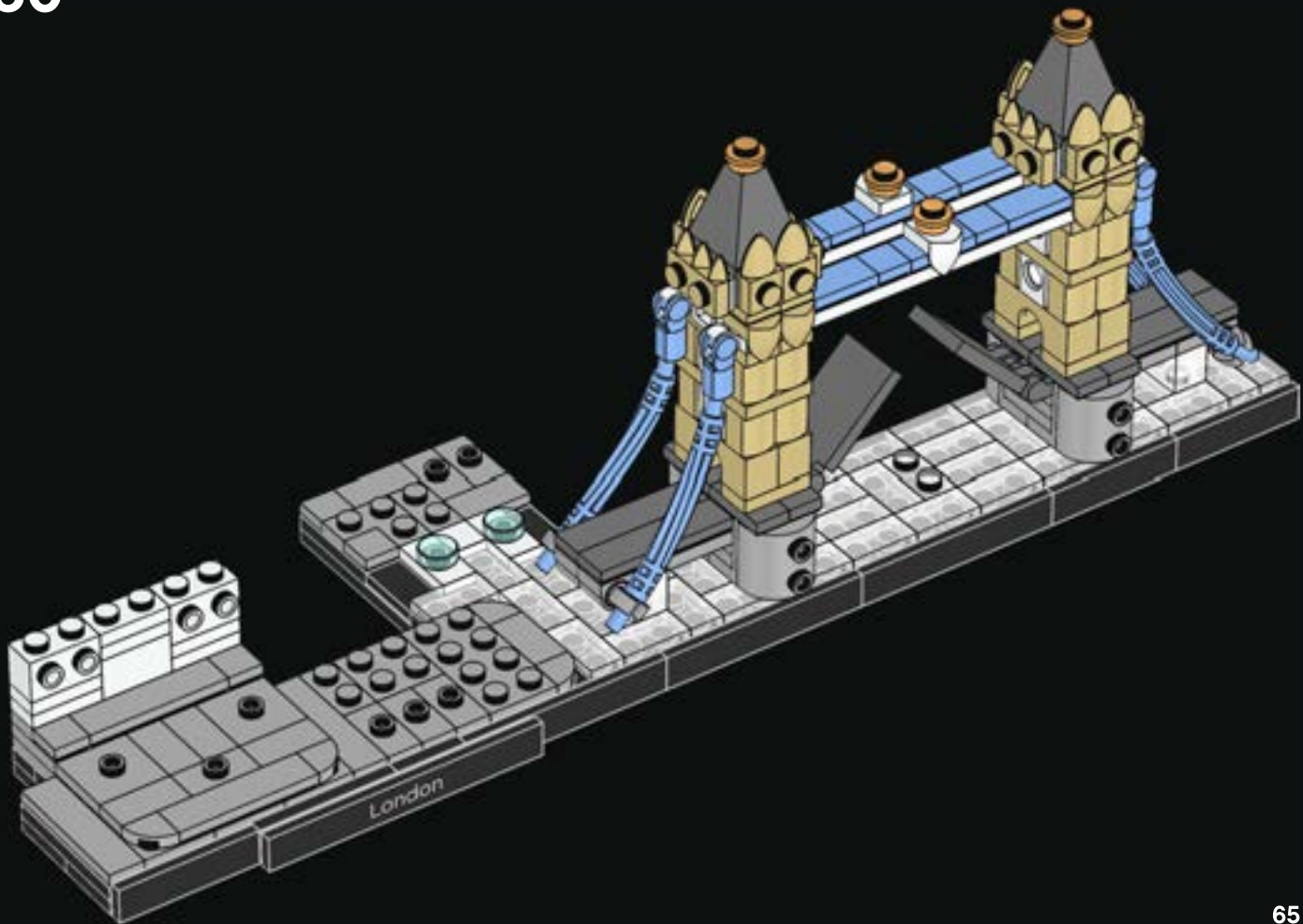



61

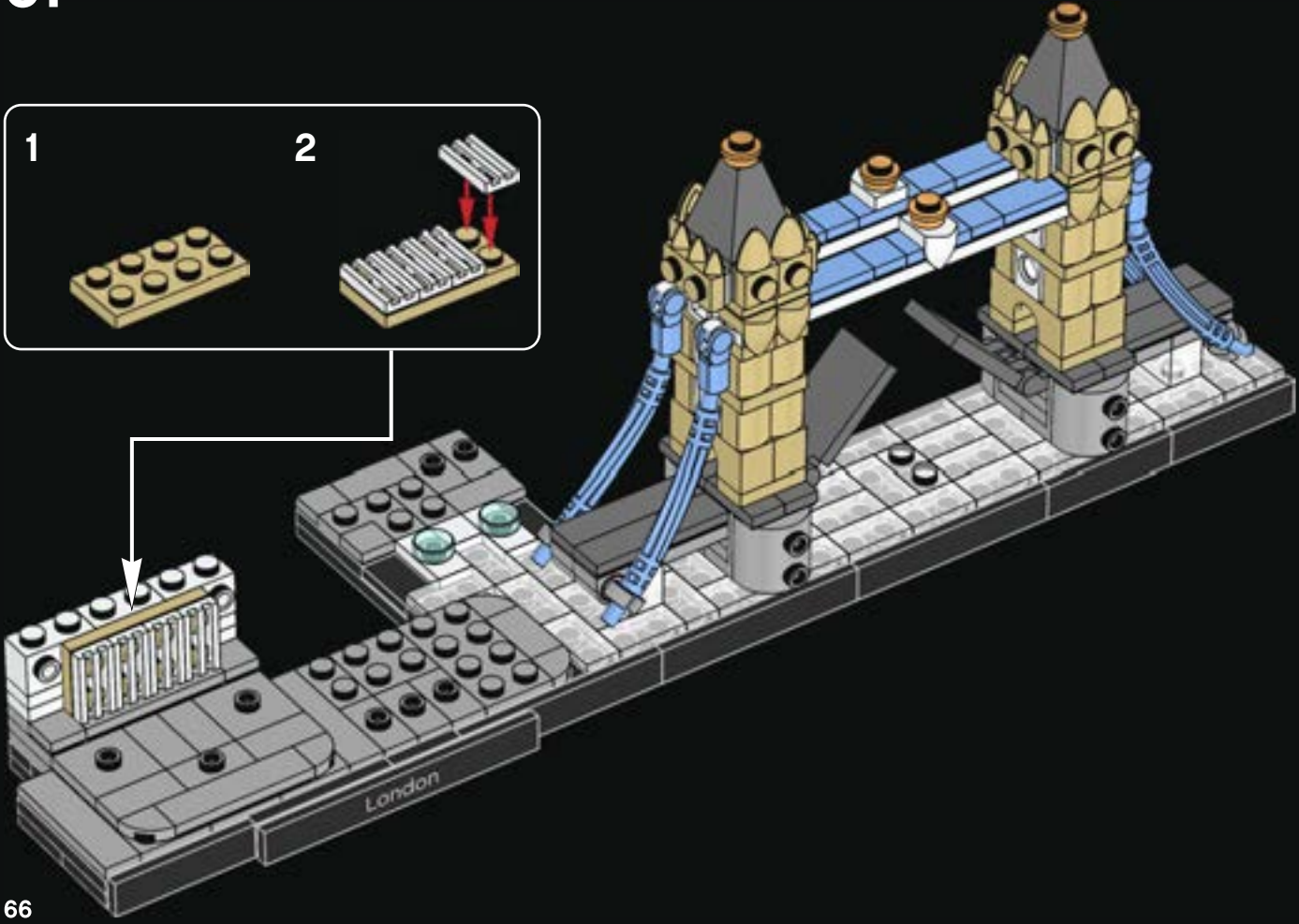

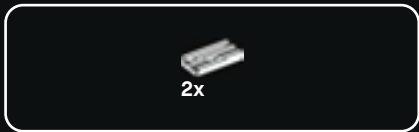

62

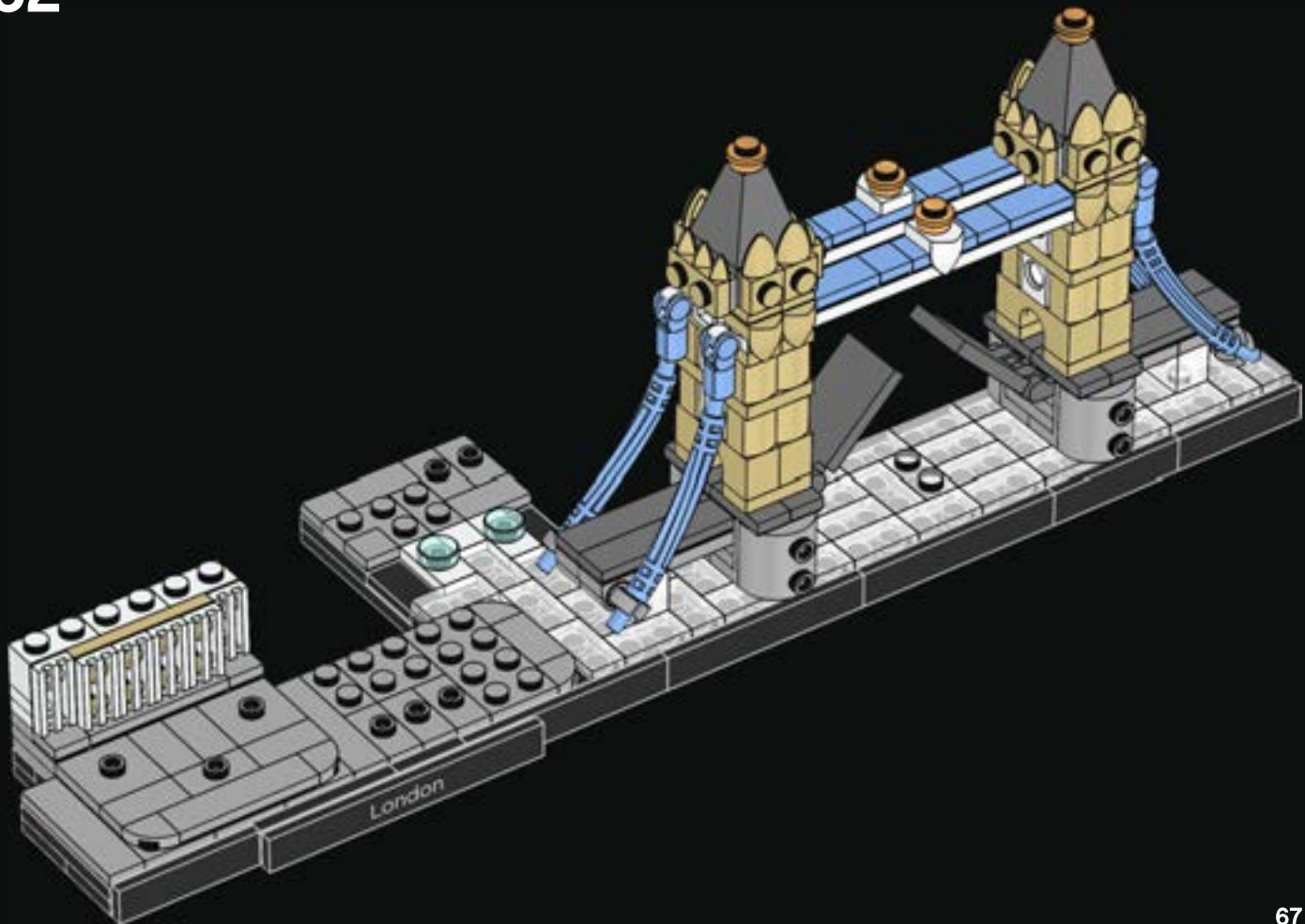



63

1



2



3



4



The National Gallery stands on the former site of the Kings Mews, the building where the King's horses were stabled.

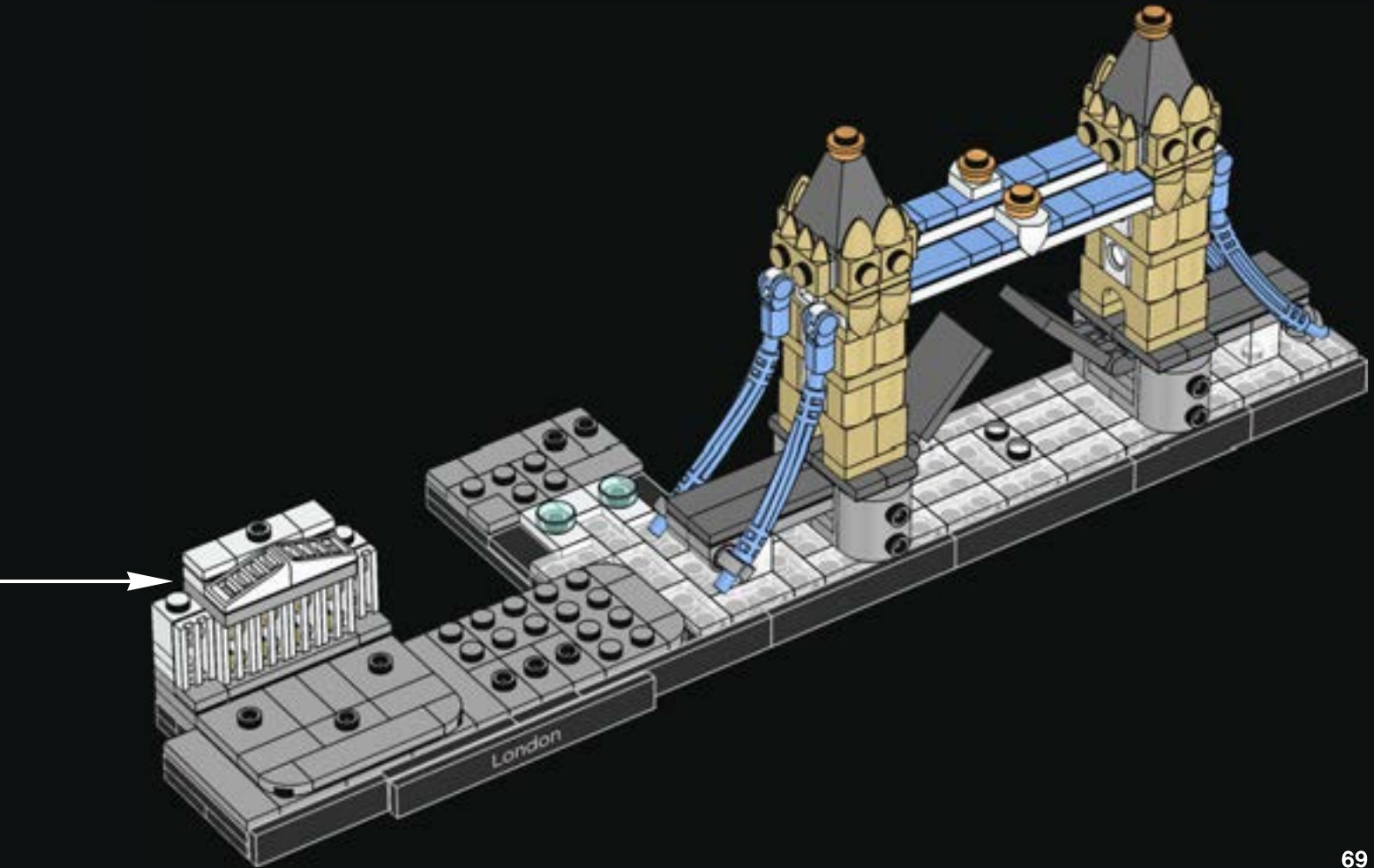



2x

64

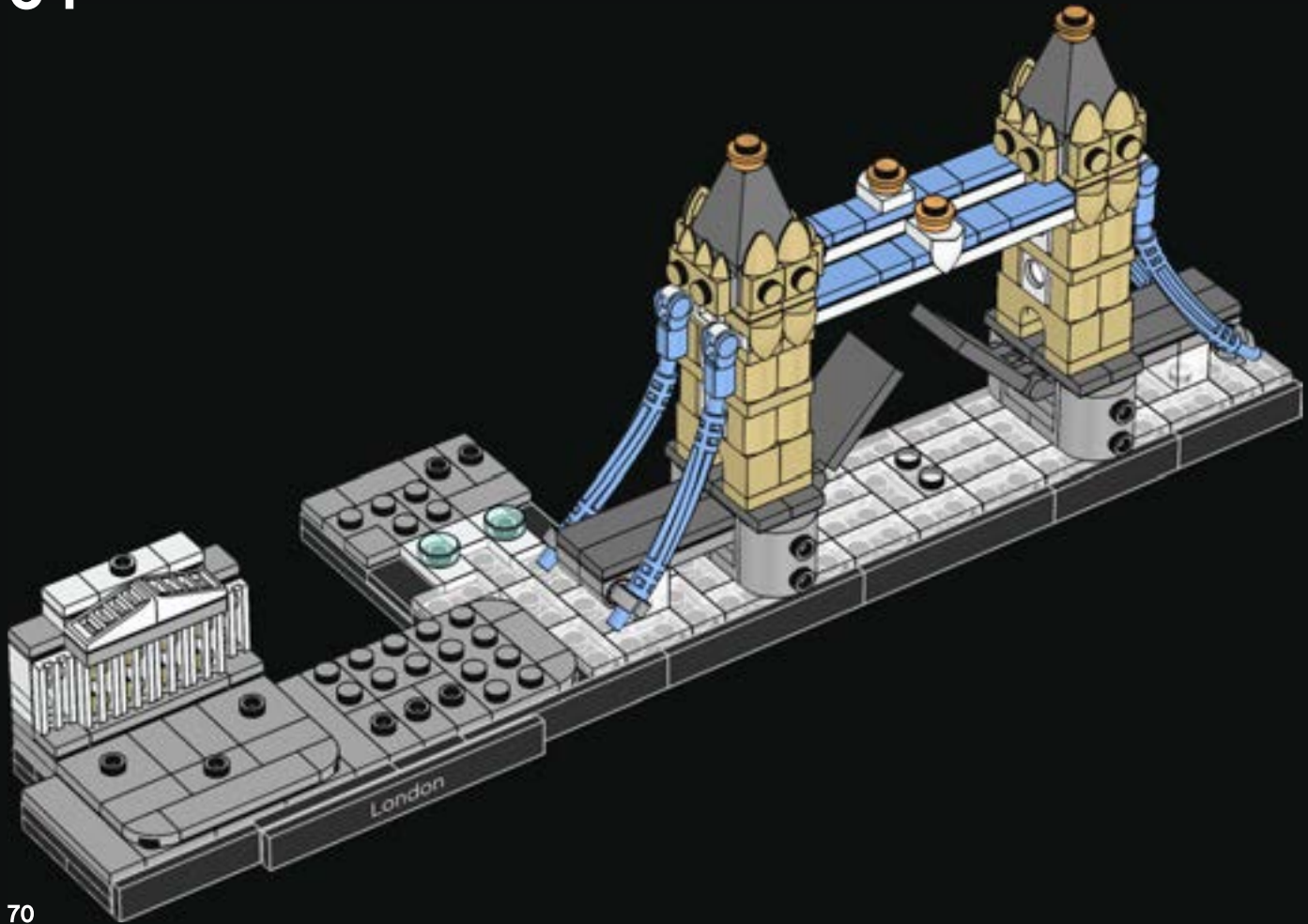

70



65

Several new rooms and the impressive dome were added to the building in 1876.

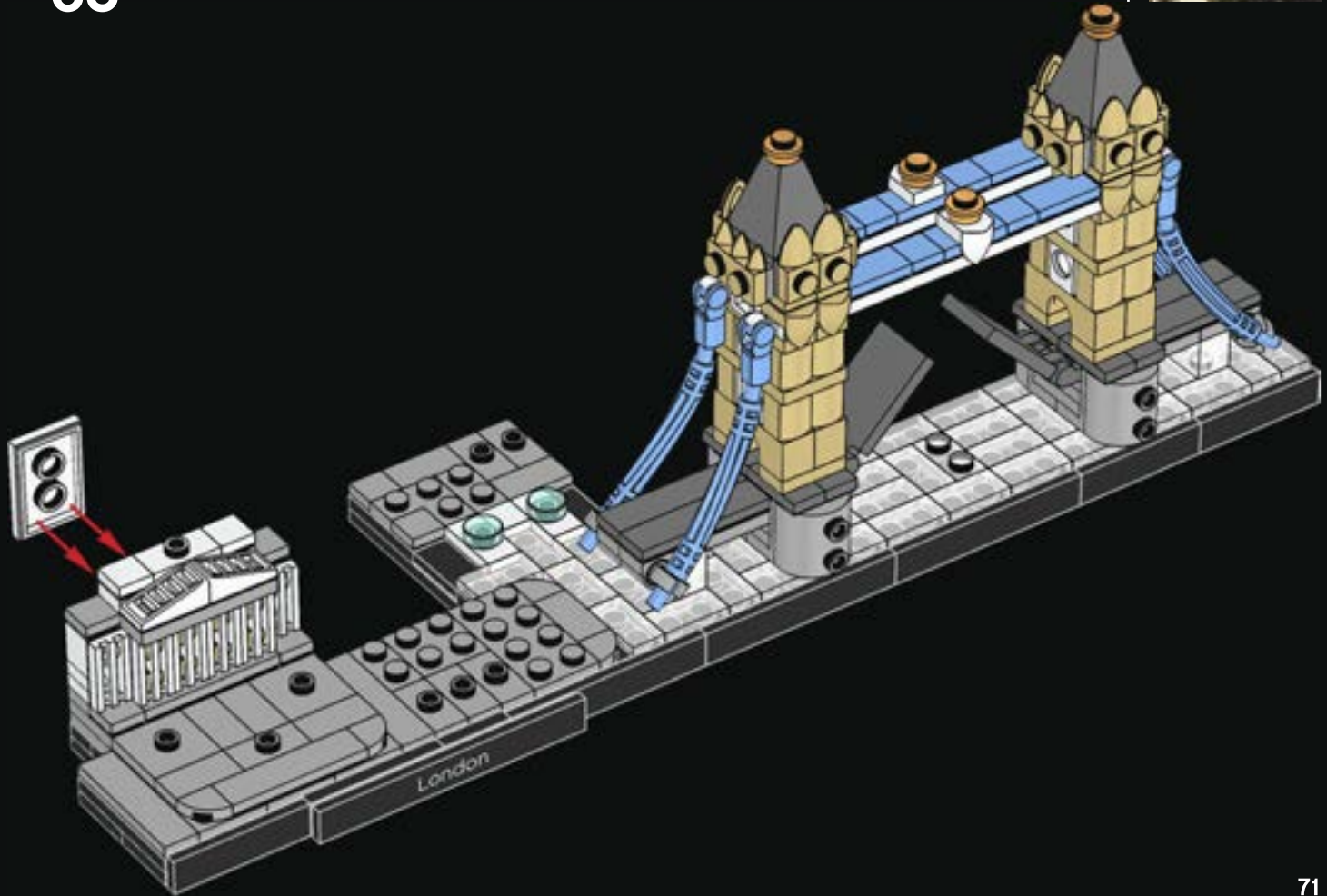

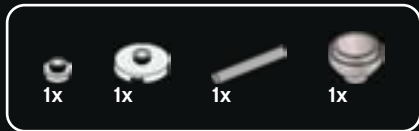

66

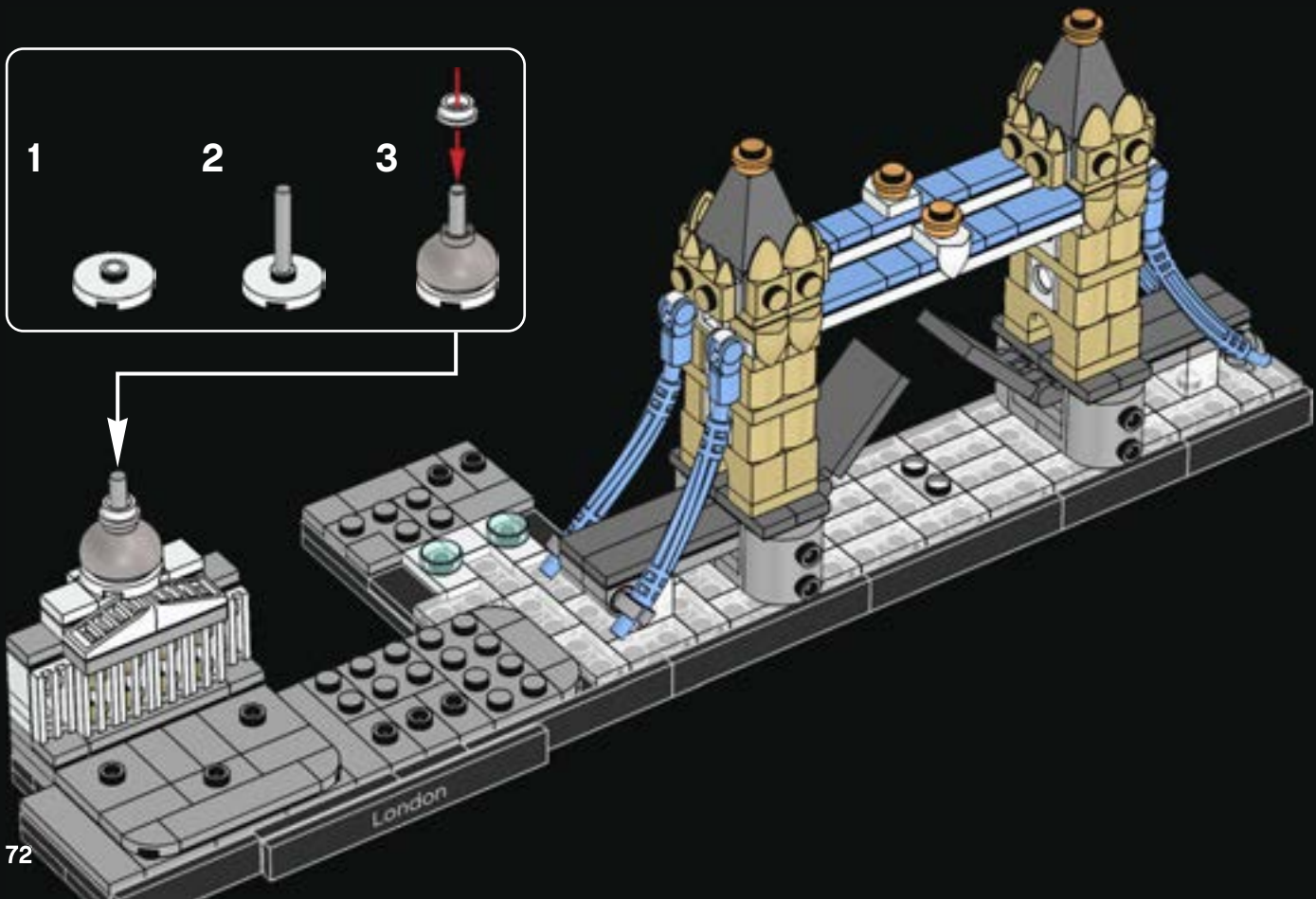
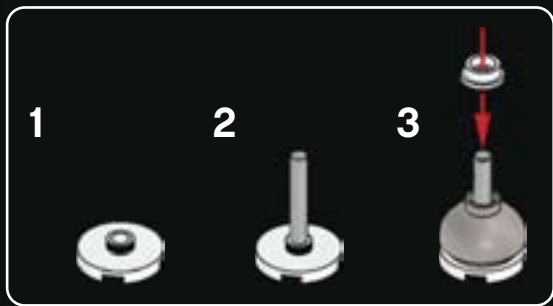



67

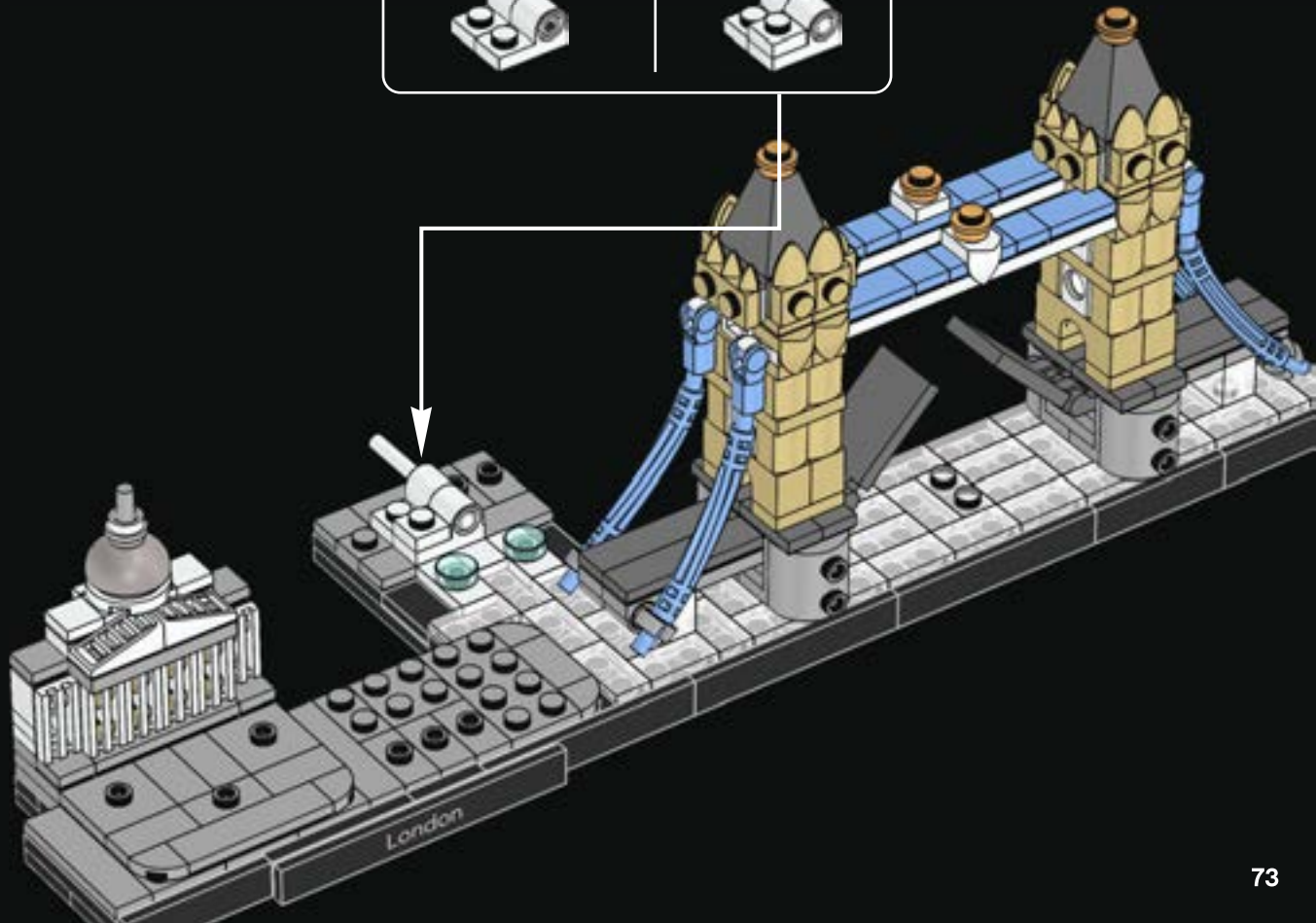
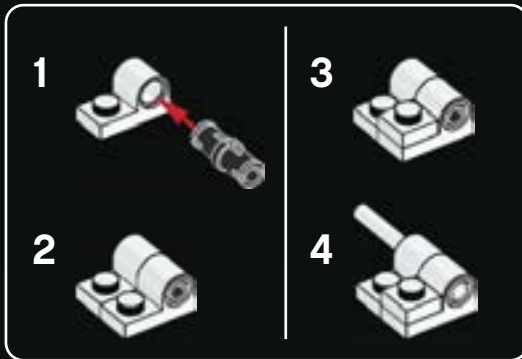



1x



1x

68

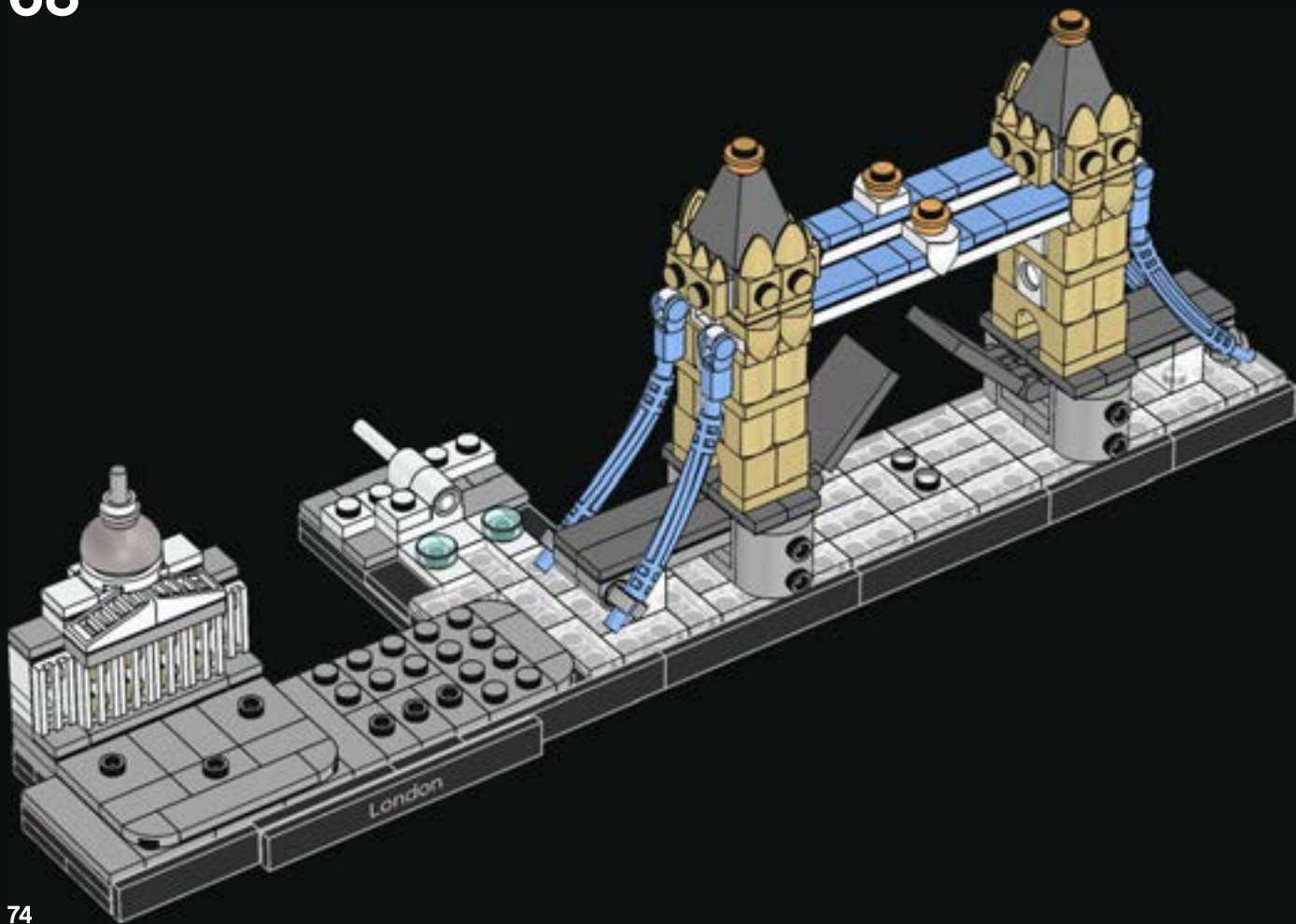

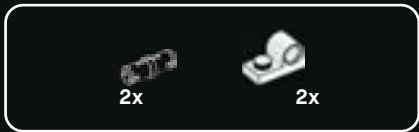

69

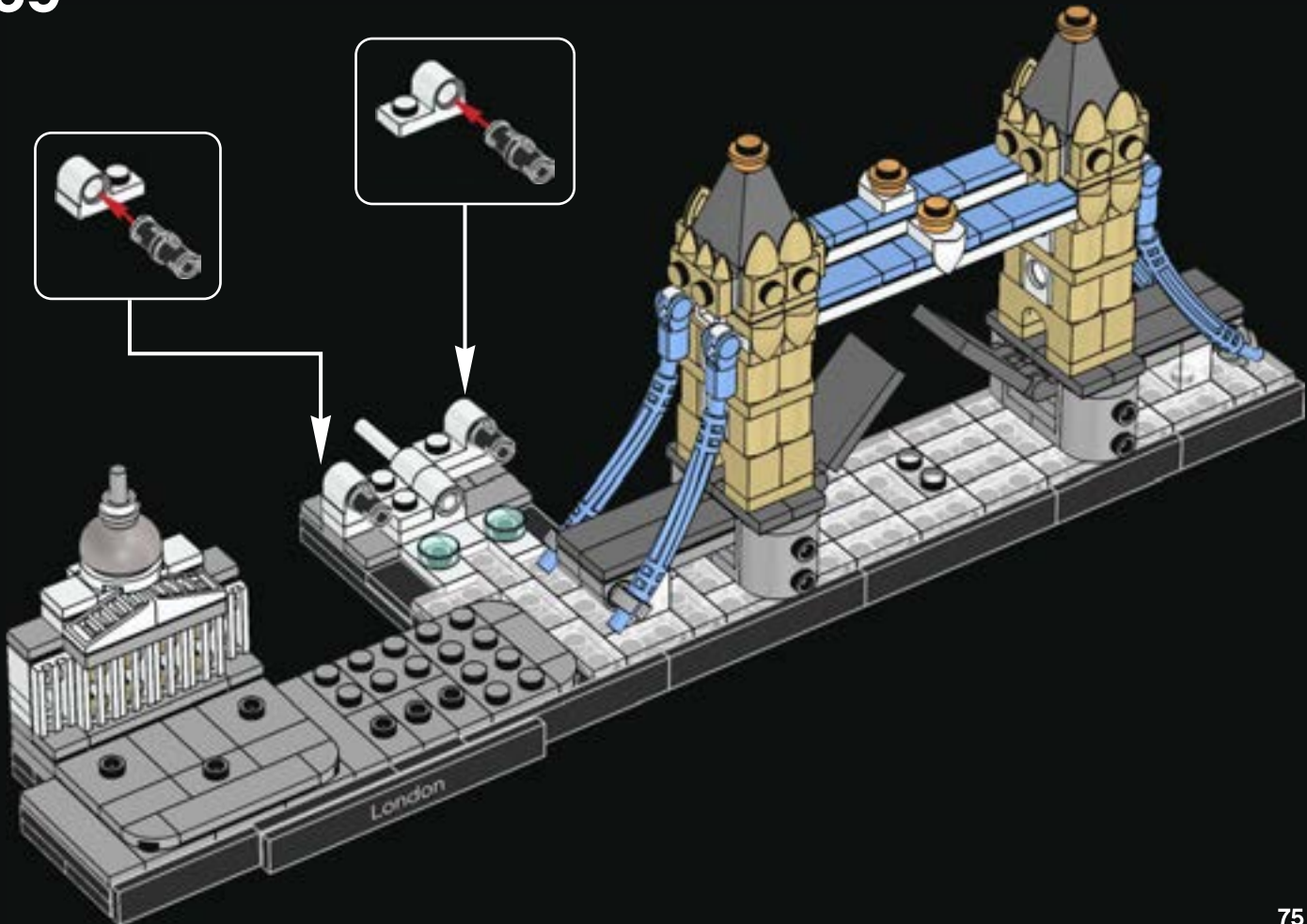



1x



1x

70

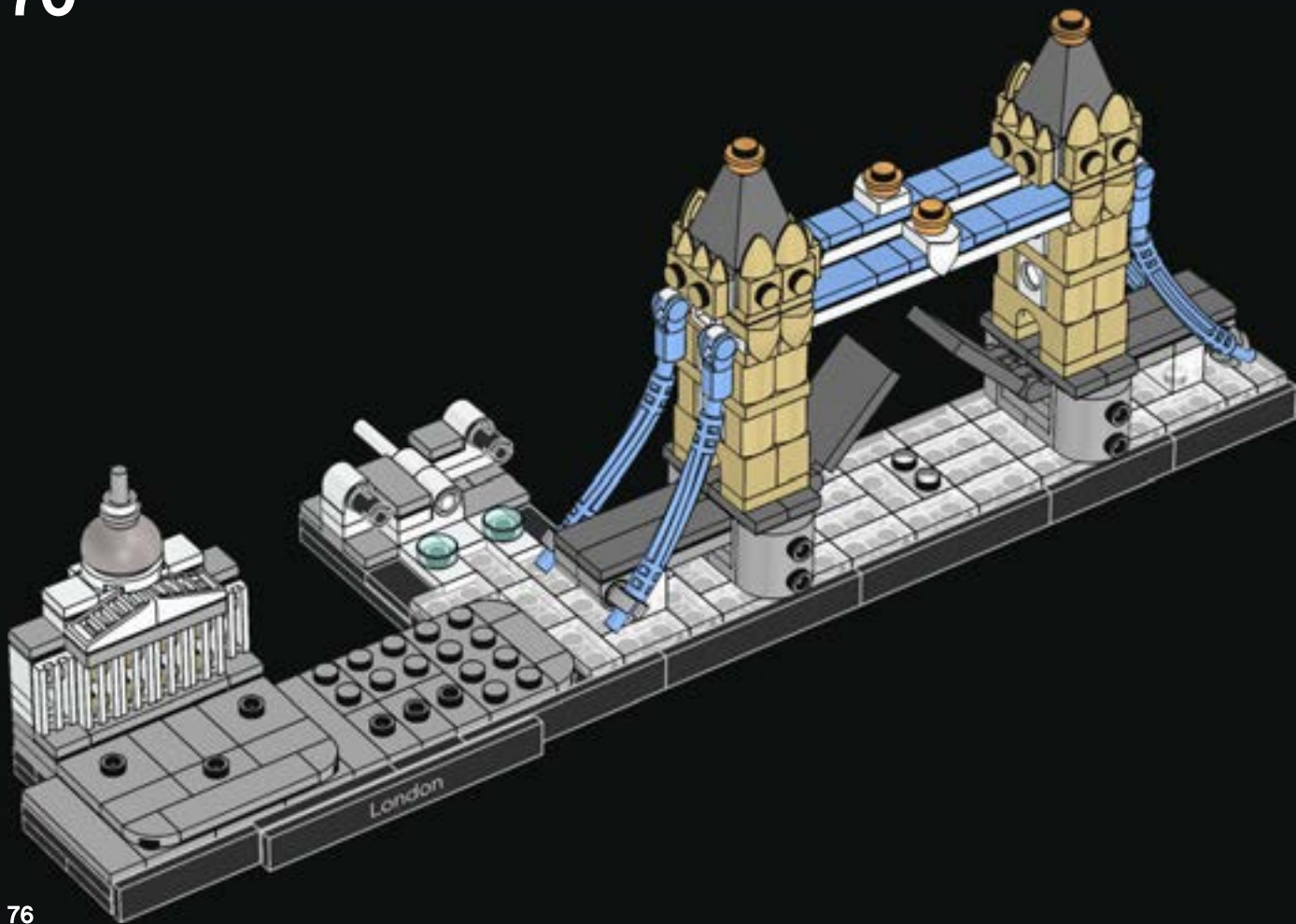

76



71

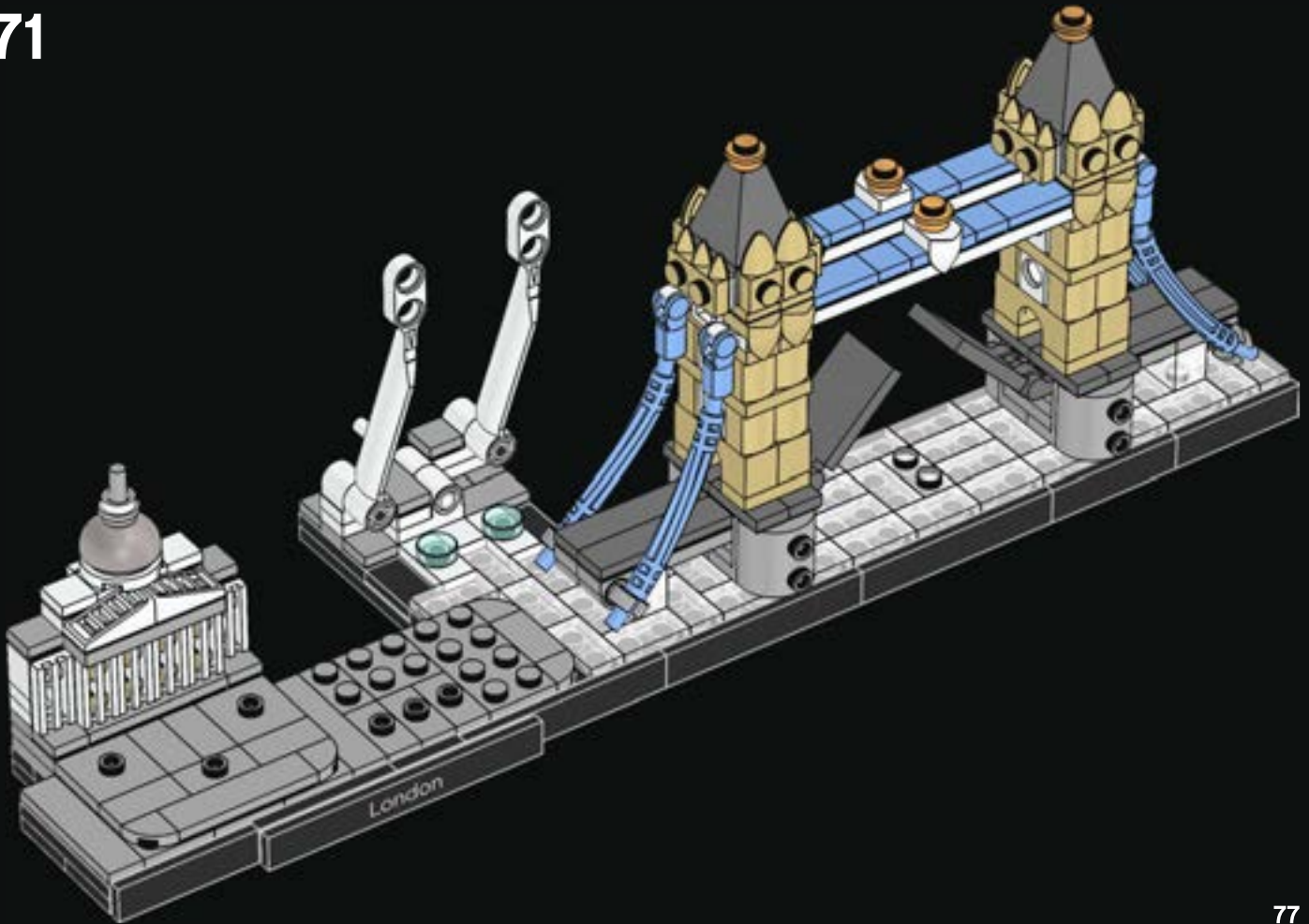



1x

72

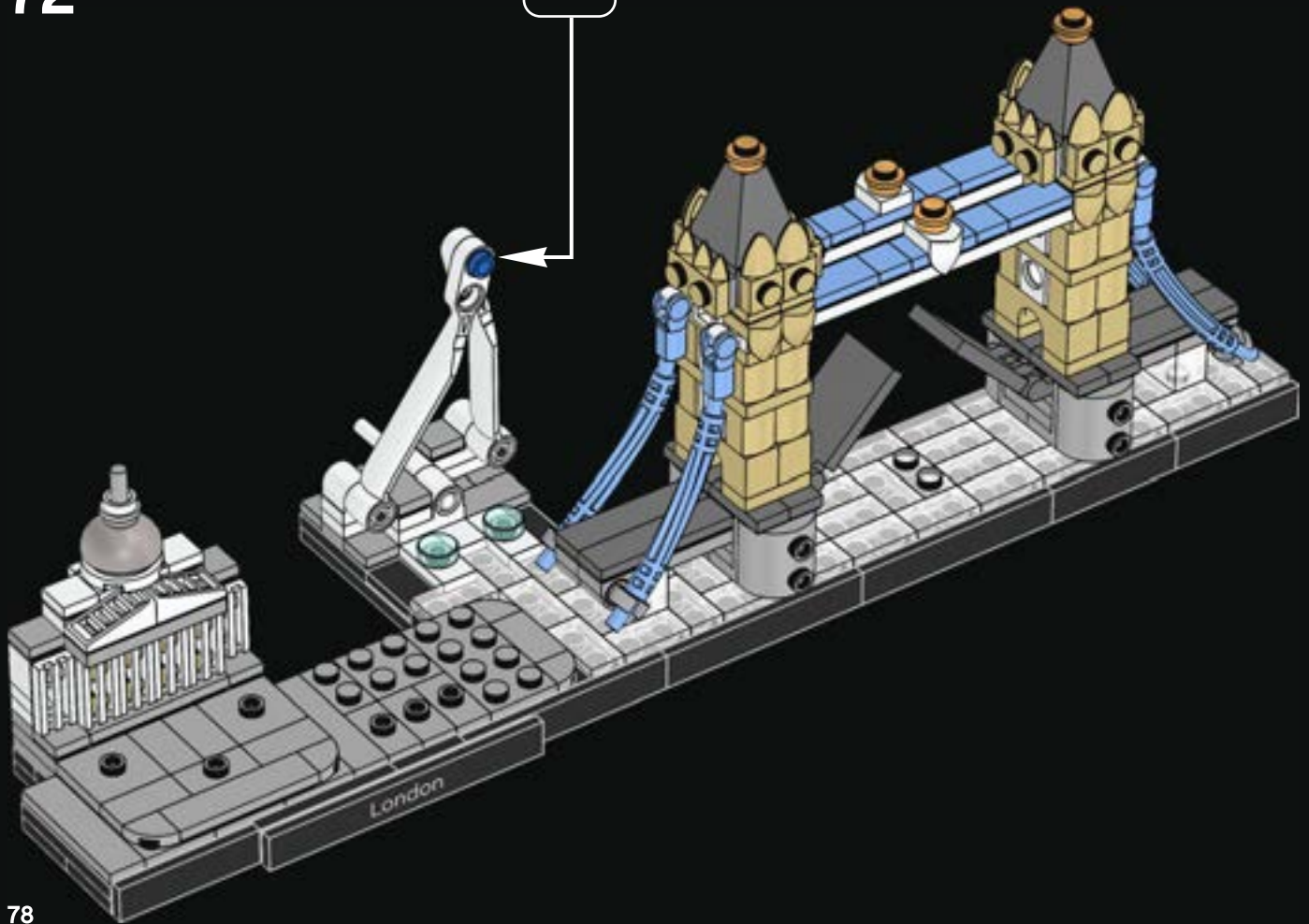

78

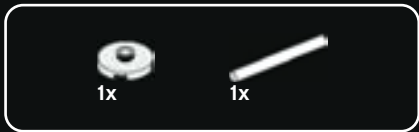

73

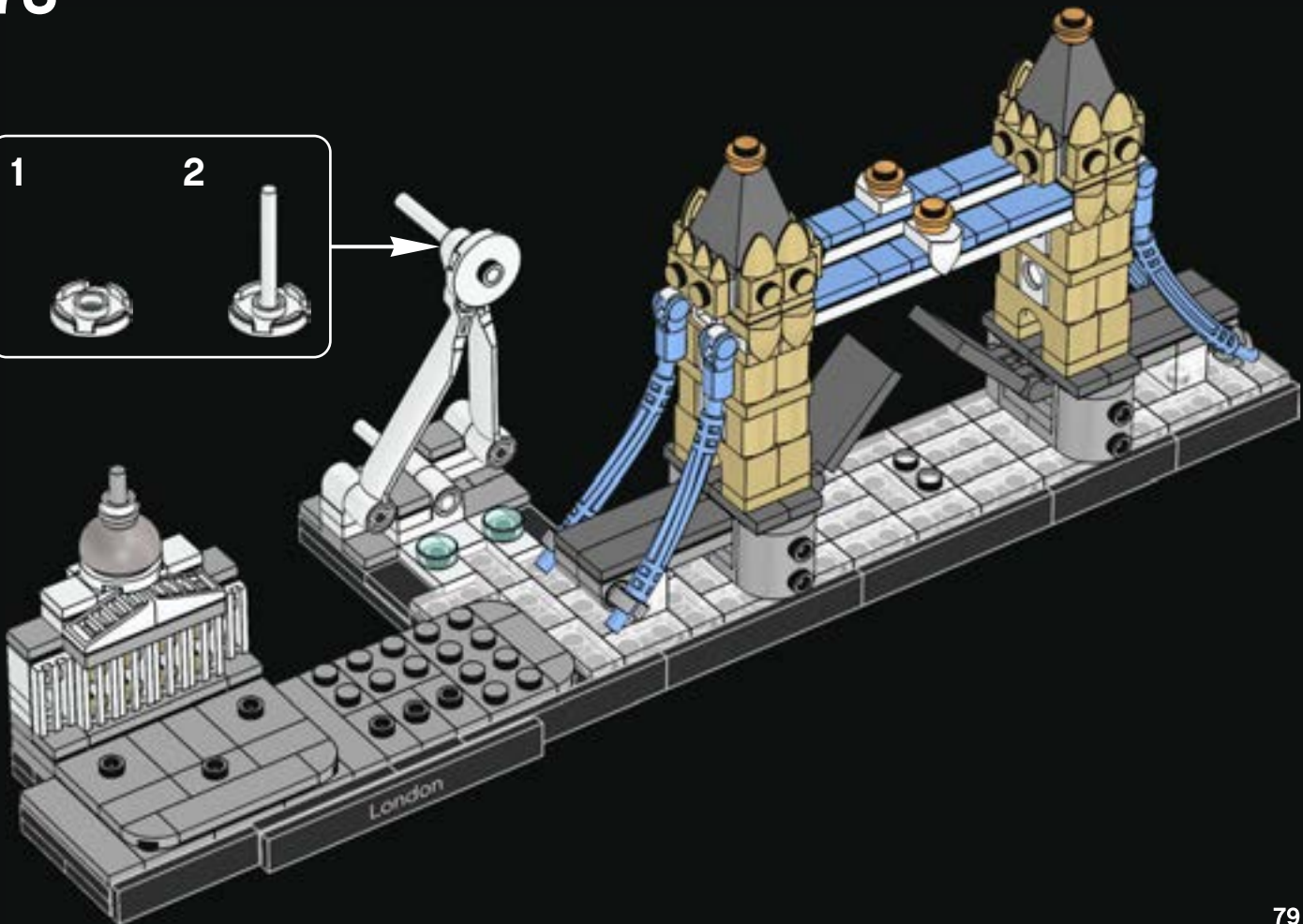
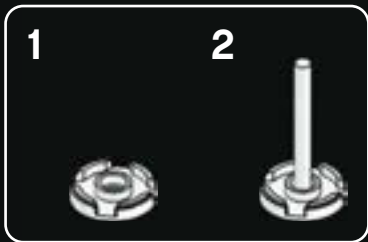



1x

74

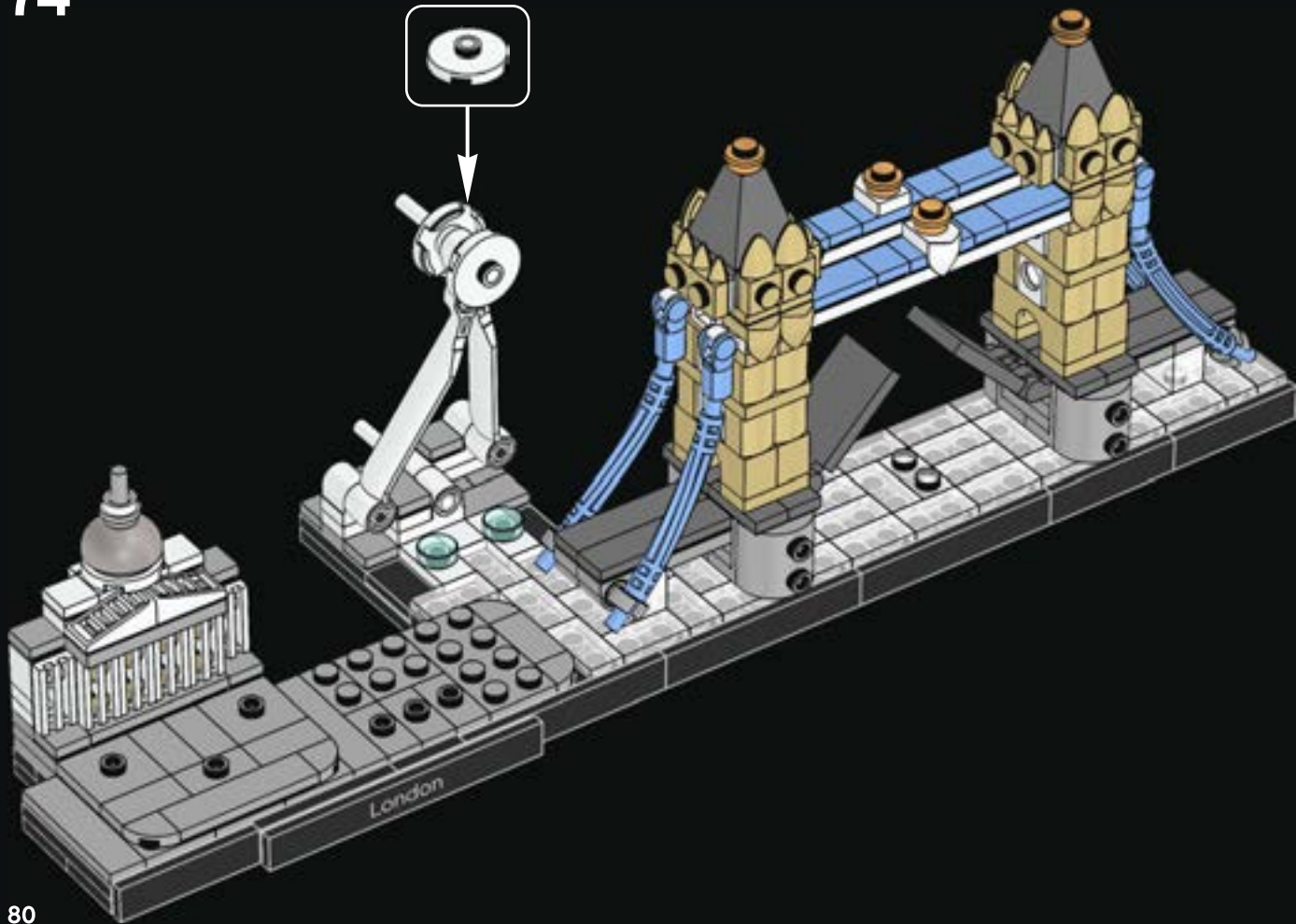

80



75



76



77



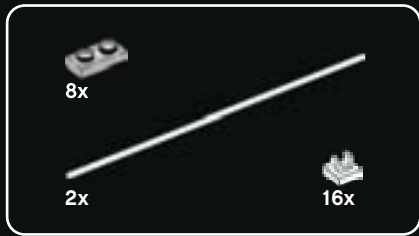

78

1



2



3



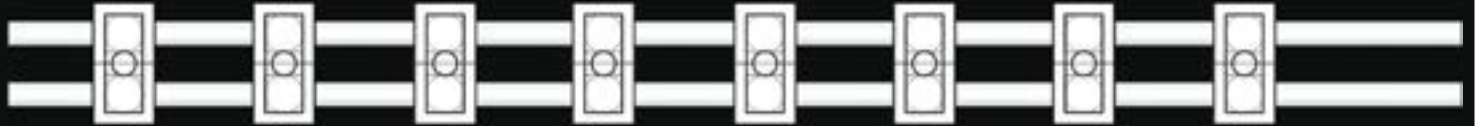

1:1

4

5

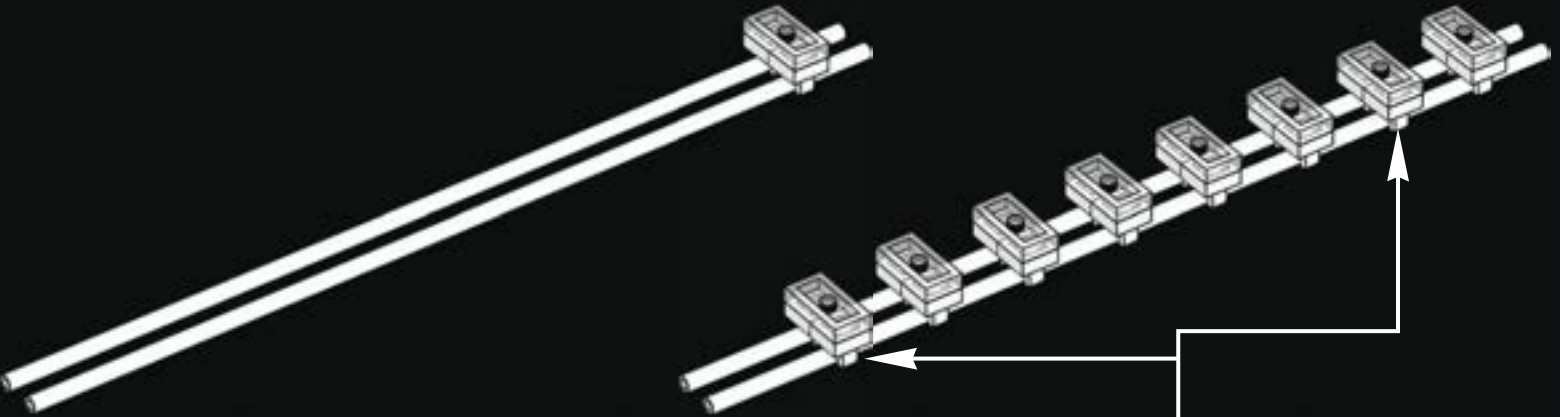

1 2 3

7x

2x

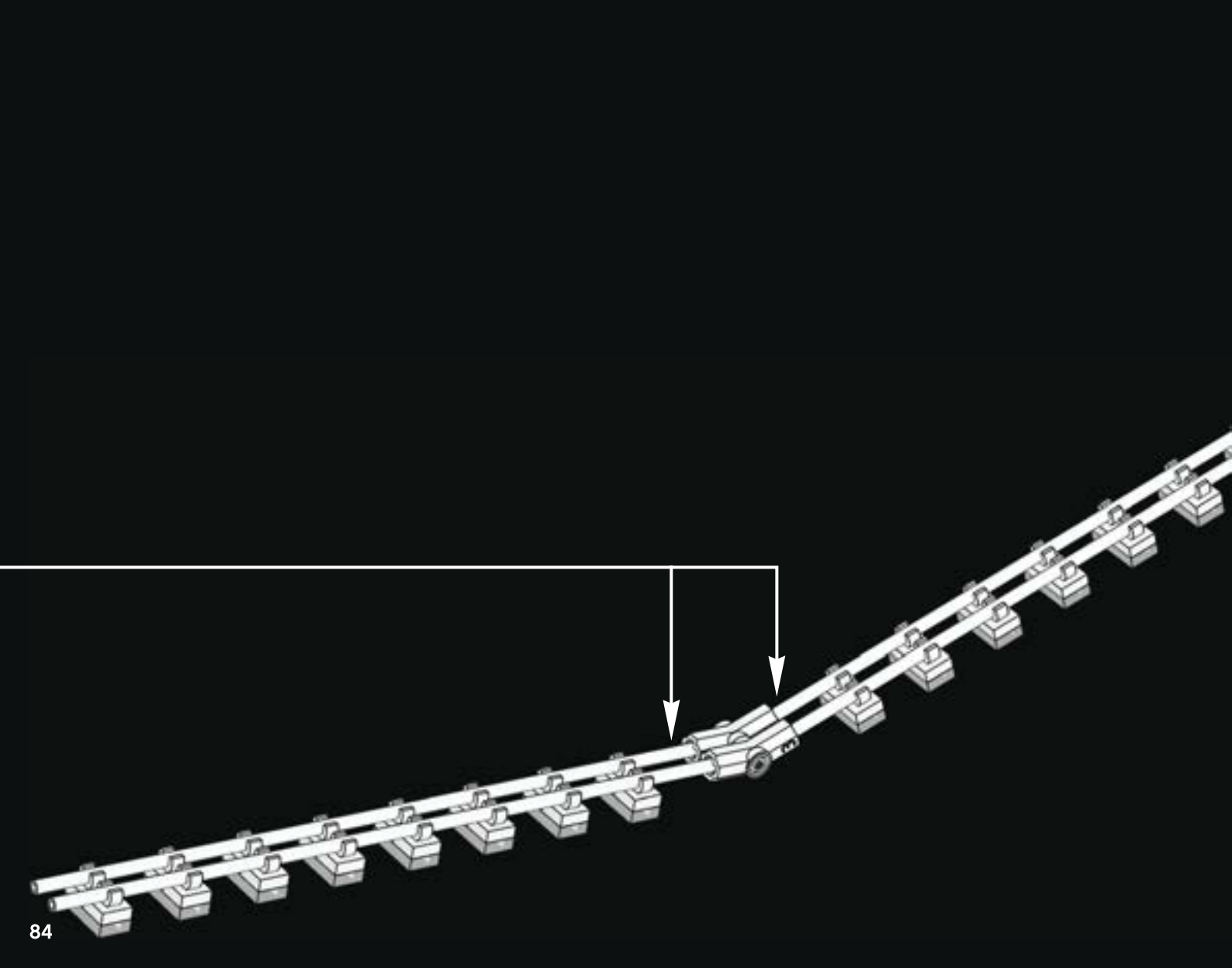



The London Eye has 32 capsules, one for each of the 32 London boroughs.



79



80

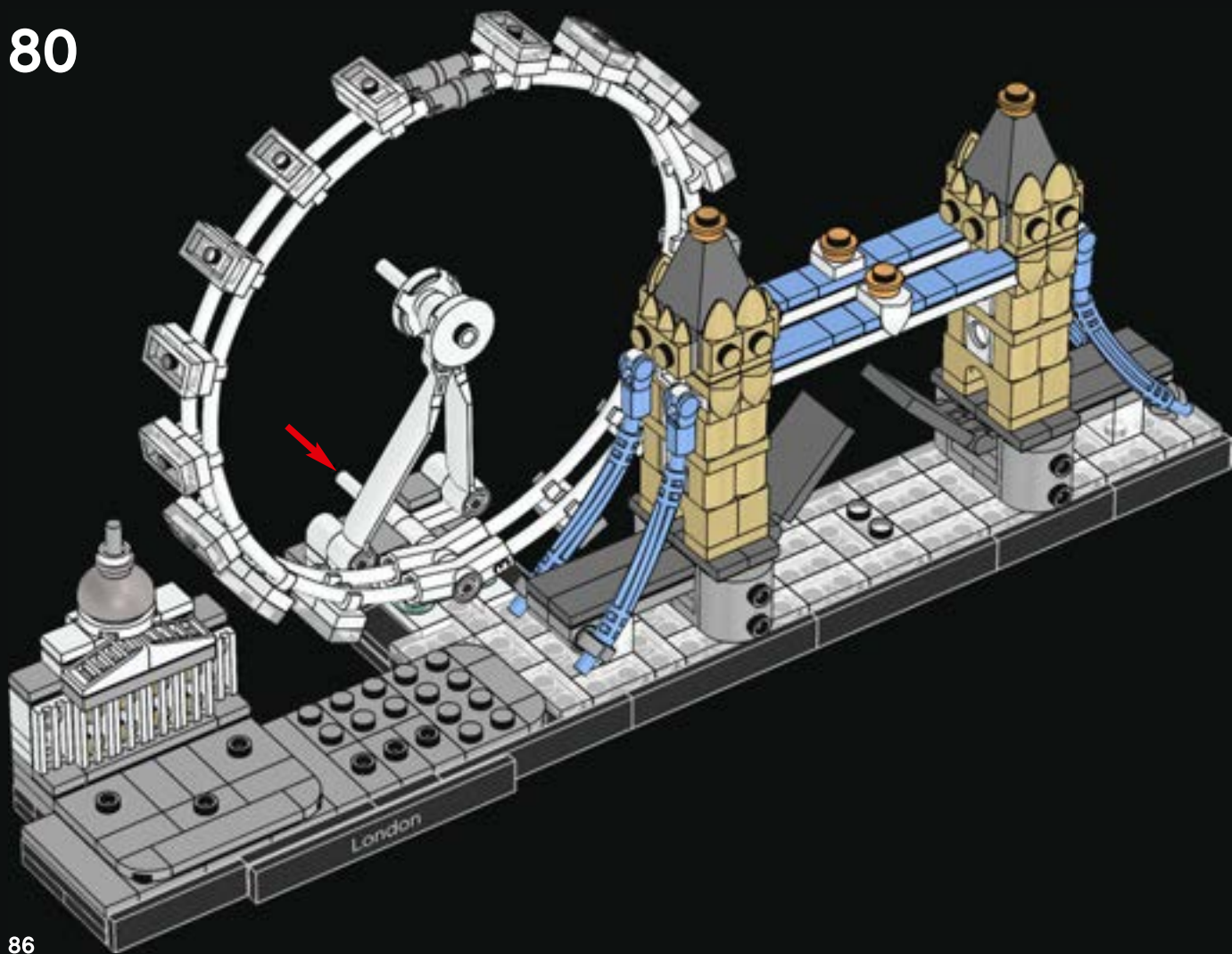

86

The London Eye can carry up to 800 people on each rotation.



81

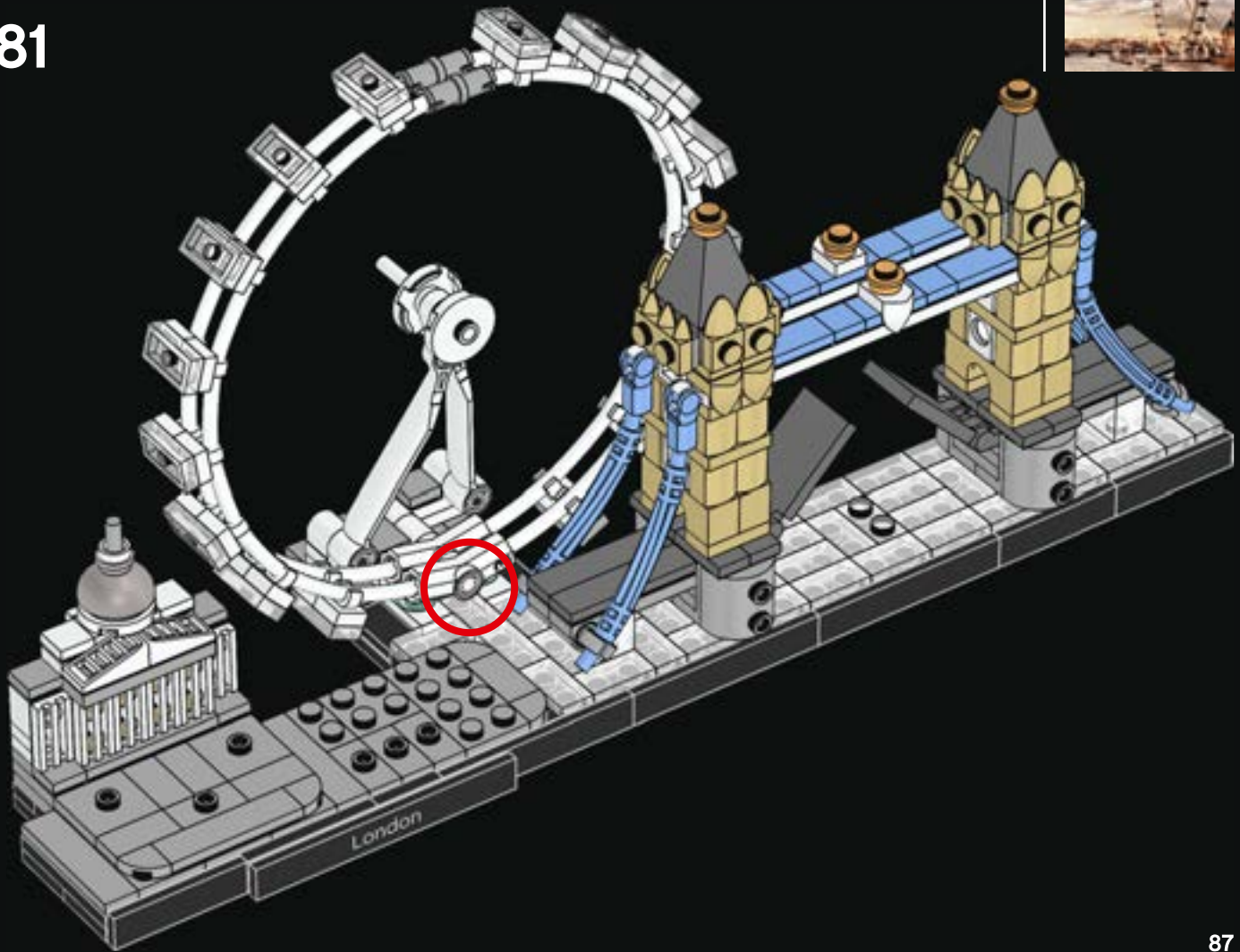



82

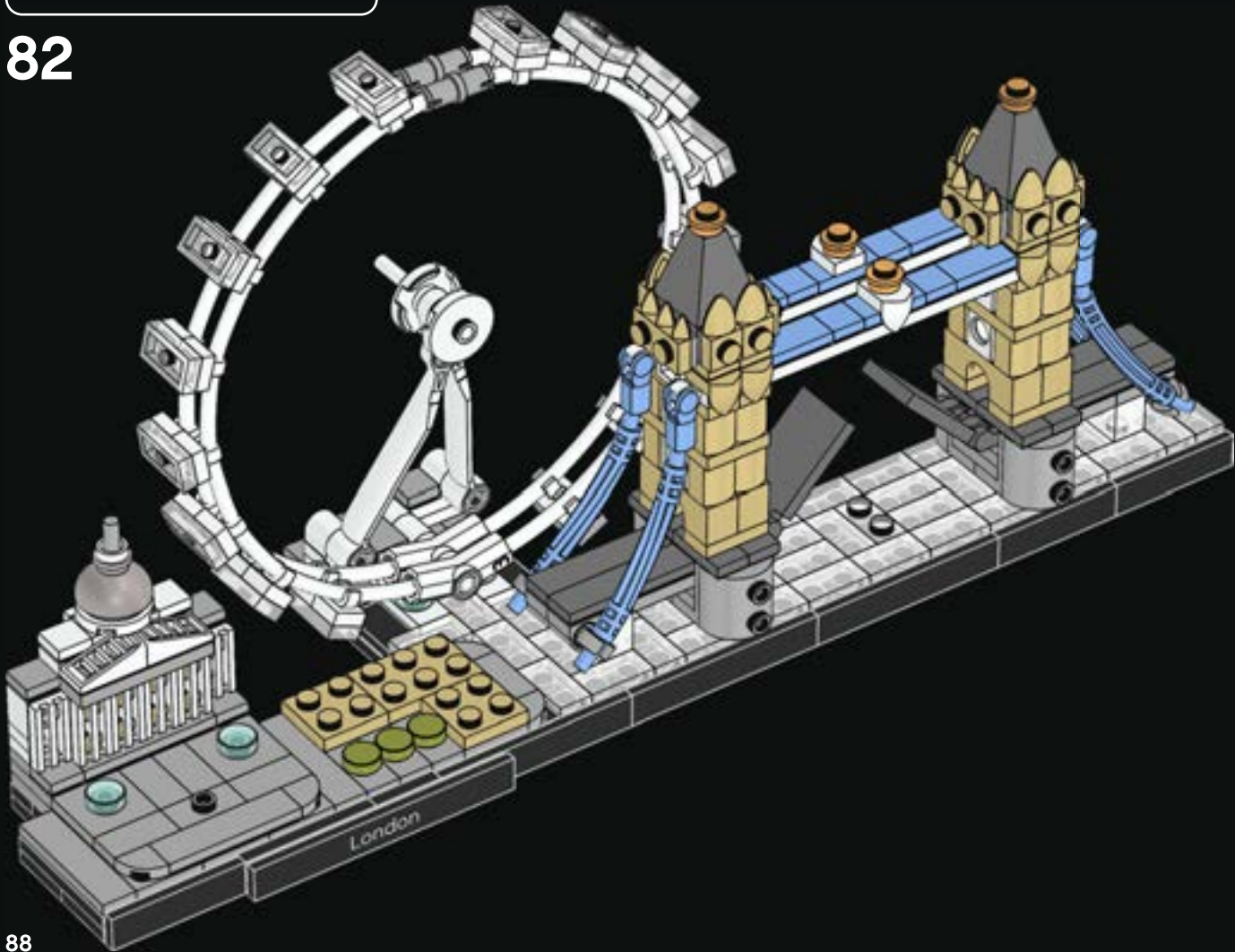



5x

83

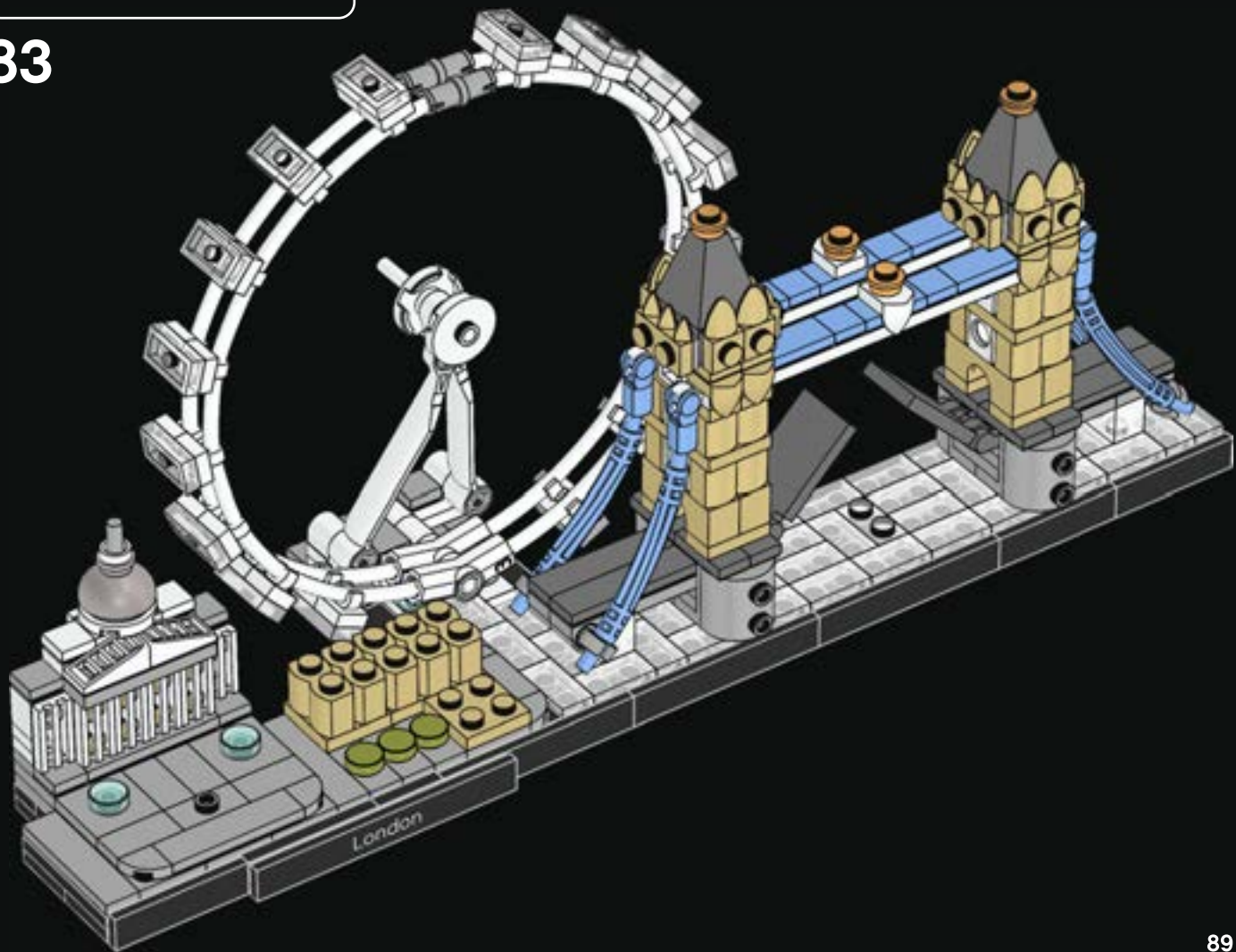



2x

84

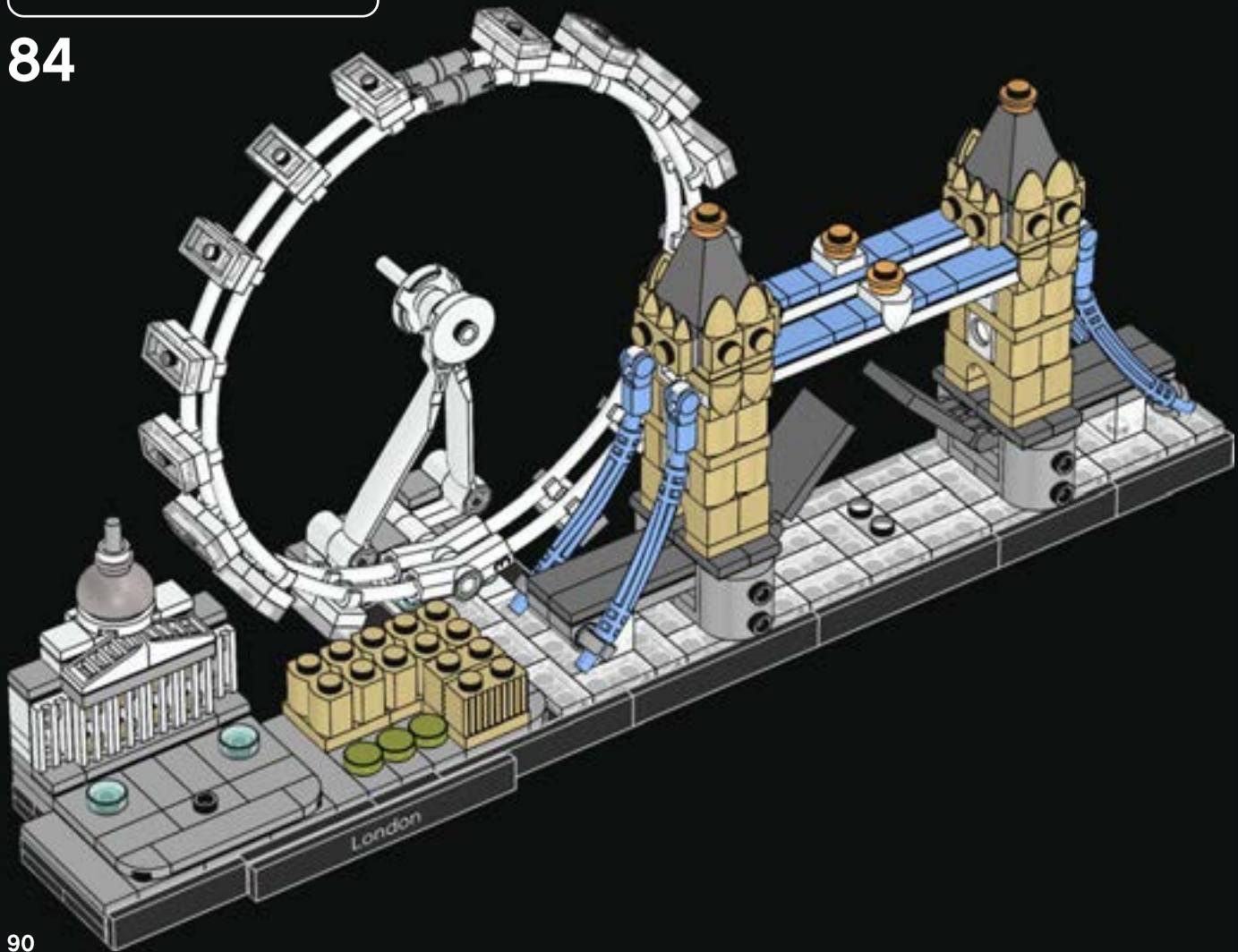

90



85



Anston stone from Yorkshire and granite from Cornwall were used on the exterior of the tower to clad the brickwork core.





5x

86

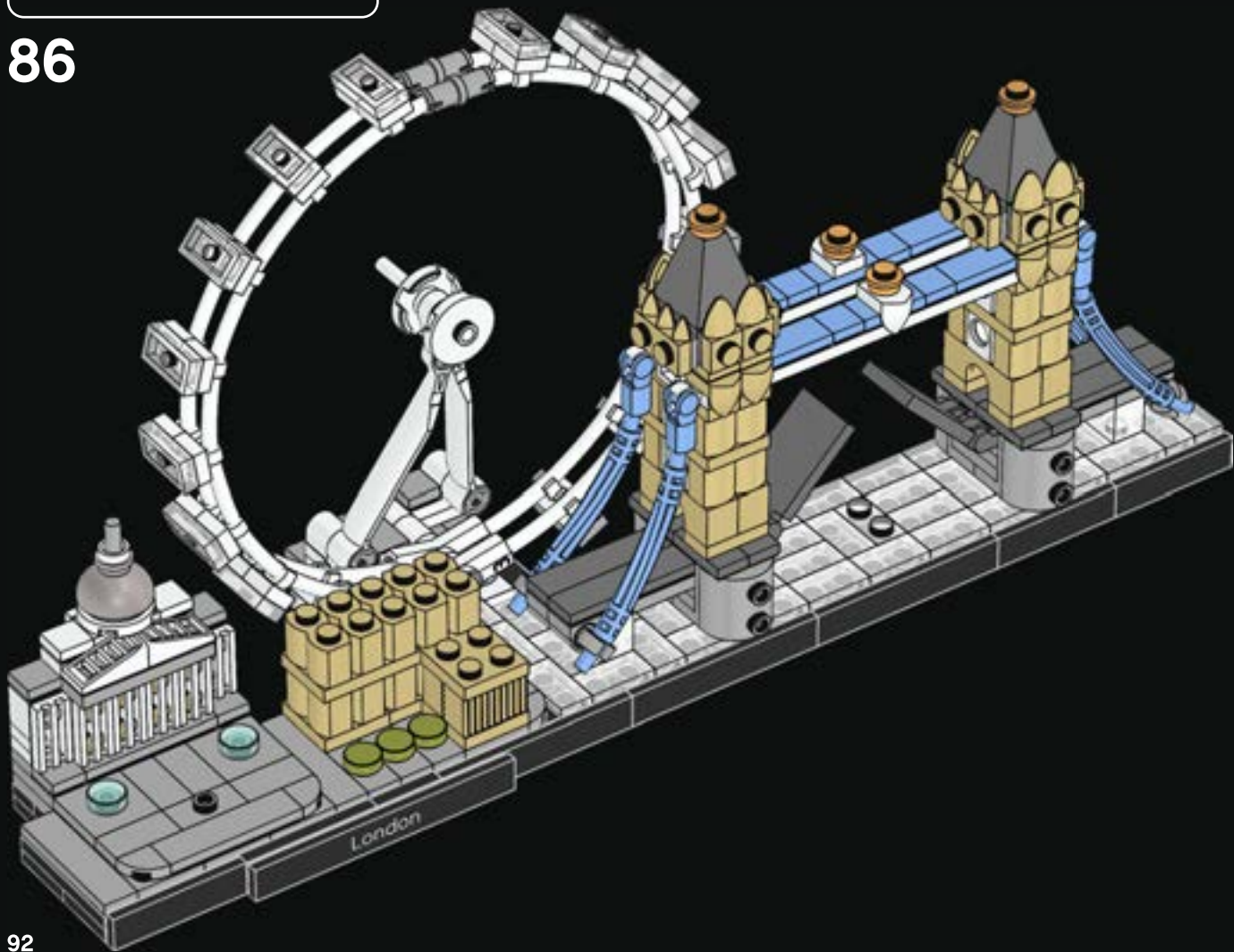

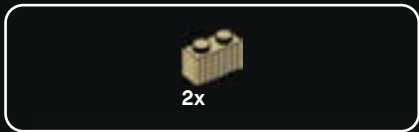

87

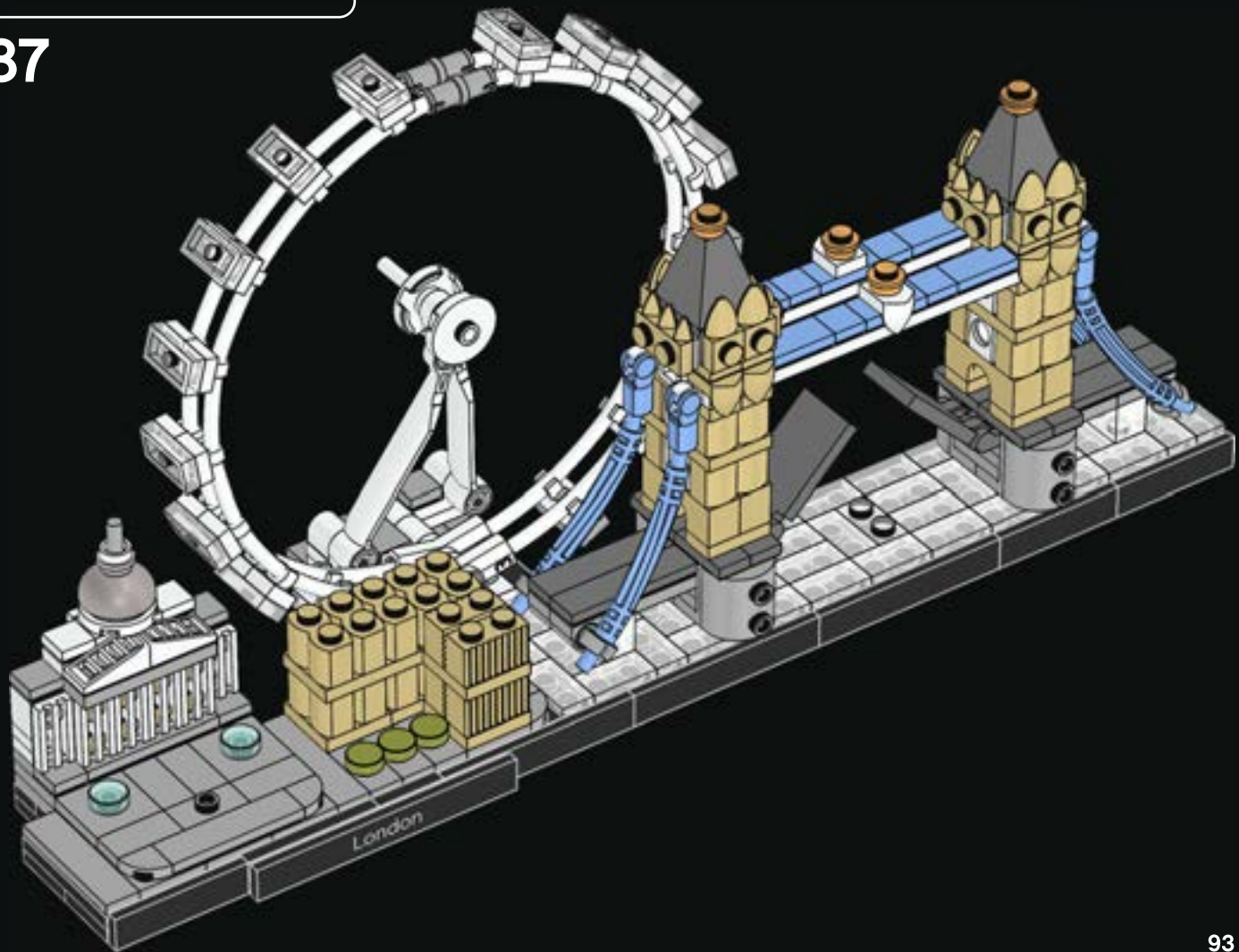



1x

88

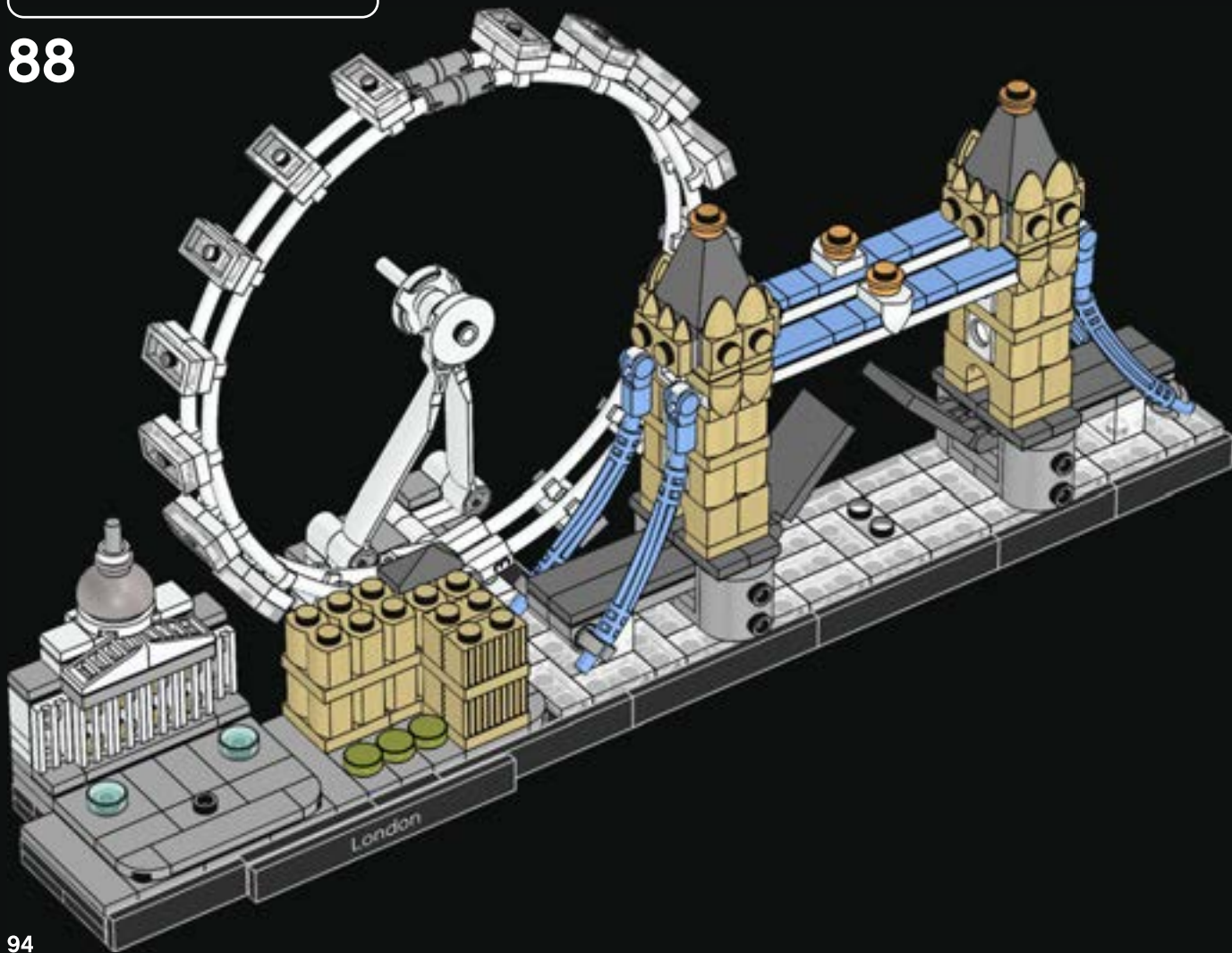

94



89

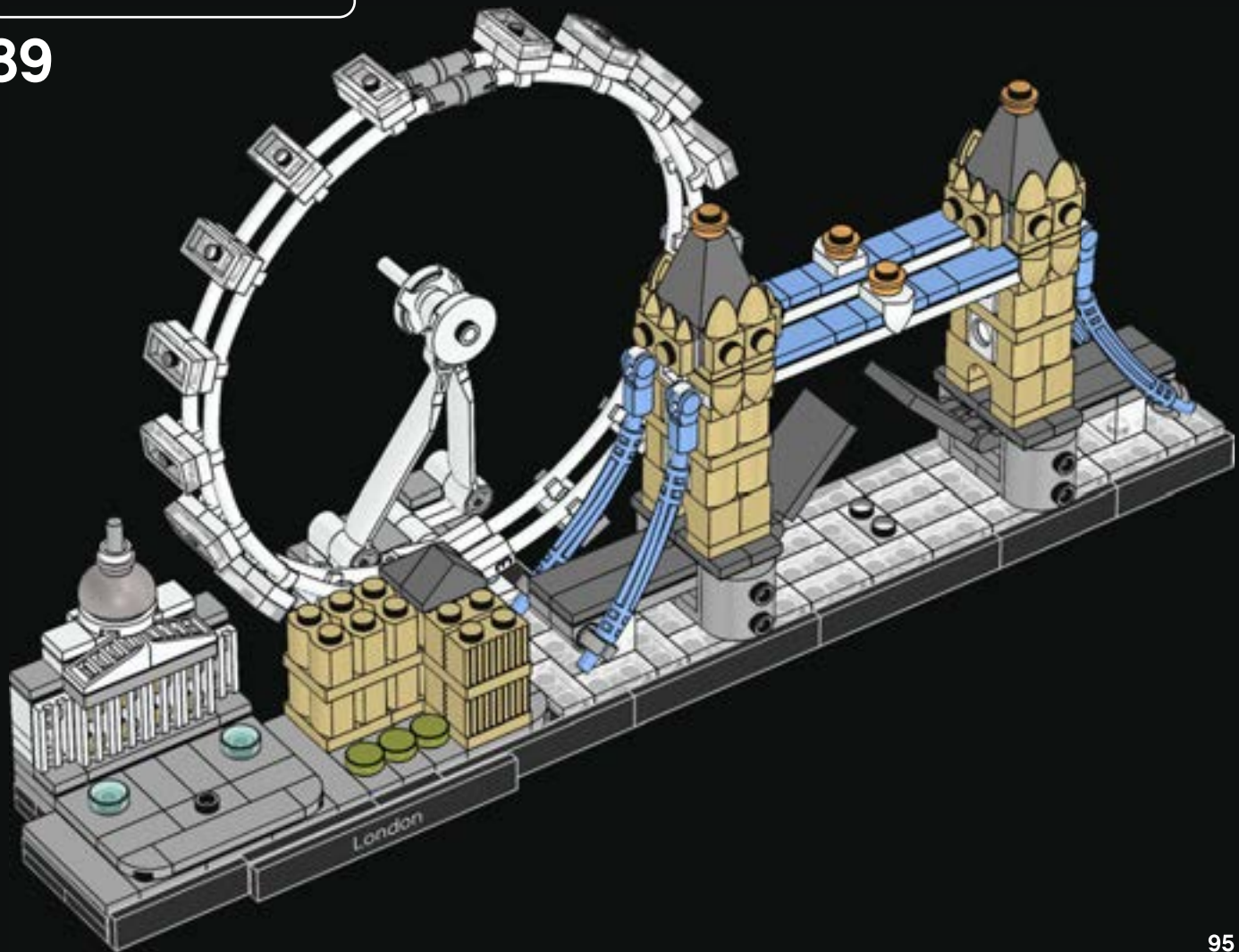

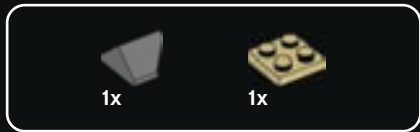

90

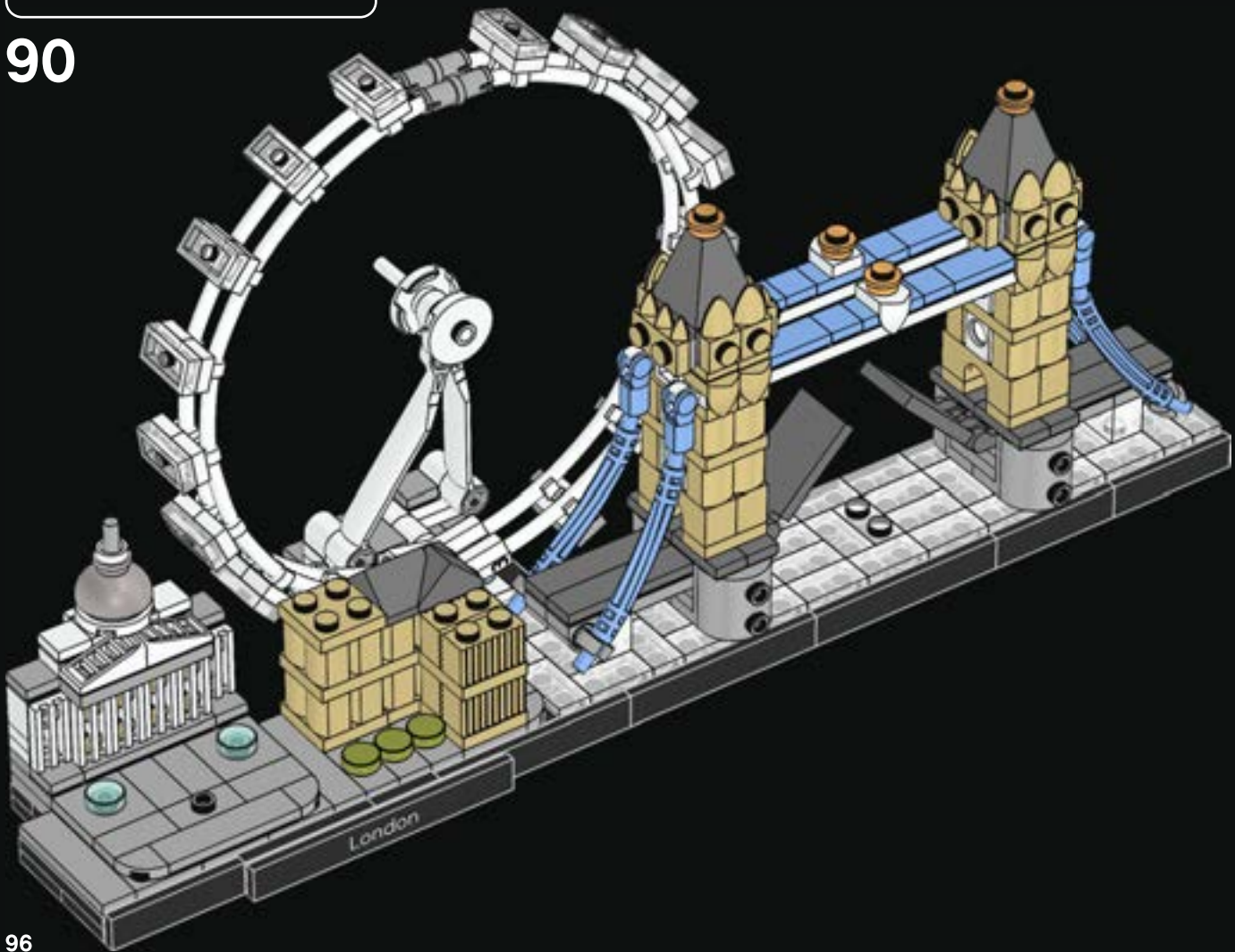

96



2x

91

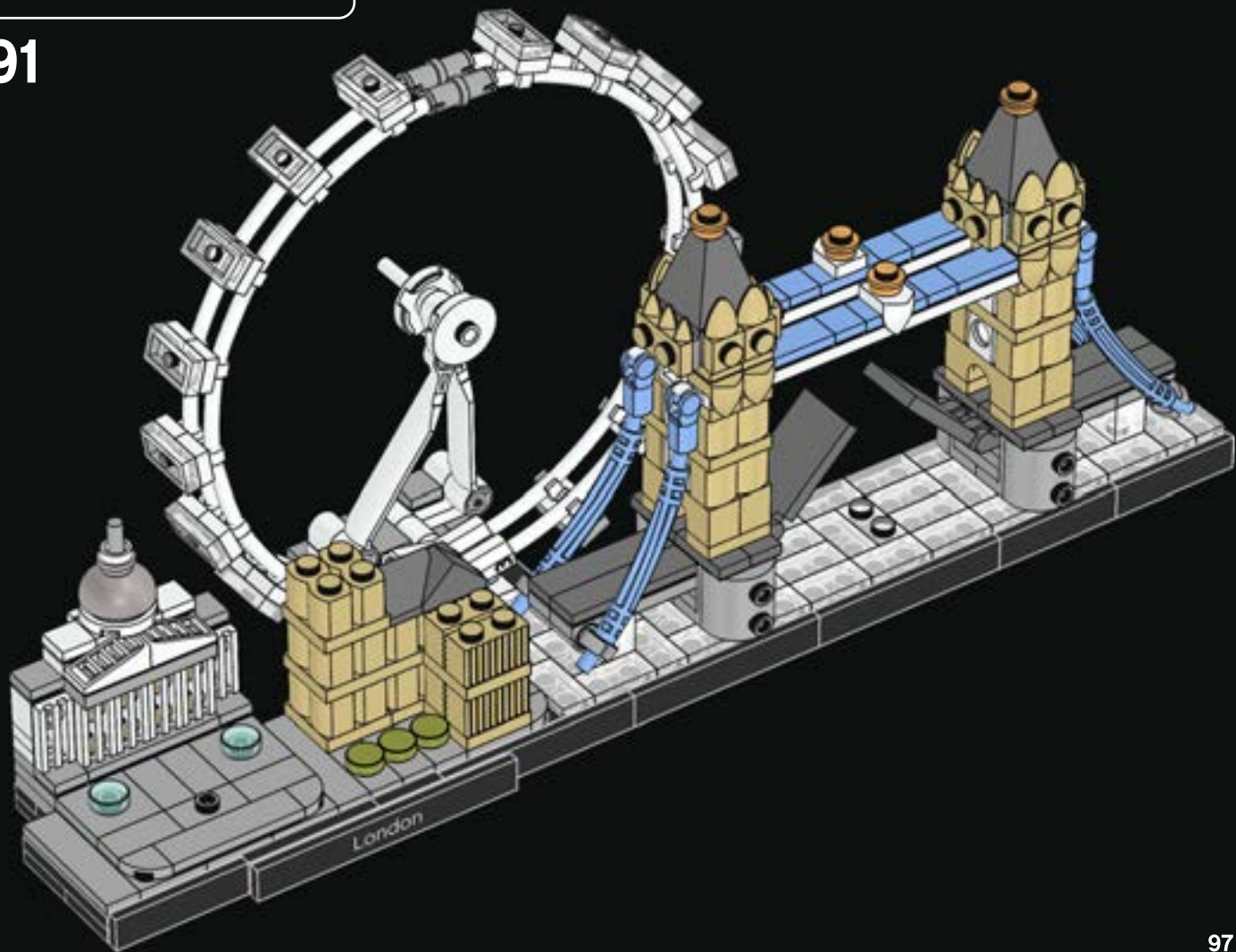



4x

92

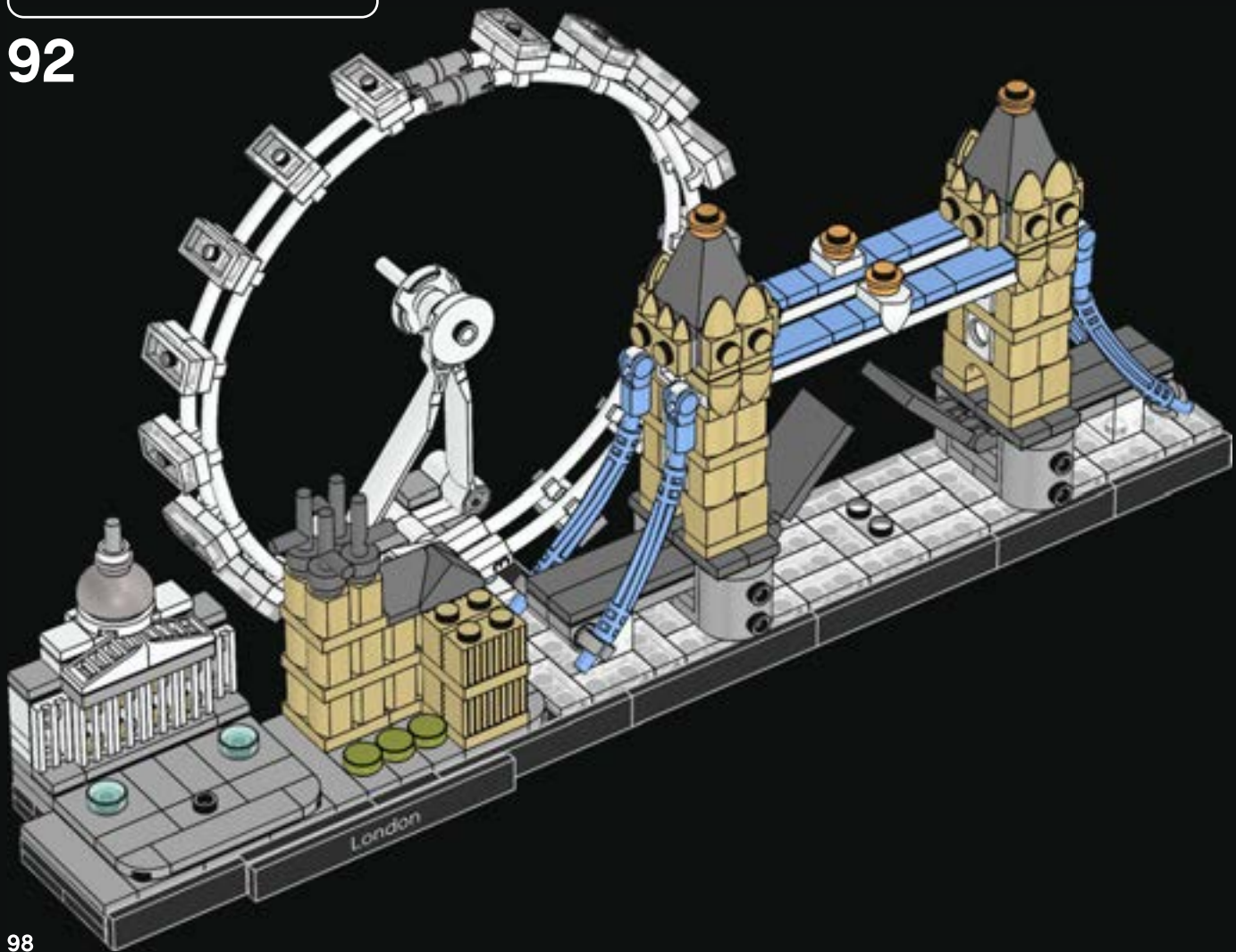

98



93

1



2



3



4



5



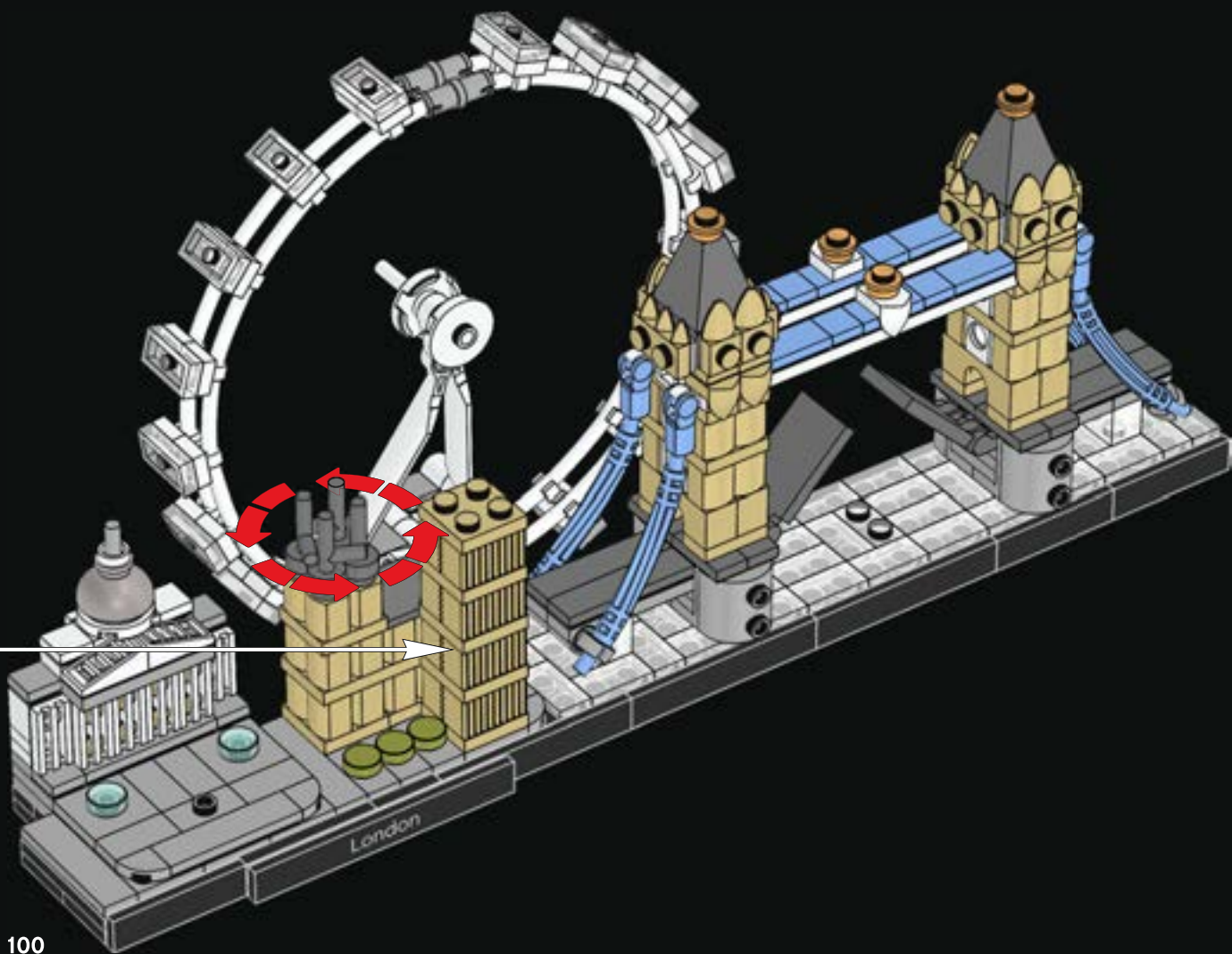



Under each clock dial there is a Latin inscription carved in stone that means "O Lord, keep safe our Queen Victoria the First."



94

1



2



3



4



5







95





1x



1x



96



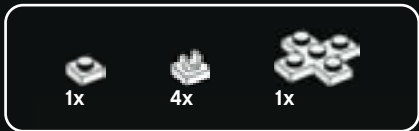

97

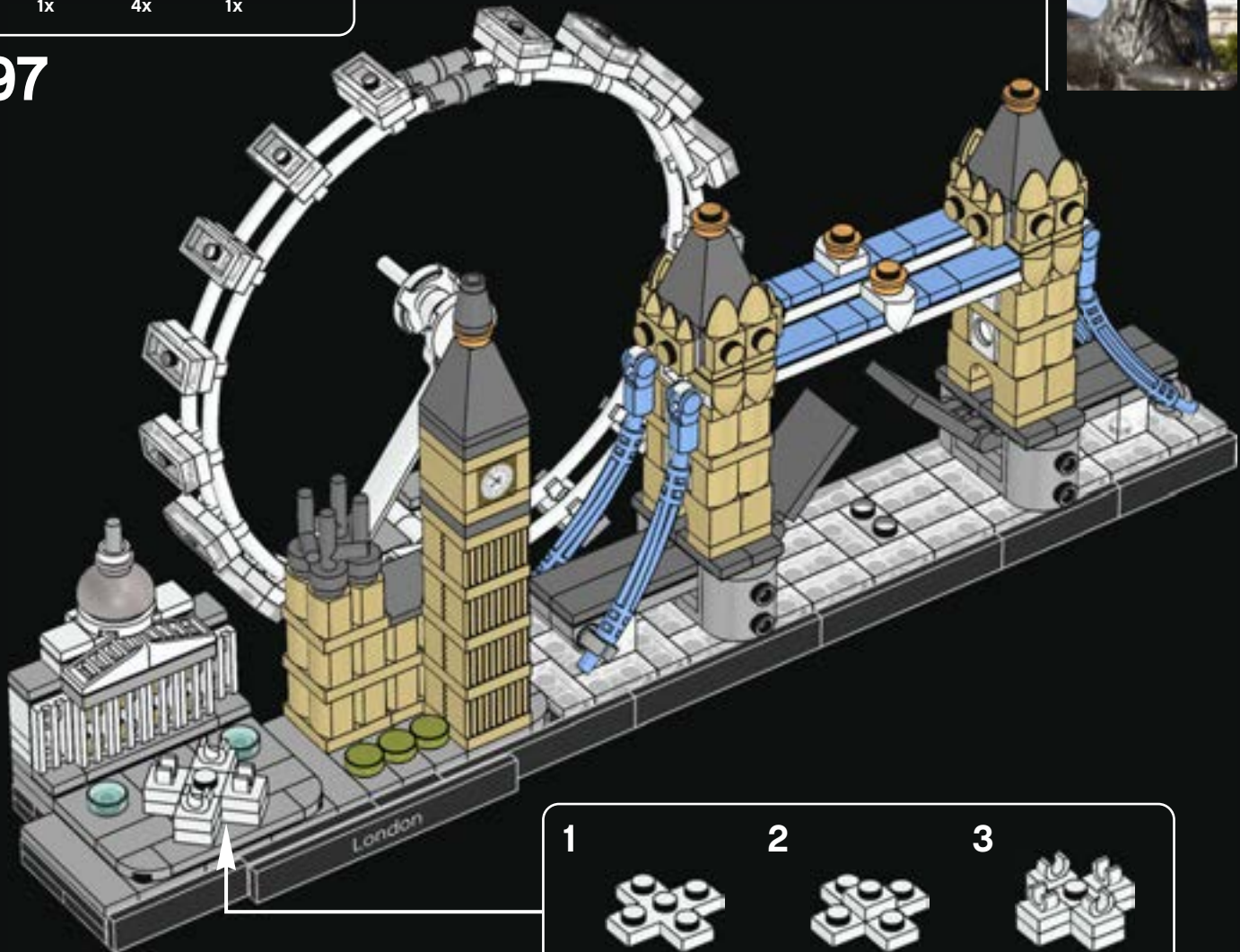

The four bronze lions at the base were added to Nelson's Column in 1867.





98

1



2



3



4



5



6



While the column is built in granite,
the statue of Nelson is made from
sandstone.

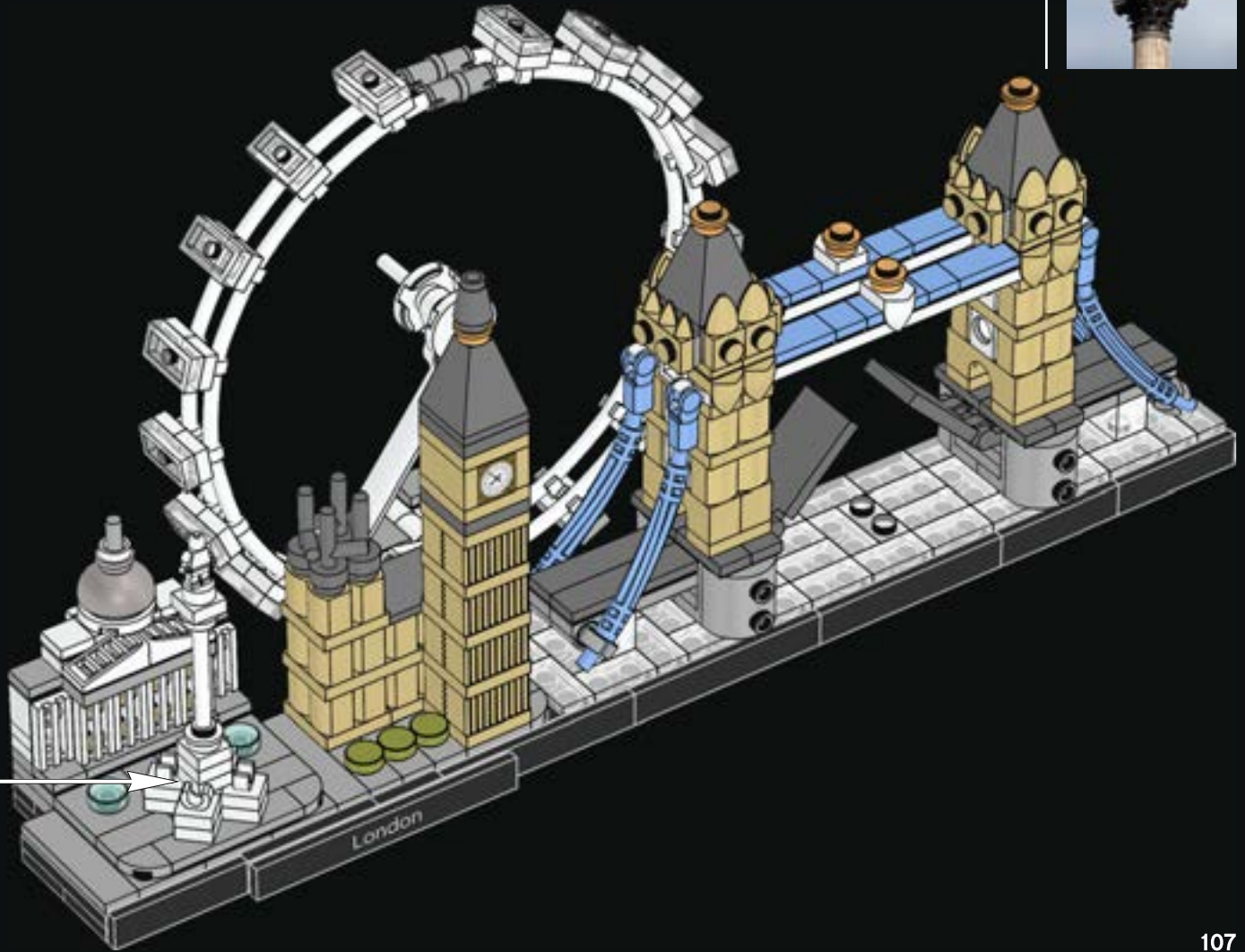



1x



1x

99

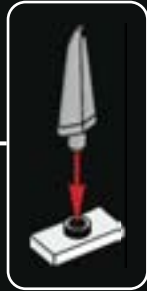
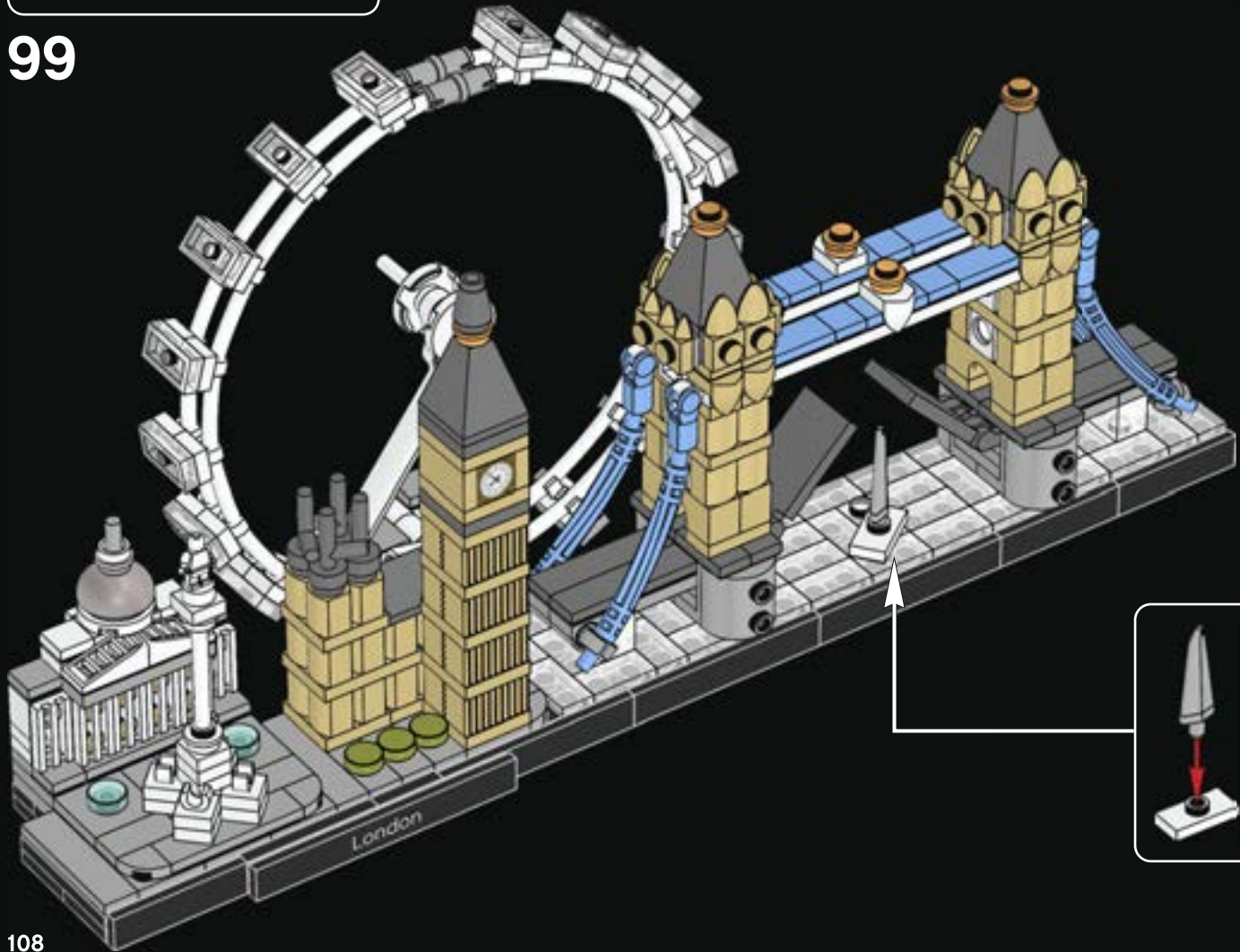

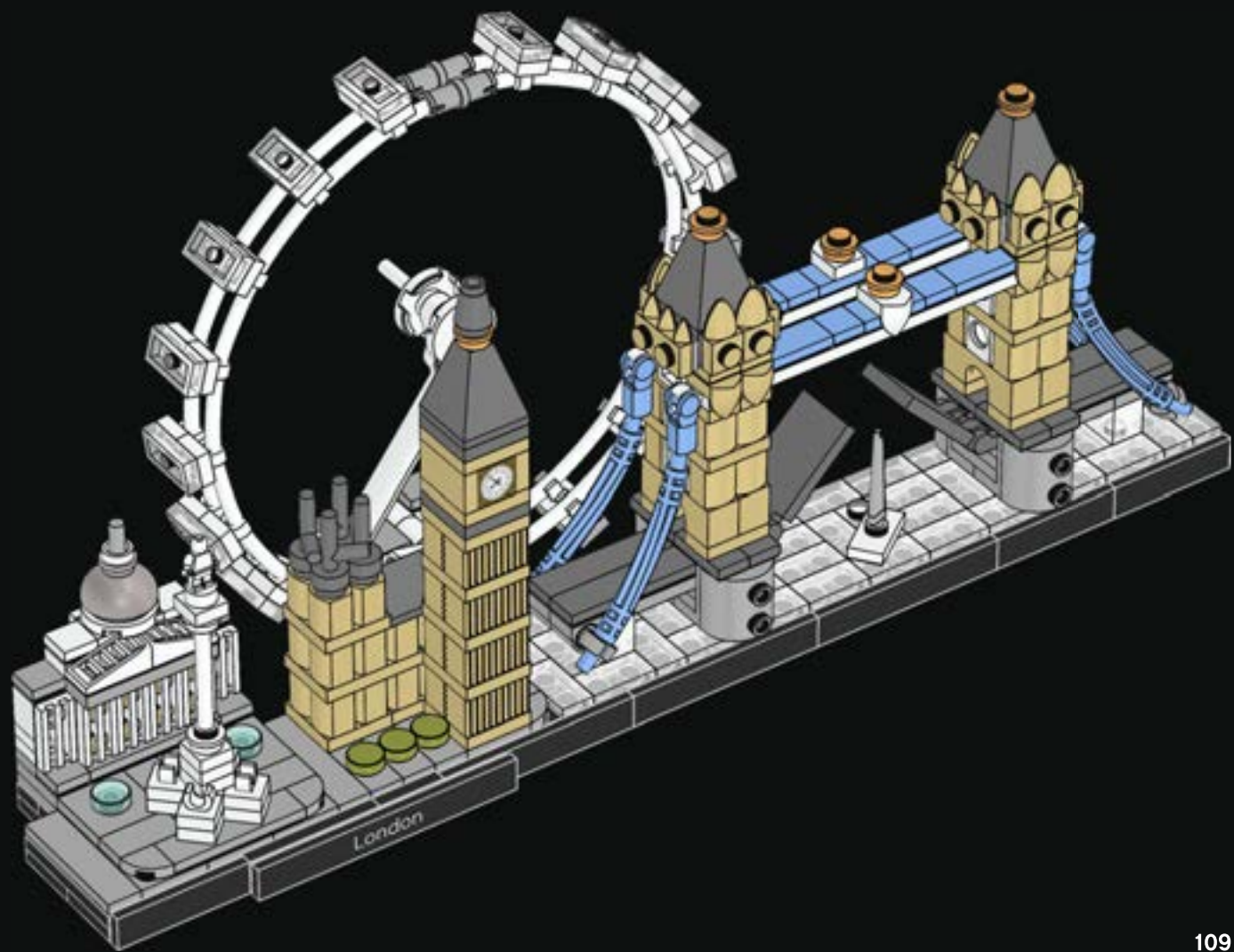



LEGO® Architecture – do you like it?

The LEGO Group would like your opinion on the new product you have just purchased. Your feedback will help shape the future development of this product series.

Please visit:

[LEGO.com/productfeedback](https://www.lego.com/productfeedback)

By completing our short feedback survey, you will be automatically entered into a drawing to win a LEGO® prize.



See website for official rules and details. Open to all countries where not prohibited.

LEGO and the LEGO logo are trademarks of the LEGO Group.
©2017 The LEGO Group.

LEGO® Architecture—then and now

There has always been a natural connection between the LEGO® brick and the world of architecture. Fans who build with LEGO elements instinctively develop an interest in the form and function of the structures they create. At the same time, many architects have discovered that LEGO bricks are the perfect way of physically expressing their creative ideas.

This connection was confirmed in the early 1960s with the launch of the LEGO 'Scale Model' line. It matched the spirit of the age where modern architects were redefining how houses look and people were taking an active interest in the design of their new homes. These sets were designed to be different from the normal, brightly colored LEGO boxes; they also included a book on architecture as a source of inspiration.

Decades later, architect and LEGO fan Adam Reed Tucker, revived the idea of expressing architecture using LEGO bricks and in partnership with the LEGO Group, launched the LEGO Architecture line that we know today.

His first models, and the original sets in the current LEGO Architecture series, were interpretations of famous skyscrapers from his hometown of Chicago. Since then LEGO Architecture has developed and evolved, first with well-known buildings from other cities in the United States, and now with iconic structures from Europe, the Middle East and Asia.

The introduction of our LEGO Architecture Studio set echoes the ambitions of the earlier LEGO 'Scale Model' line and widens the potential of the LEGO Architecture series. Now you can enjoy building and learning about specific landmark buildings, or create exciting architectural models from your own fantasy. An inspiring 270-page book, featuring a number of renowned architects from around the world, guides you through the principles of architecture and encourages you in your own creative building.



21050
Studio

Celebrate the world of architecture and collect all the models



21024
Louvre

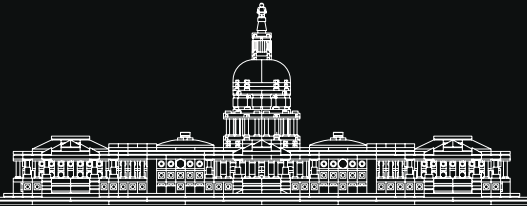

21030
United States Capitol Building

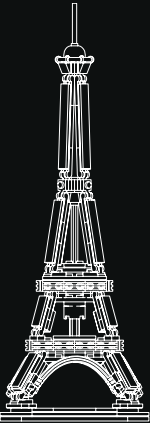

21019
The Eiffel Tower



21033
Chicago

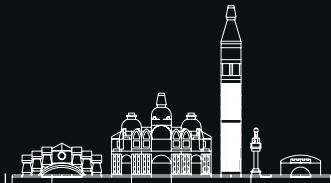

21026
Venice

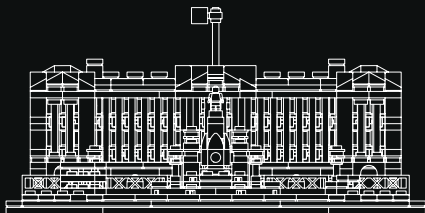

21029
Buckingham Palace

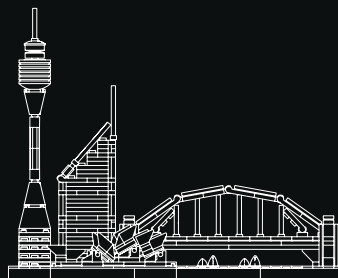

21032
Sydney



21027
Berlin



21028
New York City

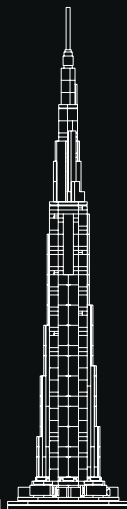

21031
Burj Khalifa

1x
6073432

3x
6168642

36x
6054551

6x
407001

7x
302401

4x
654101

3x
307001

2x
6046905

2x
6063767

4x
4538353

3x
6093053

4x
6058177

6x
241201

4x
6051511

4x
6057414

9x
302301

2x
6023804

1x
6099412

3x
6116602

1x
6156667

2x
6174941

2x
447701

2x
4612603

4x
4159553

4x
4125253

8x
6143058

8x
4224793

20x
4218749

8x
4655900

4x
6092587

4x
4113917

4x
6046907

8x
4114084

1x
6175701

2x
4121921

4x
4618651

4x
4118790

3x
4114309

1x
4143005

4x
4121715

3x
306926

12x
302326

2x
302226

1x
6052126

3x
302126

3x
243126

5x
371026

3x
663626

2x
379526

6x
4653049



1x
6174611



4x
346026



1x
303526



4x
244526



23x
4167842



2x
306540



40x
4569297



4x
6022171



4x
6178242



4x
4527526



2x
6092601



4x
4168345



4x
6178243



4x
4542590



4x
6176433



7x
4211415



4x
4211807



9x
4211414



6x
6066097



7x
4211398



4x
6089147



4x
4654580



4x
4654582



1x
6093527



2x
6126082



8x
4211397



1x
4211353



4x
6150310



1x
4616840



4x
4211356



4x
4211395



3x
4211452



1x
4529240



4x
4566028



1x
6076203



1x
4226221



1x
6174938



8x
6092572



4x
6000606



2x
4211094



3x
4645099



4x
4521187



4x
4211053



2x
4227517



5x
4523159



1x
6102756



3x
6047015



4x
6178597

References:

Pictures -

© Shutterstock

Text -

www.towerbridge.org.uk

www.parliament.uk

www.nationalgallery.org.uk

www.londoneye.com



 [LEGO.com/service](https://www.LEGO.com/service)

